

# Table of Contents

---

Click here to jump to Index by Description. Then click the description.

Click here to jump to Index by Part Number. Then click the part number.

Click on the Table of Contents below to jump to a sub-menu for a Section.

## Navigation Notes:

Hold down the <ALT> key and hit the <Back Arrow> to retrace your steps.

Click the Bookmarks listed on the left side to navigate to Sections and sub-menus.

<b>AXLES AND COMPONENTS</b> .....	<b>SECTION 1</b>
<b>WHEELS AND DRUMS</b> .....	<b>SECTION 2</b>
<b>AIR SYSTEMS</b> .....	<b>SECTION 3</b>
<b>SUSPENSIONS</b> .....	<b>SECTION 4</b>
<b>LANDING GEAR AND COMPONENTS</b> .....	<b>SECTION 5</b>
<b>COUPLERS AND HITCHES</b> .....	<b>SECTION 6</b>
<b>BODY COMPONENTS</b> .....	<b>SECTION 7</b>
<b>DOORS AND ACCESSORIES</b> .....	<b>SECTION 8</b>
<b>ELECTRICAL</b> .....	<b>SECTION 9</b>
<b>LIGHTS AND REFLECTORS</b> .....	<b>SECTION 10</b>
<b>FASTENERS</b> .....	<b>SECTION 11</b>
<b>SAFETY EQUIPMENT</b> .....	<b>SECTION 12</b>
<b>CARGO CONTROL</b> .....	<b>SECTION 13</b>
<b>TOOLS AND ACCESSORIES</b> .....	<b>SECTION 14</b>
<b>ADHESIVES, SEALANTS, AND TAPES</b> .....	<b>SECTION 15</b>
<b>LUBRICANTS AND CHEMICALS</b> .....	<b>SECTION 16</b>
<b>MISCELLANEOUS</b> .....	<b>SECTION 17</b>



3M - Discs & Abrasives	14-10
3M - Tapes, Adhesives, Sprays	15-8
<b>A</b>	
Accuride - Steel Wheels	2-11
Adapters & Bits	14-9
Air Chambers	3-7
Air Hose	3-5
Air Springs	4-17
Air Tanks	3-9
Air Tool Accessories	14-8
Air Tools	14-1
Air Valves	3-18
Air Valves - Generic	3-32
Alcoa - Aluminum Wheels	2-11
Aluminum Cleaner & Brightener	16-4
Aluminum Roofing	7-40
Aluminum Wheels	2-11
Anchorlok - Spring Brakes	3-7
Anti-Nose-Dive Jack	5-35
Apitong Flooring	7-51
Austin-Westran - Converter Dolly Jack	5-35
Austin-Westran - Landing Gear	5-15
Automix Adhesives	15-8
Axle Assemblies	1-2
Axle Nuts & Washers	1-18
Axles	1-1
Axles - Dana	1-1
Axles - Meritor	1-1/2
<b>B</b>	
Back-Up Alarms	12-15
Bags - Plastic w/ TM Logo	17-7
Banner - Oversize Load, Wide Load	12-11
Batteries - Duracell	9-15
Bearings & Races	1-19
Bendix - Air Valves	3-22
Bendix - ECU Valves	3-23
Bendix - Slack Adjusters	1-16
Bendix - Spring Brakes	3-7
Binders & Chains	13-9
Binkley - Landing Gear	5-1
Binkley - Suspensions	4-22
Bits & Adapters	14-9
Blades	12-12
Bolsters - Rear Frame	7-59
Bottom Rails	7-17
Bows - Roof	7-36
Boxes - Junction	9-6
Boxes - Record	17-1

Bracing - Landing Gear	5-27
Brackets - Mud Flap	12-2
Brake Drums	2-5
Brake Shoe Hardware	1-7
Brake Shoe Repair Kits	1-4
Brake Shoes	1-3
Brake Spider	1-6
Brass Fittings	3-12
Brooms	17-6
Brushes	17-7
Buck Rivets	11-3
Bumper Tubes	7-60
Bumpers - Rubber	12-7
Butler - Converter Dolly Jack	5-35
Butler - Landing Gear	5-7
Butler - Stabilizing Jack	5-35
<b>C</b>	
Cab Guards	13-10
Cable & Wire	9-7
Cable Ties	9-14
Cam Shaft Bushings & Brackets	1-13
Cam Shaft Repair Kits	1-11
Cam Shaft Washers, Lock Rings, & Seals	1-14
Cam Shafts	1-8
Camtainers, Mono Bolts, Pop Rivets	11-2
Caulking	15-1
Chains - Tire	12-14
Chains & Binders	13-9
Channels - Floor	7-50
Chemicals	16-4
Chicago Rawhide - Hub Caps	1-22
Chicago Rawhide - Oil Seals	1-21
Chock Blocks	12-7
Circuit Tester	9-14
Cleaner & Brightener	16-4
Coil Rack	13-11
Coiled Air Lines	3-6
Collars & Lock Bolts	11-1
Combination Lamps - Truck-Lite	10-38
Connectors - Male	9-1
Conspicuity Tape	12-14
Container Flooring	7-51
Converter Dolly Jacks	5-36
Corner Caps	7-4
Corner Irons	7-57
Corner Posts	7-58
Couplers	6-1
Crank Handles - Landing Gear	5-34
Creeper	14-11

# Index by Description



Crewson Brunner - Slack Adjusters	1-16
Crossmember Clips & Rail Kits	7-49
Crossmembers	7-47
Cylinders	17-4
<b>D</b>	
Dana - Axles	1-1
Dana - Oil Seals	1-21
Dana - Suspensions	4-58
Dayton - Leaf Spring	4-60
Decals - FHWA Inspection	12-10
Decals - Trailmobile Wing	17-3
Decals - Warning	12-10
Decking Beams	13-1
Disc Wheels	2-11
Dock Bumpers	12-7
Door Hold Backs	8-20
Door Locks	8-22
Doors - Overlay Sheets	8-1
Doors - Plymetal	8-1
Doors - Rear - Reefer	8-28
Doors - Seals & Retainers	8-2
Doors - Side - Dry Freight	8-32
Doors - Vents	7-62
Dorsey - Door Seal & Retainer	8-2
Dorsey - Hinge Butts	8-18
Dorsey - Hinge Pins	8-19
Dorsey - Hinges	8-6
Dorsey - Radius Panels	7-10
Dorsey - Roof Bows	7-37
Dorsey - Side Panels	7-27
Dorsey - Side Posts	7-24
Drain Cocks & Valves	3-11
Drawbar Eyes	6-3
Drill Bits	14-9
Drums	2-5
Duracell Batteries	9-15
Dust Shields	1-17
<b>E</b>	
E Track	13-1
ECU Valves - Bendix	3-23
ECU Valves - Haldex	3-24
ECU Valves - Meritor Wabco	3-25
Extinguishers	12-8
Eyes - Drawbar	6-3
EZ-In / EZ-Out Fasteners	11-5
<b>F</b>	
F Track	13-1

Fast Orange	17-3
Female Receptacles	9-2
Fenders - Tractor & Tanker	12-5
FHWA Inspection Form & Decal	12-10
Fiberglass - Lining Panels	7-32
Fiberglass - Scuff Liners	7-34
Fire Extinguishers	12-8
Firestone - Air Springs	4-16
First Aid Kit	12-15
Fittings - Brass	3-12
Flares	12-15
Flashers	9-12
Flip Placards	12-10
Floor Channels	7-50
Floor Restore Kits	15-4
Floor Screws	11-4
Flooring - Aluminum	7-52
Flooring - Apitong	7-51
Flooring - Container	7-51
Flooring - Laminated Hardwood	7-50
Foam Insulation	16-3
Fronts - Corner Caps	7-4
Fronts - Nose Posts	7-12
Fronts - Nose Rails	7-1
Fronts - Panels - Radius	7-6
Fronts - Posts - Nose	7-12
Fronts - Radius Panels	7-6
Fruehauf - Bottom Rails	7-18
Fruehauf - Hinge Butts	8-18
Fruehauf - Hinge Pins	8-19
Fruehauf - Hinges	8-8
Fruehauf - Nose Rails	7-3
Fruehauf - Radius Panels	7-9
Fruehauf - Roof Bows	7-37
Fruehauf - Side Panels	7-28
Fruehauf - Side Posts	7-24
Fruehauf - Suspensions	4-48
Fruehauf - Top Rails	7-15
Fusees	12-15
<b>G</b>	
Gabriel - Shock Absorbers	4-18
Gauge - King Pin	6-4
General Bearing - Bearings & Races	1-19
Generic Air Valves	3-32
Generic Dual Durometer Door Seals	8-4
Generic Todco Hardware	8-48
Generic Todco Rollers and Cables	8-47
Generic Todco Roll-Up Door Panels	8-40
Generic Todco Roll-Up Doors	8-39

Generic Truck-Lite Cross to Uni-Bond	10-41
Generic Whiting Hardware	8-59
Generic Whiting Rollers and Cables	8-60
Gindy - Hinges	8-9
Gindy - Side Posts	7-25
Gindy-Strick - Roof Bows	7-38
Gindy-Strick - Side Posts	7-25
Glad Hand Components	3-2
Glad Hands	3-1
Gloves	17-4
Grab Handles	7-63
Great Dane - Bottom Rails	7-19
Great Dane - Door Seal, Retainer, Slam	8-2
Great Dane - Hinge Butts	8-18
Great Dane - Hinge Pins	8-19
Great Dane - Hinges	8-10
Great Dane - Landing Gear Mnting Brckt	5-24
Great Dane - Nose Rails	7-3
Great Dane - Radius Panels	7-9
Great Dane - Roof Bows	7-37
Great Dane - Side Panels	7-28
Great Dane - Side Posts	7-24
Great Dane - Top Rails	7-15
Grote - Harnesses, Pigtales	10-4
Grote - Harnesses, Pigtales	10-4
Grote - Marker Lamps	10-1
Grote - Mounting Accessories	10-1
Grote - Replacement Lenses	10-6
Grote - Rubber Grommet	10-5
Grote - Stop, Turn, Tail Lamps	10-3
Grote - Utility, License Lamps	10-5
Gunitite - Slack Adjusters	1-16
<b>H</b>	
Hadley - Air Valves	3-26
Haldex - Air Valves	3-24
Haldex - Slack Adjusters	1-17
Hand Cleaner	17-3
Hand Jacks - Hydraulic	14-11
Handles	7-63
Harness Systems - Truck-Lite	10-20
Harnesses	9-13
Hayes Lemmerz - Steel Wheels	2-11
Headers - Rear Frame	7-57
Hendrickson - Air Valves	3-28
Hendrickson - Suspensions	4-5
Highway - Hinges	8-11
Hinge Butts	8-18
Hinge Pins	8-19
Hinges	8-5

Hoists	17-4
Hold Backs	8-20
Holland - Converter Dolly Jack	5-35
Holland - Landing Gear	5-9
Hose Separators & Springs	3-10
Hose-Tennas	3-11
Hub & Drum Assemblies	2-2
Hub Caps, Gaskets, & Plugs	1-21/22
Hubodometer Mounting Brackets	1-23
Hubodometers	1-24
Hubs	2-3
Huck Fasteners	11-1
Hug-A-Lug Nut Covers	2-14
Hutch - Suspensions	4-26
Hyatt - Bearings & Races	1-19
Hycy Hydraulic Cylinders	17-4
Hydraulic Hand Jacks	14-11
Hyundai - Hinges	8-12
<b>I</b>	
Insulation - Foam Kits	16-3
<b>J</b>	
Jack - Stabilizing Jack	5-35
Jacks - Hydraulic Hand	14-11
Jost - Landing Gear	5-11
Junction Boxes	9-6
<b>K</b>	
Kargo Patch	15-3
Kemlite Sun Patch	15-3
Kentucky - Hinges	8-12
King Pin Gauge	6-4
King Pin Locks	6-2
King Pins	6-2
Kwik Wipes	17-3
<b>L</b>	
Labels for Parts Bins	17-7
Laminated Wood Flooring	7-50
Lamps - Back-Up - Truck-Lite	10-33
Lamps - Cab Marker - Truck-Lite	10-36
Lamps - Identification Bar - Truck-Lite	10-36
Lamps - Marker - Grote	10-1
Lamps - Marker - Peterson	10-8
Lamps - Marker - Truck-Lite	10-22
Lamps - Marker - Uni-Bond	10-39
Lamps - Miniature	9-11
Lamps - Multi-Purpose - Truck-Lite	10-35
Lamps - Sealed Beam	9-9

# Index by Description



Lamps - Stop, Turn, Tail - Peterson	10-9
Lamps - Stop, Turn, Tail - Truck-Lite	10-27
Lamps - Stop, Turn, Tail - Uni-Bond	10-40
Lamps - Turn Signal - Truck-Lite	10-31
Lamps - Utility, License, Dome - Grote	10-5
Lamps - Utility, License, Dome - Peterson	10-9
Lamps - Utility, License, Dome - Truck-Lite	10-34
Landing Gear - Austin-Westran	5-15
Landing Gear - Binkley	5-1
Landing Gear - Bracing	5-27
Landing Gear - Butler	5-7
Landing Gear - Crank Handles	5-34
Landing Gear - Holland	5-9
Landing Gear - Jost	5-11
Landing Gear - Mounting Brackets	5-23
Landing Gear - Part Number Cross Ref	5-36
Landing Gear - Sand Shoes	5-31
Leaf Springs - Dayton High Arch	4-60
Leaf Springs - Fruehauf Suspensions	4-49
Leaf Springs - Hutch Suspensions	4-40
Leaf Springs - Reyco Suspensions	4-55
Leaf Springs - Trailmobile Suspensions	4-47
Light Mounting Brackets	7-61
Liner Panels	7-32
Lining - Fiberglass	7-32
Lining - Plywood	7-32
Load Locks	13-2
Lock Bolts & Collars	11-1
Locks - King Pin	6-2
Loctite - Permatex	15-5
Log Book	12-15
Logistic Straps	13-4
Logistic Track	13-1
Lubricants	16-1
Lufkin - Corner Caps	7-5
Lufkin - Side Posts	7-25
Lufkin - Top Rails	7-15
Lufkin A348- Roof Bows	7-38
<b>M</b>	
Male Connectors	9-1
Manac - Hinges	8-12
Manus Products	15-1
Markers - Yellow Opaque, Black	17-7
Meritor - Axles	1-1/2
Meritor - PSI Tire Inflation System	3-31
Meritor - Slack Adjusters	1-15
Meritor - Suspensions	4-57
Meritor Wabco - ECU Valves	3-25
MGM - Spring Brakes	3-7

Mid-Span Turn Signals - Safe-T-Signal	10-11
Miller - Hinges	8-13
Miller - Landing Gear Mounting Brkt	5-26
Miner - Hinge Butts	8-19
Miner - Hinge Pins	8-19
Miner - Hinges	8-13
Miniature Lamps	9-11
Mirrors	12-8
Modules - Truck-Lite	10-30
Mono Bolts, Camtainers, Pop Rivets	11-2
Monon - Corner Caps	7-5
Monon - Hinges	8-14
Monon - Landing Gear Mounting Brkt	5-26
Monon - Radius Panels	7-10
Morgan - Bottom Rails	7-42
Morgan - Corner Caps	7-44
Morgan - Hinges	7-45
Morgan - Radius Panels	7-43
Morgan - Rear Frame	7-45
Morgan - Roof Bows	7-43
Morgan - Side Posts	7-42
Morgan - Top Rails	7-41
MotorWheel - Steel Wheels	2-11
Mounting Accessories - Grote	10-1
Mounting Accessories - Truck-Lite	10-13
Mounting Brackets - Landing Gear	5-23
Mounting Brackets - Rear Lights	7-61
Mud Flap Brackets	12-2
Mud Flaps	12-1
Mylar Tape	7-49
<b>N</b>	
National - Oil Seals	1-21
Neway - Air Suspensions	4-1
Neway - Air Valves	3-27
Neway - Spring Suspensions	4-4
Newcourt - Tru-Sealer	8-3
Nose Boxes	3-10
Nose Posts	7-12
Nose Rails	7-1
Nut Covers	2-14
Nylon Rivets	11-5
<b>O</b>	
Oil Seal Interchange	1-20
Oil Seals	1-21
Overlay Sheets	8-1
Oversize Load Banner	12-11

<b>P</b>	
Panels - Liner	7-32
Panels - Radius	7-6
Panels - Side	7-26
Penske Yellow Spray Paint	7-46
Permatex - Loctite	15-5
Peterson - Marker Lamps	10-8
Peterson - Pigtail, Connector, Misc	10-11
Peterson - Reflectors	10-7
Peterson - Replacement Lenses	10-10
Peterson - Stop, Turn, Tail Lamps	10-9
Peterson - Utility, License, Dome Lamps	10-9
Phillips Bits	14-9
Pines - Corner Caps	7-5
Pines - Hinges	8-14
Pines - Landing Gear Mounting Brkt	5-25
Pintle Hooks	6-3
Placards	12-10
Plastic Bags w/ TM Logo	17-7
Plymetal Doors	8-1
Plywood	7-32
Plywood - Drive Rivets	11-5
Pogo Sticks	3-11
Pop Rivets, Camtainers, Mono Bolts	11-2
Posts - Corner	7-58
Posts - Nose	7-12
Posts - Side	7-21
Posts - Side Door	8-33
PSI Tire Inflation System	3-31
<b>R</b>	
Radius Panels	7-6
Rails - Bottom	7-17
Rails - Nose	7-1
Rails - Top	7-13
Ranger - Spring Brakes	3-7
Ratchet Straps	13-5
Rear Doors - Reefer	8-28
Rear Frame - Bolsters	7-59
Rear Frame - Bumper Tubes	7-60
Rear Frame - Corner Posts	7-58
Rear Frame - Light Mounting Brackets	7-61
Rear Frame - Top Headers	7-57
Receptacle Accessories	9-5
Receptacles - Female	9-2
Record Boxes	17-1
Reefer Rear Doors	8-28
Reefer Side Doors	8-35
Reefer Vents	7-62

Reflectors - Peterson	10-7
Reflectors - Truck-Lite	10-12
Registration Holders	17-1
Repair Kits - Kargo Patch, Sun Patch	15-3
Repair Panels - Adhesive-Backed Vanfastic	15-4
Replacement Lenses - Grote	10-6
Replacement Lenses - Peterson	10-10
Replacement Lenses - Truck-Lite	10-37
Retainers - Door	8-2
Reyco - Suspensions	4-50
Ridewell - Air Valves	3-26
Rims	2-12
Rivets - Buck	11-3
Rivets - Plywood Drive	11-5
Roller Door Lube	16-1
Roll-Up Doors - Complete - Generic Todco	8-39
Roll-Up Doors - Complete - Todco	8-39
Roll-Up Doors - Complete - Whiting	8-49
Roll-Up Doors - Conversion Kit from Swing	8-61
Roll-Up Doors - Fasteners	8-60
Roll-Up Doors - Hardware - Todco	8-43
Roll-Up Doors - Hardware - Whiting	8-57
Roll-Up Doors - Hrdware - Generic Todco	8-47
Roll-Up Doors - Hrdware - Generic Whiting	8-59
Roll-Up Doors - Panels - Generic Todco	8-40
Roll-Up Doors - Panels - Todco	8-40
Roll-Up Doors - Panels - Whiting	8-55
Roof Bows	7-36
Roof Sealants	15-2
Roofs - Aluminum	7-40
Roofs - Reinforcements	7-40
Roofs - Roof Bows	7-36
Roofs - Translucent	7-40
Rope - Rubber	13-9
<b>S</b>	
Safe-T-Signal - Mid-Span Turn Signals	10-11
Sand Shoes	5-31
Screws - Floor	11-4
Scuff - Aluminum	7-35
Scuff - Fiberglass	7-34
Scuff - Hardwood	7-35
Scuff - Steel	7-35
Scuff - Synthetic	7-34
Sealants - Roof	15-2
Sealco - Air Valves	3-18
Sealed Beam Lamps	9-9
Seals - Door	8-2
Seals - Door - DuraSeal	8-4
Seals - Door - Generic Dual Durometer	8-4

# Index by Description



Seals - Door - Sea-Lok	8-4
Security Seals	17-2
Sheets - Side	7-26
Shell Products	16-2
Shock Absorbers	4-18
Shop Towels & Rags	17-3
Shoring Beams	13-1
Side Doors - Dry Freight	8-32
Side Doors - Reefer	8-35
Side Panels	7-26
Side Posts	7-21
Side Sheets	7-26
Sides - Bottom Rails	7-17
Sides - Lining - Fiberglass	7-32
Sides - Lining - Plywood	7-32
Sides - Scuff - Aluminum	7-35
Sides - Scuff - Fiberglass	7-34
Sides - Scuff - Hardwood	7-35
Sides - Scuff - Steel	7-35
Sides - Scuff - Synthetic	7-34
Sides - Scuff Liners	7-34
Sides - Side Door Posts	8-33
Sides - Side Panels	7-26
Sides - Side Posts	7-21
Sides - Top Rails	7-13
Silaprene	15-1
Sky Lights	7-63
Slack Adjusters	1-15
Slick Disk	6-4
Slik-Pak	6-4
Spacer Bands	2-7
Spoke Wheels	2-1
Spray Paint	16-4
Spray Paint - Penske Yellow	7-46
Spring Brakes	3-7
Springs - Air	4-17
Springs - Leaf - Dayton High Arch	4-60
Springs - Leaf - Fruehauf Suspensions	4-49
Springs - Leaf - Hutch Suspensions	4-40
Springs - Leaf - Reyco Suspensions	4-55
Springs - Leaf - Trailmobile Suspensions	4-47
Stabilizing Jack	5-35
Starting Fluid	16-5
Steel Wheels	2-11
Stemco - Hub Caps, Gaskets, & Plugs	1-21
Stemco - Hubo Mounting Brackets	1-23
Stemco - Hubodometers	1-24
Stemco - Oil Seals	1-21
Steps	7-63
Stoughton - Bottom Rails	7-19

Stoughton - Corner Caps	7-5
Stoughton - Hinges	8-14
Stoughton - Radius Panels	7-10
Stoughton - Roof Bows	7-38
Stoughton - Top Rails	7-16
Straps - Logistic	13-4
Straps - Ratchet	13-5
Straps - Tarp	13-9
Straps - Winch	13-5
Strick - Corner Caps	7-5
Strick - Hinges	8-15
Strick - Radius Panels	7-10
Strick - Roof Bows	7-38
Strick - Side Posts	7-25
Sun Patch	15-3
Suspensions - Binkley	4-22
Suspensions - Dana	4-58
Suspensions - Fruehauf	4-48
Suspensions - Hendrickson	4-5
Suspensions - Hutch	4-26
Suspensions - Meritor	4-57
Suspensions - Neway	4-1
Suspensions - Reyco	4-50
Suspensions - Trailmobile	4-42
Swing Doors	8-1
Swing Doors - Overlay Sheets	8-1
<b>T</b>	
Tanker Fenders	12-5
Tanks	3-9
Tape - Conspicuity	12-14
Tape - Mylar	7-49
Tape of various sorts	15-3
Tapits	11-5
Tarp Bows	7-39
Tarp Straps	13-9
Tie-Downs	13-10
Timken - Bearings & Races	1-19
Tire Carriers	12-15
Tire Chains	12-14
Tire Inflation System	3-31
Todco - Roll-Up Door Hardware	8-43
Todco - Roll-Up Door Panels	8-40
Todco - Roll-Up Door Panels - Generic	8-40
Todco - Roll-Up Doors	8-39
Todco - Roll-Up Doors - Generic	8-39
Tool Boxes	13-11
Tools - Air	14-1
Top Rails	7-13
Torx Bits	14-9



Tractor Fenders	12-5
Tramec - Air Valves	3-26
Translucent Roofing	7-40
Triangle Kit	12-15
Triseal - Oil Seals	1-21
Truck Wash	16-4
Truck-Lite - Back-Up Lamps	10-33
Truck-Lite - Cab Marker Lamps	10-36
Truck-Lite - Combination Lamps	10-38
Truck-Lite - Harness Systems	10-20
Truck-Lite - Identification Bar Lamps	10-36
Truck-Lite - Marker Lamps	10-22
Truck-Lite - Modules	10-30
Truck-Lite - Mounting Accessories	10-13
Truck-Lite - Multi-Purpose Lamps	10-35
Truck-Lite - Reflectors	10-12
Truck-Lite - Replacement Lenses	10-37
Truck-Lite - Sockets, Plugs	10-18
Truck-Lite - Stop, Turn, Tail Lamps	10-27
Truck-Lite - Turn Signal Lamps	10-31
Truck-Lite - Utility, License, Dome Lamps	10-34
Tru-Sealer - Seals, Retainer	8-3

## U

U Bolts - Trailer	4-59
U Bolts - Truck Body	7-63
Under Frame - Crossmember Clips	7-49
Under Frame - Crossmembers	7-47
Under Frame - Floor Channels	7-50
Under Frame - Floors	7-50
Uni-Bond - Generic Truck-Lite Cross Ref	10-41
Uni-Bond - Marker Lamps	10-39
Uni-Bond - Stop, Turn, Tail Lamps	10-40
Uni-Taps	11-5
Upper Couplers	6-1
Utility - Bottom Rails	7-19
Utility - Hinge Pins	8-19
Utility - Hinges	8-16
Utility - Nose Rails	7-3
Utility - Radius Corner	7-11
Utility - Radius Corner Insert	7-11
Utility - Side Panels	7-28
Utility - Side Posts	7-25
Utility - Top Rails	7-16

## V

Valve Caps	2-13
Valve Stems	2-13
Valves	3-18
Valves - Generic	3-32

Vanfastic	15-4
Veeder-Root - Hubodometers	1-24
Veeder-Root - Mounting Brackets	1-23
Vents	7-62

## W

Wabash - Bottom Rails	7-20
Wabash - Hinge Butts	8-19
Wabash - Hinges	8-17
Wabash - Landing Gear Mounting Bracket	5-24
Wabash - Radius Panels	7-9
Wabash - Roof Bows	7-38
Wabash - Side Posts	7-25
Wabash - Top Rails	7-16
Washer Fluid	16-3
WD-40	16-1
Wheel Studs & Nuts	2-8
Wheel-Guard	2-14
Wheels	2-11
Whiting - Hardware - Generic	8-59
Whiting - Rollers and Cables - Generic	8-60
Whiting - Roll-Up Door Hardware	8-57
Whiting - Roll-Up Door Panels	8-55
Whiting - Roll-Up Doors	8-49
Wide Load Banner	12-11
Winch Bars	13-8
Winch Straps	13-5
Winches	13-7
Windshield Washer Fluid	16-3
Windshield Wiper Blades	12-12
Winter Chemicals	16-5
Wiper Blades	12-12
Wire & Cable	9-7
Wiring Harnesses	9-13
Wood Flooring	7-50

060X102X21	7-40
060X102X25	7-40
060X102X31	7-40
075X102X4	7-40
075X102X50	7-40
075X102X55	7-40
075X103X250	7-40
075X103X500	7-40
075X103X55	7-40
090X105X53	7-34
090X12X212	7-34
090X12X48	7-34
090X12X53	7-34
090X16X48	7-34
090X16X53	7-34
090X24X48	7-34
090X24X53	7-34
090X48X108	7-32
090X48X120	7-32
090X48X48	7-34
090X48X53	7-34
090X48X96	7-32
090X98X48	7-34
090X98X53	7-34
1029-4-158	9-5
1-0-5168-4-1	4-43
1-1-1033	4-42
11-1-176	12-7
11-1-248	12-7
11-1-305	12-7
11-1-326	12-7
11-1-369	12-7
11-1-375B-2-KIT	7-60
11-1-385B-GALV	7-60
1-125	7-51
1-125X5X16	7-51
1-125X7X15	7-51
1-125X7X16	7-51
1-14X24-HWD	7-50
1-14X48	7-50
1-14X48-HWD	7-50
1-15-1567	7-49
1-15-1569	7-49
1-15-1631	7-49
1-15-1632	7-49
1-18X24-HWD	7-50
1-18X48	7-50
1-18X48-HWD	7-50
1-18X52-HWD	7-50
11-A1-113	12-7

120X12X48	7-34
120X12X53	7-34
120X16X53	7-34
120X24X48	7-34
120X24X53	7-34
120X48X48	7-34
120X48X53	7-34
120X48X96	7-32
120X98X48	7-34
1-33-121	4-43
1-33-98	4-42/44
1-34-26	4-43/45
1-35-16	4-43
1-38-25	4-44
1-38-26	4-44
1-38WX52	7-50
1-38X14.5X52-HWD	7-50
1-38X24-HWD	7-50
1-38X48	7-50
1-38X48-HWD	7-50
1-38X52-HWD	7-50
1-3-965B	7-47
1-5/16X5X16	7-51
1-5/16X7X16	7-51
1511-A16-29	7-4
1511-A16-30	7-4
1511-A16-31	7-4
1511-A16-32	7-4
1-516	7-51
15-3-9	6-3
15-7-10	6-3
15-8-10	6-3
15-8-15	6-3
15-8-16	6-3
15-A27-1	6-3
17-12-351-117	3-5
17-12-351-129	3-5
17-12-351A	3-4
17-12-351B	3-4
17-14-100	3-2
17-14-135	3-3
17-14-28	3-1
17-14-29	3-1
17-14-4G	3-1
17-14-69	3-1
17-14-70	3-1
17-14-73	3-1
17-14-74	3-1
17-14-79	3-1
17-14-80	3-1

17-14-99	3-2
17-17-122	3-3
17-25-8	3-10
17-3-31	3-11
17-37-36	3-7; 6-3
17-4-45	3-10
17-4-54	3-10
17-4-64	3-10
17-5-147	3-4
17-69J-1	3-6
17-69J-1-100	3-6
17-69J-5	3-6
17-69J-5-100	3-6
17-69J-5-B	3-6
17-69J-5-B-100	3-6
17-69J-5-R	3-6
17-69J-5-R-100	3-6
17-69J-6	3-6
17-69J-6-100	3-6
17-69J-6-B	3-6
17-69J-6-B-100	3-6
17-69J-6-R	3-6
17-69J-6-R-100	3-6
17-69J-7	3-6
17-69J-7-100	3-6
17-69J-8	3-6
17-69J-8-100	3-6
17-69J-9	3-6
17-69J-9-100	3-6
17-7-190	3-26
17-8-50	3-9
17-8-54	3-9
17-8-55	3-9
17-A23-100	1-15
17-A23-101	1-15
17-A23-112	1-15
17-A23-66B	1-15
1-A33-29	4-45
1-A33-30	4-45
1-A33-32	4-44
1-A33-44	4-42/44/45
1-A34-6	4-42/45
1-A34-9	4-44
1-A38-5	4-42/44
1-A38-8	4-43
1-A38-8-1	4-43
1X040X49X110W-PVC	7-30
1X040X49X93W-PVC	7-30
1X050X49X110BARE	7-30
1X050X49X110BLK-PVC	7-30

# Index by Part Number



1X050X49X110PCR-PVC	7-30
1X050X49X110PPAVG	7-30
1X050X49X110PPW	7-30
1X050X49X110PPW/G	7-30
1X050X49X110PPW-50PC	7-30
1X050X49X110W-PVC	7-30
1X050X49X115PPMB	7-30
1X050X49X120PPW	7-30
1X050X49X120UPS	7-30
1X050X49X120W-PVC	7-30
1X050X49X123BARE	7-30
1X050X49X123PPW/G	7-30
1X050X55X120PPW	7-30
1X063X49X123BARE	7-30
20-1-22	6-3
20-1-26	6-3
20-1-28	6-3
2-0-365-36	6-1
2-0-365-36-1	6-1
21-A5-11	5-35
2-52-40	6-2
2-52-41A	6-2
2-52-42A	6-2
29-2-121	9-4
29-26-50	9-6
29-2-67	9-2
29-2-89	9-2
29-30-16	9-14
29-3-368	9-13
29-3-393-12	9-13
29-3-398	9-13
29-3-405	9-13
29-3-451A-530-1A	9-13
29-3-452-48	9-13
29-3-484	9-13
29-4-317L	7-61
29-4-317R	7-61
29-4-318L	7-61
29-4-318R	7-61
29-4-351L	7-61
29-4-351R	7-61
29-4-461C	7-63
29-4-475	9-5
29-A2-46	9-4
29-A2-47	9-4
29-A4-101-2A	7-61
29-A4-102-2A	7-61
29-A4-132-2	7-61
29-A4-132-2-6	7-61
29-A4-132-3	7-61

29-A4-132-3-6	7-61
29-A4-94-2	7-61
29-A4-95A-2	7-61
2-A51-86A-1	6-1
3/16" X 3/8"	11-3
3-12-16	4-47
3-12-17	4-47
3-16-16A	4-42/44
3-16-16B	4-44
3-16-26-2	4-44
3-16-33A	4-44
3-16-33B	4-42/44
3-16-38	4-43/44
32-2-19	7-63
3-23-9	4-59
33-1-198	17-3
33-1-228	12-10
33-1-228A	12-10
33-1-255	17-3
3-34-33	4-47
3-73-38	4-60
392-752-62A-16	7-27
392-752-62C-16	7-27
392-752-62D-16	7-27
392-752-62E-16	7-27
392-752-62H-16	7-27
3-A1-16	4-45
3-A11-64	4-46
3-A11-65A	4-46
3-A1-17	4-45
3-A11-74G	4-46
3-A26-11	4-47
3-A3-47	4-47
3-A3-56	4-47
3-A3-62	4-47
3-A3-80	4-40
3-A3-83	4-40
3-A5-7A	4-47
3-A5-7B	4-47
3-A5-8	4-47
3-A66-43	4-45
3M-01397	14-10
3M-01407	14-10
3M-01408	14-10
3M-01437	14-10
3M-01914	14-10
3M-01915	14-10
3M-01987	14-10
3M-01988	14-10
3M-01989	14-10

3M-01990	14-10
3M-05006	14-10
3M-05010	14-10
3M-05022	14-10
3M-05026	14-10
3M-05030	14-10
3M-05050	14-10
3M-05150	14-10
3M-05152	14-10
3M-05158	14-10
3M-05169	14-10
3M-05539	14-10
3M-05540	14-10
3M-05541	14-10
3M-05913	15-8
3M-06133	15-7
3M-06334	15-7
3M-06340	15-7
3M-06380	15-7
3M-06382	15-7
3M-06969	15-7
3M-06975	15-7
3M-06997	15-7
3M-07447	14-11
3M-07450	14-11
3M-07466	14-11
3M-07480	14-11
3M-07481	14-11
3M-07485	14-11
3M-07486	14-11
3M-07492	14-11
3M-07524	14-10
3M-08001	15-9
3M-08008	15-9
3M-08031	15-9
3M-08051	15-9
3M-08054	15-9
3M-08090	15-9
3M-08193	15-8
3M-08217	15-8
3M-08270	15-8
3M-08271	15-8
3M-08272	15-8
3M-08273	15-8
3M-08275	15-8
3M-08276	15-8
3M-08277	15-8
3M-08551	15-8
3M-08578	15-8
3M-08609	15-9

3M-08634	15-8
3M-08751	15-7
3M-08864	15-8
3M-08881	15-8
3M-08908	15-7
3M-08964	15-8
3M-26334	15-7
3M-26340	15-7
3M-49656	15-7
3M-980-KIT48	12-14
3M-980-KIT53	12-14
3M-983-02	12-14
3M-983-02-KC	12-14
3M-985-05	12-14
4-10-55	5-31
4-A1-223	5-23
4-A1-224L	5-23
4-A1-224R	5-23
4-A1-264	5-27
4-A23-7	5-35
4-A8-9	5-27
4-A8-9-1	5-27
50-109-13-1	15-3
50-14-125	6-4
50-14-125	9-14
50-14-27	9-14
50-14-39	9-14
50-18M-19	11-4
50-18M-20	11-4
50-18M-21	11-4
50-18M-21-PK	11-4
50-18M-22	11-4
50-18M-23	11-4
50-18M-23-PK	11-4
50-18M-25	11-4
50-18M-45	11-4
50-18P-10	11-3
50-18P-10-PK	11-3
50-18P-12	11-3
50-18P-19	11-3
50-18P-20	11-3
50-18P-21	11-3
50-18P-21-PK	11-3
50-18P-22	11-3
50-18P-23	8-20/11-3
50-18P-23-PK	11-3
50-18P-25	11-3
50-18P-25-PK	11-3
50-18P-5	11-3
50-18P-8	11-3

50-18P-8-PK	11-3
50-18P-9	11-3
50-18T-47C	11-4
50-18U-3S	11-3
50-18Z-260	11-3
50-18Z-260-PK	11-3
50-18Z-261	11-3
50-18Z-261-PK	11-3
50-18Z-487	11-2
50-18Z-507-10	11-4
50-18Z-507-12	11-4
50-18Z-507-12-PK	11-4
50-18Z-507-14	11-4
50-18Z-507-14-PK	11-4
50-18Z-515	11-1
50-18Z-516	11-1
50-18Z-548	11-1
50-18Z-549	11-1
50-18Z-552	11-1
50-18Z-553	11-1
50-19X-163P-32	11-4
50-19X-163P-40	11-4
50-19X-163P-48	11-4
50-19X-186P-10	4-42
50-19X-226	11-4
50-19X-227	11-4
50-19X-228	11-4
50-19X-231	11-4
50-19X-232	11-4
50-24J-3	1-18
50-26B-27	9-8
50-33A-10	2-9
50-33A-25	2-8
50-33A-26	2-8
50-33A-29	2-8
50-33A-30	2-8
50-33A-9	2-9
50-34A-1	2-9
50-34A-2	2-9
50-34B-1	2-9
50-34B-17	2-9
50-34B-18	2-9
50-34B-2	2-9
50-34C-1	2-9
50-34C-19	2-9
50-34C-2	2-9
50-3C-14	8-25
50-57-6C	7-63
50-58-15	2-13
50-58-25	2-13

50-58-5	2-13
50-58-6	2-13
50-71-105B	15-3
50-71-23	15-3
50-71-83-3-15	15-3
50-79-9	12-15
50-8-11	3-5
508-11-25	7-56
50-8-12	3-5
508-15-216-22	7-8
50-8-16	3-5
508-20-29-31	7-8
50-8-24	3-5
50-A91-6	7-63
50-A91-8	7-63
50-B18K-2C	11-1
50-B18K-3C	11-1
50-B18K-40	11-1
50-B18K-45	11-1
50-B18K-4C	11-1
50-B18P-24C	11-1
50-B18P-26C	11-1
50-B18P-74C	11-1
50-B18P-76C	11-1
50-B18P-78C	11-1
50-B18Q-19	11-1
50-B18Q-7	11-1
50-B9A-84	3-10
50-C18J-3	11-5
50-D18A-1	11-5
50-D18A-10	11-5
50-D18A-19	11-5
50-D18A-2	11-5
50-D18A-20	11-5
50-D18A-34	11-5
50-D18A-36	11-5
511-1-109-2	7-1
511-1-109-2-1	7-1
511-1-109-2-2	7-1
511-1-130A	7-1
511-1-130B	7-1
511-1-137L-B-A	7-2
511-1-137L-B-B	7-2
511-1-137R-B-A	7-2
511-1-137R-B-B	7-2
511-16-566-1166	7-12
511-20-882A-0-F3-V	7-30
511-23-183-0-108	7-12
512-1-189A-0-1	7-57
512-1-221B-4-G-K	7-57

# Index by Part Number



512-A1-115-1-0-2	7-57
512-A1-131B-1	7-57
512-A1-144B-1	7-57
512-A8-156B	7-59
512-A8-172B-1	7-59
512-A8-173B-1-1	7-59
512-A8-189B-1	7-59
513-5-600-1166-E-12	7-21
513-5-600-1250-A-12	7-22
513-5-686-1226-A	7-22
514-3-140	7-38
514-3-140-0-99	7-38
514-3-143	7-38
514-3-143-0-99	7-38
514-3-145A-2	7-36
514-3-152B	7-36
514-5-191-102	7-40
514-5-191-102B	7-40
515-10-55	8-5
515-10-61A	8-6
515-10-65	8-6
515-10-73A	8-6
515-10-75	8-5
515-10-78-1	8-5
515-10-78-2	8-5
515-10-78-3	8-5
515-11-29	8-18
515-11-29S	8-18
515-11-32	8-18
515-11-37	8-18
515-11-37-2	8-18
515-12-12-NS	8-19
515-12-13	8-19
515-12-23	8-19
515-14-113	8-31
515-16-45	8-28
515-9-61	8-20
515-9-70	8-20
515-9-71	8-20
515-9-78A	8-21
515-9-78B	8-21
515-9-81	8-21
515-A10-13	8-5
515-A9-53	8-20
516-24-11	8-32/33/34
516-24-12	8-38
516-2-46-1	8-32/33/34
516-2-47	8-38
516-25-5	8-32/33/34
516-25-6	8-37/38

519-1-1724-1196-4	7-8
519-3-418-0-FO	7-58
520-0-57	7-62
520-0-58	7-62
520-0-58A	7-62
520-0-59	7-62
520-0-72	7-62
520-0-72A	7-62
520-0-78Z	7-62
520-0-79	7-62
520-0-81Z	7-62
520-A11-7	7-62
522-2-1	7-63
522-23-7	8-21
522-5-216	12-4
522-5-234L-1	12-4
522-5-234R-1	12-4
523-6-722B-24	7-56
523-7-4	13-10
532-1-40	8-24/25
532-1-43	8-32/33/34
532-1-46	8-22/23
532-1-47	8-38
532-1-48	8-37/38
532-16-13	8-32/33/34
532-18-12	8-23
532-18-5A	8-24/25
532-5-22	8-24/25
532-5-40	8-32/33/34
532-5-42	8-22/23
532-5-43	8-22/23
532-6-21	8-25
532-6-24-1	8-32/33/34
532-6-25	8-23/24
532-6-26	8-23/24
532-6-27	8-23/24
532-6-28	8-23/24
532-6-29	8-37/38
532-6-30	8-22
532-6-31	8-22
532-6-32	8-22
532-6-33	8-22
532-9-41	8-24/25
532-9-52	8-22/23
532-9-52-1	8-22/23
532-9-54	8-22/23
532-9-54-1	8-22/23
532-A2-14A	8-24/25
532-A2-20L	8-32/33/34
532-A2-20R	8-32/33/34

532-A2-21	8-22/23
599-17-17C	3-8
599-512-7P	7-58
6001-A3-101B	7-48
6090-4-1037-625	7-18
6512-1-113B-4-3-L	7-57
6512-A3-12L-1206-431	7-58
6512-A3-13R-1206431A	7-58
6512-A3-4-1226-1-0-1	7-58
6512-A8-113B-1-1-K-B	7-59
6512-A8-117B-3KD-SP	7-59
6513-5-108-1176-A-12	7-22
6513-5-130-12	7-22
6513-5-151-1216	7-22
6513-5-152-1216	7-22
6514-9-100	7-15
6514-9-100-0-72	7-15
6515-11-100	8-18
6519-1-100-1166	7-8
7/8FRPX24	7-31
700-101-88	1-22
700-101-89	1-22
700-101-90	1-22
700-1-1045	4-43
700-1-27	13-9
700-1-28	13-10
700-14-3	12-15
700-1-44	13-9
700-14-5	12-15
700-1-48	13-9
700-1-58	13-10
700-16-1	6-3
700-1-62	7-49
700-1-63	13-9
700-1-66	7-49
700-1-67	13-11
700-1-68	13-8
700-17-101	9-2
700-17-124	9-5
700-17-126	9-5
700-17-14	3-11
700-17-140	3-6
700-17-140B	3-6
700-17-140R	3-6
700-17-14KIT	3-11
700-17-150	3-10
700-17-157	9-1
700-17-16	3-10
700-17-163	3-3
700-17-164	3-7



# Index by Part Number **B**

700-17-165	3-7
700-17-17	3-3
700-17-171	3-7
700-17-172	3-7
700-17-173	3-7
700-17-174	3-7
700-17-177	3-8
700-17-179	3-9
700-17-187	3-4
700-17-188	3-2
700-17-19	9-1
700-17-215	3-8
700-17-22	9-1
700-17-236	1-8
700-17-237	1-8
700-17-238	1-8
700-17-239	1-8
700-17-242	1-8
700-17-243	1-8
700-17-244	1-8
700-17-245	1-8
700-17-246	1-10
700-17-247	1-10
700-17-25	3-11
700-17-26	9-2
700-17-291	3-7
700-17-296	3-6
700-17-297	3-6
700-17-301	3-4
700-17-302	3-4
700-17-315	3-8
700-17-332	1-10
700-17-333	1-10
700-17-35	9-5
700-17-356	3-8
700-17-357	3-2
700-17-358	3-8
700-17-359	3-2
700-17-360	3-2
700-17-370	3-8
700-17-378	3-8
700-17-382-1	3-5
700-17-382-10	3-5
700-17-382-11	3-5
700-17-382-12	3-5
700-17-382-13	3-5
700-17-382-14	3-5
700-17-382-15	3-5
700-17-382-16	3-5
700-17-382-17	3-5

700-17-382-2	3-5
700-17-382-3	3-5
700-17-382-4	3-5
700-17-382-5	3-5
700-17-382-6	3-5
700-17-382-7	3-5
700-17-382-9	3-5
700-17-383	3-5
700-17-390	3-11
700-17-391	3-1
700-17-392	3-24
700-17-394	3-7
700-17-395	3-7
700-17-397	3-6
700-17-398	3-6
700-17-400	3-2
700-17-402	3-3
700-17-404	3-4
700-17-405	3-3
700-17-406	3-3
700-17-407	3-9
700-17-408	3-7
700-17-409	3-9
700-17-411	3-26
700-17-412	3-26
700-17-413	3-26
700-17-418	3-7
700-17-419	3-7
700-17-420	3-9
700-17-421	3-9
700-17-422	3-7
700-17-429	3-7
700-17-430	3-3
700-17-431	3-2
700-17-432	3-2
700-17-435	3-3
700-17-436	3-7
700-17-438	3-9
700-17-439	3-9
700-17-440	3-9
700-17-441	3-26
700-17-449	3-9
700-17-45	3-10
700-17-451	3-1
700-17-452	3-1
700-17-453	3-9
700-17-454	3-7
700-17-455	3-7
700-17-457	3-8
700-17-458	3-6

700-17-461	3-6
700-17-490	9-14
700-17-5	3-3
700-17-58	9-6
700-17-6	3-3
700-17-7	3-10
700-17-72	9-3
700-17-73	9-1
700-17-74	9-8
700-17-74-500	9-8
700-17-75	3-3
700-17-76	3-10
700-2-1	6-2
700-2-2	6-2
700-2-4	6-2
700-2-8	6-1
700-2-8-1	6-1
700-29-01	12-14
700-29-02	12-14
700-29-03	12-14
700-29-04	12-14
700-29-05	12-14
700-29-06	12-14
700-29-07	12-14
700-29-08	12-14
700-29-09	12-14
700-29-416	9-8
700-29-417	9-8
700-29-418	9-8
700-29-419	9-8
700-29-420	9-8
700-29-421	9-8
700-29-422	9-8
700-29-465	9-7
700-29-466	9-7
700-29-467	9-7
700-29-470	9-7
700-29-471	9-7
700-29-474	9-7
700-29-476	9-7
700-29-478	9-5
700-29-479	9-2
700-29-480	3-1
700-29-481	3-1
700-29-483	9-7
700-29-485-100	9-8
700-29-485-500	9-8
700-29-486-100	9-8
700-29-486-500	9-8
700-29-487-100	9-8

# Index by Part Number



700-29-488	9-1
700-29-489	9-4
700-29-491	3-6
700-29-492	10-11
700-29-493	10-11
700-29-494	10-11
700-29-496	9-7
700-29-497-100	9-8
700-29-498	9-7
700-29-KIT48	12-14
700-29-KIT53	12-14
700-3-1	4-40
700-3-10	4-41
700-3-102	4-36
700-3-105	4-59
700-3-106	4-36
700-3-107	4-56
700-3-108	4-59
700-3-109	4-59
700-3-11	4-41
700-3-111	4-59
700-3-114	4-49
700-3-115	4-55
700-3-12	4-41
700-3-13	4-41
700-3-14	4-41
700-3-16	4-41
700-3-19	4-49
700-3-2	4-55
700-3-23	4-59
700-3-24	4-59
700-3-25	4-59
700-3-26	4-59
700-3-27	4-59
700-3-28	4-59
700-3-29	4-59
700-3-3	4-49
700-3-30	4-56
700-3-31	4-60
700-3-32	4-49
700-3-33	4-49
700-3-35	4-49
700-3-36	4-48
700-3-38	4-59
700-3-4	4-40
700-3-40	4-48
700-3-41	4-48
700-3-42	4-48
700-3-43	4-48
700-3-44	4-48

700-3-45	4-48
700-3-46	4-48
700-3-48	4-49
700-3-49	4-48
700-3-50	4-59
700-3-6	4-40
700-3-60	4-50
700-3-7	4-40
700-3-70	4-45
700-3-72	4-48
700-3-73	4-49
700-3-74	4-56
700-3-75	4-36
700-3-76	4-36
700-3-77	4-37
700-3-8	4-40
700-3-80	4-59
700-3-81	4-59
700-3-82	4-59
700-3-86	4-59
700-3-87	4-42/44
700-3-88	4-59
700-3-89	4-56
700-3-9	4-40
700-3-90	4-56
700-3-94	7-63
700-3-95	7-63
700-3-96	7-63
700-3-97	7-63
700-3-98	7-63
700-4-101	5-31
700-4-109	5-32
700-4-110	5-32
700-4-111	5-32
700-4-112	5-32
700-4-113	5-32
700-4-116	5-32
700-4-133	5-28
700-4-134	5-28
700-4-135	5-28
700-4-136	5-34
700-4-137	5-34
700-4-138	5-34
700-4-139	5-34
700-4-140	5-34
700-4-141	5-34
700-4-142	5-34
700-4-173	5-34
700-4-2	5-31
700-4-316	5-31

700-4-340	5-31
700-4-39	5-29
700-4-406	5-32
700-4-407	5-29
700-4-408	5-29
700-4-409	5-31
700-4-420L	5-24
700-4-420R	5-24
700-4-421L	5-25
700-4-421R	5-25
700-4-422L	5-25
700-4-422R	5-25
700-4-424	5-31
700-4-434	5-33
700-4-441	5-34
700-4-450	5-30
700-4-451	5-30
700-4-452	5-30
700-4-457	5-27
700-4-474	5-31
700-4-481	5-26
700-4-501L	5-26
700-4-501R	5-26
700-4-502L	5-24
700-4-502R	5-24
700-4-503	5-27
700-4-92	5-29
700-4-93	5-29
700-4-96	5-29
700-4-97	5-35
700-50-15	17-1
700-50-16	7-49
700-50-18	1-22
700-50-19	11-2
700-50-20	11-2
700-50-21	11-2
700-50-22	11-2
700-50-23	11-2
700-50-24	11-2
700-50-28	11-2
700-50-29	11-2
700-50-30	11-2
700-50-31	11-2
700-50-34	2-14
700-50-35	5-35
700-50-37	11-3
700-50-39	11-3
700-50-40	11-3
700-50-41	8-60
700-50-44	11-2

700-50-49	11-2
700-50-50	11-5
700-50-51	11-5
700-50-52	11-5
700-50-53	11-5
700-50-55	9-14
700-50-56	11-3
700-50-56-PK	11-3
700-50-57	11-3
700-50-57-PK	11-3
700-50-58	11-3
700-50-58-PK	11-3
700-50-59	7-49
700-50-6	8-60
700-50-60	11-3
700-50-61	11-4
700-50-7	8-60
700-511-25	7-30
700-512-11	8-61
700-512-12-1-G	7-58
700-512-15	8-61
700-512-17	7-57
700-512-18-G	7-58
700-512-2	7-57
700-512-5A	7-58
700-512-9P	7-58
700-513-10	7-30
700-513-18-26	7-26
700-513-27-26	7-26
700-513-29	7-31
700-513-30-PPW	7-31
700-513-36	7-31
700-513-39	7-31
700-514-1	7-39
700-514-31	7-40
700-514-32	7-40
700-514-5	7-39
700-515-100	8-1
700-515-102	8-1
700-515-103	8-1
700-515-104	8-1
700-515-105	8-21
700-515-106	8-1
700-515-107	8-19
700-515-108	8-19
700-515-109	8-21
700-515-11	8-13
700-515-110	8-1
700-515-1-108-36	8-33
700-515-112	8-17

700-515-113	8-19
700-515-116	8-14
700-515-117	8-6
700-515-118	8-15
700-515-119	8-17
700-515-12	8-11
700-515-120	8-8
700-515-122	8-7
700-515-124	8-14
700-515-127	8-18
700-515-128	8-8
700-515-129	8-10
700-515-130	8-10
700-515-131	8-11
700-515-132	8-12
700-515-133	8-14
700-515-134	8-15
700-515-135	8-16
700-515-137	8-9
700-515-138	8-18
700-515-141	8-20
700-515-142	8-1
700-515-143	8-16
700-515-144	8-17
700-515-145	8-11
700-515-148	8-12
700-515-149	8-18
700-515-15	8-9
700-515-152	8-12
700-515-153	8-12
700-515-154	8-4
700-515-156	8-59
700-515-157	8-59
700-515-158	8-59
700-515-159	8-59
700-515-16	8-9
700-515-160	8-59
700-515-162	8-20
700-515-17	8-47
700-515-18	8-47
700-515-19	8-47
700-515-20	8-47
700-515-21	8-47
700-515-22	8-47
700-515-23	8-59
700-515-24	8-59
700-515-25	8-59
700-515-26	8-59
700-515-27	8-59
700-515-28	8-59

700-515-29	8-59
700-515-30	8-59
700-515-33	8-20
700-515-34	8-47
700-515-4-108-36	8-32
700-515-42	8-18
700-515-43	8-9
700-515-45	8-8
700-515-4-96-36	8-32
700-515-5	8-15
700-515-6	8-16
700-515-65	8-16
700-515-66	8-10
700-515-67	8-10
700-515-69	8-1
700-515-7	8-15
700-515-70	8-1
700-515-71	8-1
700-515-72	8-1
700-515-75	8-1
700-515-76	8-1
700-515-79	8-1
700-515-8	8-9
700-515-82	8-47
700-515-83	8-8
700-515-84	8-19
700-515-85	8-18
700-515-86	8-21
700-515-87	8-21
700-515-88	8-13
700-515-89	8-1
700-515-9	8-9
700-515-90	8-1
700-515-92	8-1
700-515-96	8-1
700-515-97	8-1
700-515-99	8-1
700-516-13	8-35
700-516-1-36	8-33
700-516-2	8-33
700-516-4-108	8-32
700-516-4-96	8-32
700-516-6-108-36	8-32
700-516-6-96-36	8-32
700-519-1	7-8
700-519-10	7-32
700-519-6	7-32
700-519-8	7-51
700-519-9	7-32
700-520-10	7-62



# Index by Part Number



700-520-12	7-62
700-520-13	7-62
700-520-14	7-62
700-520-15	7-62
700-520-16	7-62
700-520-17	7-62
700-520-18	7-62
700-520-19	7-62
700-520-7	7-62
700-522-12	12-4
700-522-13	12-4
700-522-14	12-3
700-522-15	12-4
700-522-19	12-4
700-522-23	12-4
700-522-27-A	12-1
700-522-27-B	12-1
700-522-27-C	12-1
700-522-28	12-4
700-522-2-B	12-1
700-522-31	12-3
700-522-32-A	12-1
700-522-32-B	12-1
700-522-32-C	12-1
700-522-33-B	12-1
700-522-33-C	12-1
700-522-34-B	12-1
700-522-36-B	12-1
700-522-36-C	12-1
700-522-37-B	12-1
700-522-37-C	12-1
700-522-3-B	12-1
700-522-3-C	12-1
700-522-42-B	12-1
700-522-42-C	12-1
700-522-43-B	12-1
700-522-43-C	12-1
700-522-4-A	12-1
700-522-4-B	12-1
700-522-4-C	12-1
700-522-7-A	12-1
700-522-7-B	12-1
700-522-7-C	12-1
700-523-18	13-10
700-523-19	7-34
700-523-19R	7-34
700-523-20	7-34
700-523-20-28	7-34
700-523-20-8	7-34
700-523-20R	7-34

700-523-22R	7-34
700-523-23R	7-34
700-523-24	7-35
700-523-26	7-35
700-523-27	7-35
700-523-7	13-10
700-523-8	7-35
700-532-13	8-22
700-532-14L	8-22
700-532-14R	8-22
700-532-15	8-22/23
700-532-4	8-20
700-532-5	8-20
700-532-6	8-34
700-532-7	8-20
700-532-8	8-23
700-532-9	8-22 thru 26
700-60-12	1-2
700-60-12-1	1-2
700-60-28	1-2
700-60-28-1	1-2
700-60-29	1-2
700-60-29-1	1-2
700-60-30	1-2
700-60-30-1	1-2
700-7-11	1-18
700-7-12	1-18
700-7-121	1-14
700-7-13	1-18
700-7-14	1-18
700-7-141	1-7
700-7-142	1-7
700-7-144	1-14
700-7-147	1-7
700-7-149	4-38/46
700-7-15	1-18
700-7-155	4-45
700-7-169	1-11
700-7-174	1-14
700-7-175	1-8
700-7-176	1-8
700-7-178	1-14
700-7-187	1-8
700-7-188	1-8
700-7-19	1-7
700-7-205	1-13
700-7-206	1-7
700-7-21	1-7
700-7-219	1-13
700-7-22	1-7

700-7-226	2-9
700-7-227	1-13
700-7-228	1-17
700-7-229L	1-17
700-7-229R	1-17
700-7-23	1-6
700-7-230	4-38/46
700-7-232	2-8
700-7-235	1-4
700-7-237	1-6
700-7-238	1-5
700-7-239	1-4
700-7-245	1-11
700-7-248	1-11
700-7-249	1-11
700-7-257	1-4
700-7-258	1-5
700-7-259	1-5
700-7-262	1-4
700-7-263	1-4
700-7-267	2-8
700-7-269	2-8
700-7-271	2-8
700-7-272	1-9
700-7-273	1-9
700-7-274	1-9
700-7-275	1-9
700-7-278	2-8
700-7-279	2-8
700-7-28	1-7
700-7-280	2-8
700-7-281	2-8
700-7-282	1-10
700-7-283	1-10
700-7-285	3-8
700-7-286	1-11
700-7-289	1-10
700-7-29	1-7
700-7-290	1-10
700-7-291	1-10
700-7-292	1-10
700-7-293	1-10
700-7-294	1-10
700-7-295	1-9
700-7-296	1-9
700-7-297	1-9
700-7-298	1-9
700-7-299	1-9
700-7-30	1-8
700-7-300	1-9



# Index by Part Number **B**

700-7-303	1-12
700-7-304	1-5
700-7-305	1-5
700-7-306	1-6
700-7-307	1-6
700-7-31	1-8
700-7-32	1-13
700-7-33	1-7/13
700-7-34	1-13
700-7-35	1-13
700-7-36	1-13
700-7-37	1-13
700-7-38	1-14
700-7-39	1-14
700-7-40	1-14
700-7-41	1-14
700-7-44	4-47
700-7-61	1-13
700-7-62	1-13
700-7-64	1-13
700-7-65	1-13
700-7-67	1-13
700-7-68	1-13
700-7-7	1-11
700-7-72	1-14
700-7-73	1-14
700-7-75	3-8
700-7-77	2-8
700-7-78	2-9
700-7-79	2-8
700-7-8	1-11
700-7-80	2-9
700-7-83	4-49
700-7-85	4-48
700-7-9	1-11
700-7-94	1-14
700-7-96	1-14
700-8-35	1-22
700-8-5	1-22
700-8-6	1-22
700-8-7	1-22
700-90-124	7-12
700-90-141-0-168	8-4
700-90-24	7-47
700-90-41-0-168	8-3
700-90-42-0-122	8-3
700-90-43	8-3
700-90-44	8-3
700-90-46-0-120	8-2
700-90-47-0-168	8-2

700-90-48	7-35
700-90-48-624	7-35
700-90-69-0-168	8-2
700-90-87	8-3
700-99-1	17-1
700-99-103	12-15
700-99-108	17-7
700-99-125	17-2
700-99-128	15-3
700-99-129	16-4
700-99-130	16-4
700-99-132	15-1
700-99-133	15-1
700-99-140	7-49
700-99-140	15-3
700-99-141	12-15
700-99-14-100	6-2
700-99-14-101	6-2
700-99-14-105	6-2
700-99-14-107	6-2
700-99-14-111	6-2
700-99-14-123	6-2
700-99-14-124	6-2
700-99-14-155	6-2
700-99-15	12-15
700-99-150	15-4
700-99-151	17-7
700-99-151B	17-7
700-99-152	17-7
700-99-164	14-11
700-99-165	14-11
700-99-167	12-5
700-99-168	16-4
700-99-169	16-4
700-99-186	15-3
700-99-193	15-3
700-99-194	12-6
700-99-195	12-6
700-99-196	12-6
700-99-201	15-4
700-99-202	16-4
700-99-202CA	16-4
700-99-203	16-1
700-99-206	6-2
700-99-216	12-8
700-99-217	12-8
700-99-218	12-9
700-99-219	12-9
700-99-220	12-9
700-99-221	12-8

700-99-222	12-8
700-99-223	12-9
700-99-224	12-9
700-99-225	12-9
700-99-227	12-9
700-99-228	12-9
700-99-232	7-63
700-99-24	14-11
700-99-242	12-9
700-99-245	12-9
700-99-246	12-9
700-99-248	12-8
700-99-249	12-8
700-99-250	12-8
700-99-251	12-8
700-99-252	12-8
700-99-254	17-2
700-99-258	12-15
700-99-259	12-15
700-99-260	15-4
700-99-262	12-11
700-99-263	12-11
700-99-264	12-11
700-99-266	9-14
700-99-267	9-14
700-99-268	9-14
700-99-269	9-14
700-99-270	9-14
700-99-271	9-14
700-99-281	12-11
700-99-283	7-49
700-99-283	15-3
700-99-304	6-4
700-99-306	16-4
700-99-307	16-4
700-99-308	16-4
700-99-309	16-4
700-99-310	16-4
700-99-312	16-4
700-99-313	16-4
700-99-314	16-4
700-99-319	15-4
700-99-319-53	15-4
700-99-322	16-5
700-99-323	16-5
700-99-324	16-5
700-99-328	16-5
700-99-329	16-5
700-99-330	16-5
700-99-331	16-1

# Index by Part Number



700-99-333	15-1
700-99-339	15-4
700-99-340	15-4
700-99-341	15-4
700-99-342	15-4
700-99-343-BULK	15-3
700-99-347	17-3
700-99-348	17-3
700-99-350	17-3
700-99-354	17-3
700-99-357	17-3
700-99-358	17-3
700-99-362	6-2
700-99-373	15-4
700-99-374	15-4
700-99-38	16-4
700-99-380	17-1
700-99-387	16-1
700-99-388	16-1
700-99-389	16-1
700-99-39	16-4
700-99-4	8-59
700-99-40	8-59
700-99-401	15-3
700-99-409	9-14
700-99-41	16-4
700-99-410	9-14
700-99-411	9-14
700-99-412	9-14
700-99-413	9-14
700-99-415	15-1
700-99-416	15-1
700-99-417	15-1
700-99-419	15-1
700-99-42	16-4
700-99-425-105	16-3
700-99-425-12	16-3
700-99-425-205	16-3
700-99-425-22	16-3
700-99-425-605	16-3
700-99-43	16-4
700-99-44	16-4
700-99-447	12-5
700-99-448	17-2
700-99-45	16-4
700-99-450	17-2
700-99-451	17-1
700-99-452	17-1
700-99-459	12-15
700-99-460	12-15

700-99-461	12-15
700-99-462	12-15
700-99-479	16-1
700-99-483	15-2
700-99-484	12-7
700-99-492-1GAL	16-3
700-99-492-55GAL	16-3
700-99-497	12-10
700-99-499	2-13
700-99-5	8-47
700-99-500	12-11
700-99-501	12-11
700-99-502-9V-1PK	9-15
700-99-502-AA-4PK	9-15
700-99-502-AAA-4PK	9-15
700-99-502-C-2PK	9-15
700-99-502-D-2PK	9-15
700-99-504	12-11
700-99-505	12-11
700-99-511	12-15
700-99-515	15-1
700-99-521	12-15
700-99-55	17-7
700-99-56	17-7
700-99-57	17-7
700-99-6	15-2
700-99-65	13-9
700-99-65-21R	13-9
700-99-66	13-9
700-99-66-31R	13-9
700-99-67	13-9
700-99-67-41R	13-9
700-99-68	16-4
700-99-69	13-9
700-99-69-9R	13-9
700-99-7	15-2
700-99-70	13-9
700-99-70-15R	13-9
700-99-71	12-7
700-99-8	15-2
7-13-35	3-8
7-5-107	1-9
7-5-108	1-9
7-5-111	1-9
7-5-112	1-9
7-5-113	1-9
7-5-114	1-9
7511-A1-05	7-4
7511-A1-06L	7-4
7511-A1-06R	7-4

7-A2-51	1-17
7-A3-127	1-3
7-A3-128	1-3
7-A3-132	1-3
8-15-4	2-10
8-16-3	2-10
8-5-30	2-7
8-5-33	2-7
8-5-34	2-7
8-5-38	2-7
8-5-38HD	2-7
8-5-41	2-7
8-5-42	2-7
8-5-48	2-7
8-5-49	2-7
8-5-53	2-7
8-5-54	2-7
8-5-56	2-7
8-5-58	2-7
8-5-59	2-7
8-5-61	2-7
8-6-85	1-22
8-8-17	2-10
8-8-20	2-10
8-8-3	2-10
8-8-6	2-10
8-9-7	2-10
8-9-8	2-10
9001-0-1441	4-42
9001-0-1441-1	4-42
9011-1-530	7-60
9011-1-530G	7-60
9017-8-13	3-9
9029-A4-359-2	7-61
9029-A4-359-2-6	7-61
9029-A4-361-2	7-61
9029-A4-361-2-6	7-61
90-4-1049-0-120	8-2
90-4-1076-613	7-17
90-4-1081-0-108	7-23
90-4-1082-0-115	7-21
90-4-1092-552	7-50
90-4-1109-0-130	8-33
90-4-1215-613	7-17
90-4-1227-553	7-18
90-4-1292-0-103	8-31
90-4-1390-0-108	7-33
90-4-1393-0-96	7-33
90-4-1398-0-102	7-47
90-4-1399-240	7-13

90-4-1399-625	7-13
90-4-1407-0-120	8-31
90-4-1563-0-126	7-40
90-4-1568-620	7-14
90-4-1571-613	7-14
90-4-1584-0-100	8-37
90-4-1585-0-100	8-37
90-4-1604-558	7-54
90-4-1605-558	7-54
90-4-1608-0-101	7-48
90-4-1635-0-160	8-31
90-4-1650-613	7-13
90-4-1666-0-112	7-31
90-4-1666-0-553	7-31
90-4-1689-108	7-15
90-4-1694-0-102	7-48
90-4-1706-618	7-52/55
90-4-1707-626	7-35
90-4-1714-0-109	7-36; 8-29/30
90-4-1718-0-99	7-36
90-4-1721-0-110	7-24
90-4-1726-0-160	8-29/30
90-4-1726-0-160	8-30
90-4-1727-0-104	8-30
90-4-1727-0-120	8-29
90-4-1728-0-108	8-29/30
90-4-1729-0-120	8-29/30
90-4-1729-0-50	8-29/30
90-4-1730-0-154	8-29/30
90-4-1745-618	7-52/55
90-4-1753-0-102	7-48
90-4-1760-0-85	8-37/38
90-4-1776-0-98	8-31
90-4-1782-0-100	8-36
90-4-1784-0-114	8-36
90-4-1785-0-114	8-36
90-4-1788-0-114	8-36
90-4-1801-0-100	7-36
90-4-1838-0-115	7-23
90-4-1852-0-100	7-36
90-4-1855-559	7-18
90-4-1857-0-165	8-2
90-4-1861-0-115	8-2
90-4-1867-0-1200	8-2
90-4-1876-562	7-35
90-4-1876-624	7-35
90-4-1892-0-115	7-23
90-4-1896-0-108	7-23
90-4-1900-0-112	8-31
90-4-1903-0-156	7-33

90-4-1904-0-96	7-56
90-4-1906-547	7-14
90-4-1911-0-123	7-21
90-4-1931-618	7-54
90-4-1936-0-112	8-31
90-4-1937-0-112	8-31
90-4-1938-0-112	8-31
90-4-1939-0-112	8-31
90-4-1962-0-120	8-2/27/28
90-4-1978-0-93	7-1
90-4-1983-618	7-63
90-4-1988P-0-112	7-21
90-4-1988P-0-135	7-21
90-4-1989-553	7-50
90-4-1992-624	7-13
90-4-1993-0-96	7-56
90-4-2028-0-102	7-48
90-4-2033P-0-112	7-21
90-4-2037-619	7-17
90-4-2058-618	7-52/53
90-4-2059-618	7-52/53
90-4-2079-619	7-18
90-4-2101-0-96	7-56
90-4-2105-606	7-54
90-4-2106-606	7-55
90-4-2107-0-16	7-23
90-4-2111-619	7-17
90-4-2119-0-16	7-60
90-4-2120-619	7-17
90-4-2129-0-114	8-27/28
90-4-2133-0-76	7-1
90-4-2136-627	7-50
90-4-2159-618	7-55
90-4-2173-0-115	7-23
90-4-2216-0-120	8-27/28
90-4-2225-0-165	8-27/28
90-4-2226-0-120	8-27/28
90-4-2236-0-114	8-27
90-4-2236-0-114	8-28
90-4-2238-0-114	8-27/28
90-4-2303-580	7-55
90-4-2305-240	7-13
90-4-2305-625	7-13
90-4-2306-0-48	7-55
90-4-2308-621	7-18
90-4-2309-561	7-56
90-4-2310-0-115	7-24
90-4-2313-0-73	7-2
90-4-2313-0-88	7-2
90-4-2314-613	7-14

90-4-2315-617	7-14
90-4-2317-0-115	7-23
90-4-2349-0-121	7-23
90-4-2352-240	7-17
90-4-2352-625	7-17
90-4-2352-96	7-17
90-4-2360-0-101	7-48
90-4-236-0-101	7-48
90-4-2365-613	7-13
90-4-2367-618	7-14
90-4-2381-0-112	7-22
90-4-2396-618	7-14
90-4-2400P-0-117	7-12
90-4-2406-621	7-35
90-4-2407-626	7-50
90-4-2412-0-113	7-23
90-4-2468-0-108	7-32
90-4-2471-0-113	7-32
90-4-2480-622	7-35
90-4-2494-0-108	7-32
90-4-2495-0-108	7-32
90-4-2503-625	7-13
90-4-2519-312	7-14
90-4-483-0-114	7-21
90-4-527-0-108	8-33
90-4-646-0-115	7-22
90-4-703-0-93	7-37
90-4-819-0-168	8-4
90-4-820-0-168	8-4
90-4-821-0-168	8-4
90-4-822-0-168	8-4
90-4-828-0-120	8-2/29/30/31
90-4-871-0-99	7-48
90-4-900-618	7-52/53
90-4-920-0-110	7-25
90-4-921-0-110	7-25
90-4-928-618	7-52/53
90-4-983-0-123	7-21
90-4-996-562	7-35
90-4-996-626	7-35
9050-57-1	7-63
9050-57-3	7-63
9511-16-262	9-5
9511-A1-24L	7-4
9511-A1-24R	7-4
9512-A1-135B-G	7-57
9512-A8-377B-1	7-59
9512-A8-417B-1GKD-SP	7-59
9513-1-1458A	7-8
9513-5-1114-1166-E12	7-21

# Index by Part Number



9514-3-11-2	7-36
9514-3-78B	7-36
9519-11-1558	7-35
9519-1-507-E9	7-8
9519-1-909	7-8
9532-A2-11	8-22
AC-27403	2-11
AC-27404N	2-11
AC-27404N-W	2-11
AC-27406-N	2-11
AC-27406-N-W	2-11
AC-275-5-1	2-12
AC-277-5-1	2-12
AC-28112	2-11
AC-28112-W	2-11
AC-28408-W	2-11
AC-28409-W	2-11
AC-30371-22.5	2-12
AC-30391N-22.5	2-12
AC-30391N-22.5-W	2-12
AC-30391N-24.5-W	2-12
AC-313-5-1	2-12
AC-31814-17.5	2-12
AC-31868-17.5	2-12
AC-32052-22.5	2-12
AC-5901	2-14
AC-5902	2-14
AC-5903	2-14
AL-000150	2-14
AL-000181	2-14
AL-000182	2-14
AL-883110	2-11
AL-883111	2-11
AL-883112	2-11
AL-883420	2-11
AL-883620	2-11
AL-883621	2-11
AL-883622	2-11
AL-983120	2-11
AL-983121	2-11
AL-983122	2-11
AL-983620	2-11
AL-983621	2-11
AL-983622	2-11
AN-49246-10-SP	13-7
AV-065437	3-32
AV-065439	3-32
AV-102626	3-32
AV-103010	3-32
AV-229859	3-32

AV-281865	3-32
AV-286171	3-32
AV-287114	3-32
AV-289714	3-32
AV-90054007	3-32
AV-90054079	3-32
AV-90054088	3-32
AV-90554241	3-32
AV-KN28060	3-32
AV-KN28510	3-32
AV-KN28520	3-32
AV-KN28600	3-32
AV-KN28601	3-32
BC-1701005	13-11
BC-1701015	13-11
BC-1702300	13-11
BC-1702303	13-11
BC-1702305	13-11
BC-1702310	13-11
BC-1702315	13-11
BC-1704300	13-11
BC-1704303	13-11
BC-1704305	13-11
BC-1704310	13-11
BE-A-23L	12-2
BE-A-23R	12-2
BE-A-25R/L	12-2
BE-A-29L	12-2
BE-A-29R	12-2
BE-A-33L	12-2
BE-A-33R	12-2
BE-A-35R/L	12-2
BE-B-1732	12-4
BE-B-21	12-2
BE-B-23S	12-2
BE-B-25S	12-2
BE-B-29S	12-2
BE-B-33S	12-2
BE-B-35S	12-2
BE-B-39S	12-2
BE-B-57NT	12-3
BE-B-57NT	12-3
BE-B-67NT	12-3
BE-B-711	12-4
BE-B-83HD	12-3
BE-B-84HD	12-3
BE-B-87	12-2
BE-K-1732	12-4
BK-4-A5-380S	5-1
BK-4-A5-381GB	5-1

BK-4-A5-382NGB	5-1
BK-700-4-179S	5-1
BK-700-4-180GB	5-1
BK-700-4-181NGB	5-1
BK-700-4-272S	5-3
BK-700-4-273GB	5-3
BK-700-4-274NGB	5-3
BK-700-4-342S	5-1
BK-700-4-343GB	5-1
BK-700-4-344NGB	5-1
BK-700-4-345S	5-3
BK-700-4-346GB	5-3
BK-700-4-347NGB	5-3
BK-700-4-349S	5-1
BK-700-4-350GB	5-1
BK-700-4-351NGB	5-1
BK-700-4-369S	5-3
BK-700-4-370GB	5-3
BK-700-4-371NGB	5-3
BK-700-4-413S	5-5
BK-700-4-414GB	5-5
BK-700-4-415NGB	5-5
BK-700-4-416S	5-1
BK-700-4-417GB	5-1
BK-700-4-418NGB	5-1
BK-700-4-425S	5-3
BK-700-4-426GB	5-3
BK-700-4-427NGB	5-3
BK-700-4-478S	5-5
BK-700-4-479GB	5-5
BK-700-4-480NGB	5-5
BK-700-4-485S	5-3
BK-700-4-486GB	5-3
BK-700-4-487NGB	5-3
BK-700-4-495S	5-5
BK-700-4-496GB	5-5
BK-700-4-497NGB	5-5
BK-AL24R8NH000NN007	4-22
BK-GP-052-11	5-6
BK-LG0048-01	5-4/33
BK-LG0068	5-33
BK-LG0083-01	5-2/4
BK-LG0085	5-2/4
BK-LG0094-6650	5-2/4
BK-LG0219-01	5-2/4
BK-LG0259	5-2
BK-LG0260	5-2
BK-LG0261-01	5-2/4
BK-LG0264	5-2
BK-LG0266	5-2/4

BK-LG0371-01	5-2
BK-LG0428	5-2/4
BK-LG0531-02	5-2
BK-LG0541-01	5-2/4
BK-LG0542-01	5-2/4
BK-LG0543-01	5-2/4
BK-LG0570-01	5-2/4
BK-LG0658-01	5-2/4
BK-LG0659-01	5-2/4
BK-LG0663	5-2/4
BK-LG0880	5-4
BK-LG0910	5-6
BK-LG0928	5-4
BK-LG0932	5-6
BK-LG0933-01	5-6
BK-LG0934	5-6
BK-LG0944-10	5-6
BK-LG1823-01	5-4
BK-LG1870	5-35
BK-LG2242-01	5-6
BK-PP0012-36	4-23/25
BK-PP0012-37	4-24
BK-PP0013-77	5-2/4
BK-PP0014-07	5-2/4
BK-PP0014-27	5-2/4
BK-PP0016-62	5-2/4
BK-PP0018-02	5-2/4
BK-PP0050-73	4-24
BK-PP0050-75	4-23/25
BK-PP0052-21	5-2/4/6
BK-SL0450	4-23
BK-SL0502-48	4-24
BK-SL0724-42	4-24
BK-SL0724-48	4-24
BK-SL0744-07	4-23
BK-SL0893	4-23
BK-SLOA1280-S8	4-22
BK-SP0099	4-25
BK-SP0100	4-24
BK-SP0110	4-24
BK-SP0120	4-24
BK-SP0123	4-25
BK-SP0131	4-24
BK-SP0142-01	4-25
BK-SP0142-02	4-25
BK-SP0142-03	4-25
BK-SP0143	4-25
BK-SP0149-04	4-25
BK-SP0149-05	4-25
BK-SP0160	4-24

BK-SP0161	4-24
BK-SP0162	4-24
BK-SP0178	4-25
BK-SP0202-01	4-23
BK-SP0202-10	4-23
BK-SP0224	4-23
BK-XB-BAL-023-07	5-2/4/6
BK-XB-LG0089	5-34
BK-XB-LG0219-02	5-2/4
BK-XB-SP0205-01	4-23
BK-XB-SPG020-18	4-23
BK-XB-SPG-020-36	5-2/4/6
BK-XB-SPN-053-60	4-23
BL-SL0853-40	4-24
BP-10-50046	5-8
BP-10-50053	5-8
BP-10-50058	5-8
BP-10-70020	5-8
BP-10-70501	5-8
BP-10-80126	5-8
BP-20-10501	5-8
BP-20-110101	5-8
BP-20-20503	5-8
BP-20-40500	5-8
BP-20-60001	5-8
BP-20-60500	5-8
BP-20-99029	5-8
BP-700-4-364S	5-7
BP-700-4-365GB	5-7
BP-700-4-366NGB	5-7
BP-SD-002	6-4
BP-SD-003	6-4
BP-ST-100	5-35
BU-2809001	2-2
BU-2819001	2-3
BU-4809002	2-2
BU-4809003	2-2
BU-4809004	2-2
BX-065104	3-23
BX-065174	1-16
BX-065176	1-16
BX-065437	3-23
BX-065439	3-23
BX-065476	3-23
BX-102626	3-23
BX-103010	3-23
BX-229859	3-22
BX-276566	3-23
BX-278614	3-22
BX-281865	3-23

BX-286171	3-22
BX-286500	3-22
BX-287114	3-23
BX-289714	3-23
BX-800064	3-22
BX-800372	3-22
BX-800636	3-23
BX-800737	3-23
BX-800831	3-7
CA-TM4515QSP	1-3
CB-22153	1-16
CB-41100	1-16
CB-41106	1-16
CB-42100	1-16
CB-42106	1-16
CB-43106	1-16
CL-100	17-7
CL-432224	17-6
CL-4324836	17-6
CL-43248HAS	17-6
CL-43380144H	17-6
CL-435724R1	17-6
CL-436524	17-6
CL-43681208X	17-6
CL-43681210X	17-6
CL-43685514	17-6
CL-437924R	17-6
CL-438224	17-6
CL-4385HPL	17-6
CL-43-87	17-6
CL-43887510	17-6
CL-4390160H	17-6
CL-439618	17-6
CL-485	17-7
CL-553	17-7
CL-70305	17-7
CM-62273	13-9
CM-62373	13-9
CM-638219	13-9
CM-638284	13-9
CM-639094	13-9
CO-105776	2-3
CP-711	14-1
CP-714	14-1
CP-715	14-1
CP-717	14-1
CP-721	14-2
CP-734H	14-2
CP-746	14-2
CP-772H	14-3

# Index by Part Number



CP-778	14-5
CP-785	14-4
CP-789HR	14-4
CP-789R-26	14-4
CP-797-6	14-3
CP-828	14-5
CP-860	14-4
CP-864	14-5
CP-869S	14-5
CP-A046050	14-8
CP-A046071	14-8
CP-A046073	14-8
CP-A046076	14-8
CP-A046078	14-8
CP-A046087	14-8
CP-A046088	14-8
CP-A046089	14-8
CP-A046090	14-8
CP-A046094	14-8
CP-A046096	14-8
CP-A047050	14-8
CP-A047051	14-8
CP-A047078	14-8
CP-A047095	14-8
CP-CA000046	14-8
CP-CA155312	14-8
CR-1343	1-22
CR-1643	1-22
CR-1644	1-22
CR-1743	1-22
CR-35066	1-21
CR-40136	1-21
CR-42623	1-21
CR-42627	1-21
CR-43764	1-21
CR-46300	1-21
CR-46305	1-21
CR-47692	1-21
CR-47697	1-21
CT-395-8149	11-2
CT-395-8152	11-2
CT-395-8155	11-2
CT-395-8166	11-2
CT-396-8002	11-2
CT-396-8003	11-2
CT-396-8006	11-2
DA-847	1-21
DA-849	1-21
DA-850	1-21
DA-851	1-21

DA-859	1-21
DA-861	1-21
DA-863	1-21
DA-D21AX50354	1-1
DA-D22AX503A1279	1-1
DA-D22AX503A624	1-1
DA-D22AX6031500	1-1
DA-D22AX603A1275	1-1
DA-D22AX603A1276	1-1
DA-M10KY105	1-12
DA-M10KY106	1-12
DA-M16KY202	1-12
DA-SR1JA	4-58
DA-SR1JA100	4-58
DA-SR1JA102	4-58
DA-SR1JA103	4-58
DA-SR1JA112	4-58
DB-705SP-1/4	14-9
DB-705SP-1/8	14-9
DB-705SP-10	14-9
DB-705SP-11/32	14-9
DB-705SP-11/64	14-9
DB-705SP-12	14-9
DB-705SP-17/64	14-9
DB-705SP-3/8	14-9
DB-705SP-5/16	14-9
DB-705SP-5/32	14-9
DB-705SP-7/16	14-9
DB-705SP-7/32	14-9
DB-705SP-9/32	14-9
DB-705SP-F	14-9
DB-EC1/4	14-9
DB-EC1/8	14-9
DB-EC11	14-9
DB-EC11/32	14-9
DB-EC11/64	14-9
DB-EC13/64	14-9
DB-EC17/64	14-9
DB-EC3/16	14-9
DB-EC3/8	14-9
DB-EC5/16	14-9
DB-EC5/32	14-9
DB-EC7/32	14-9
DB-EC9/32	14-9
DB-HQ1/16	14-9
DB-HQ1/2	14-9
DB-HQ1/4	14-9
DB-HQ1/8	14-9
DB-HQ10	14-9
DB-HQ11/32	14-9

DB-HQ11/64	14-9
DB-HQ13/32	14-9
DB-HQ13/64	14-9
DB-HQ15/32	14-9
DB-HQ15/64	14-9
DB-HQ17/64	14-9
DB-HQ19/64	14-9
DB-HQ21/64	14-9
DB-HQ23/64	14-9
DB-HQ25/64	14-9
DB-HQ27/64	14-9
DB-HQ29/64	14-9
DB-HQ3/16	14-9
DB-HQ3/32	14-9
DB-HQ3/8	14-9
DB-HQ31/64	14-9
DB-HQ5/16	14-9
DB-HQ5/32	14-9
DB-HQ5/64	14-9
DB-HQ7/16	14-9
DB-HQ7/32	14-9
DB-HQ7/64	14-9
DB-HQ9/32	14-9
DB-HQ9/64	14-9
DB-HQG	14-9
DO-DS01	8-2
DO-HG01	8-7
DO-HG02	8-7
DO-HG03	8-7
DO-HP01	8-19
DO-RB01	7-37
DO-RB02	7-37
DO-RP01	7-10
DO-RP02	7-10
DO-RP03	7-10
DO-RP04	7-10
DO-SP01	7-24
DO-SS01	7-27
DW-03-012480	2-7
DW-03-012582	2-5
DW-03-120574	2-7
DW-03-120754	2-6
DW-03-120877	2-5
DW-03-122126	2-7
DW-03-122222	2-7
DW-03-122550	2-6
DW-03-122607	2-5
DW-03-123207	2-5
DW-03-123365	2-5
DW-03-123396	2-6

DW-03-123397	2-6
DW-04-14059-001	2-4
DW-04-14344-004	2-3
DW-04-14935-001	2-4
DW-04-15501-001	2-3
DW-04-15571-001	2-3
DW-47-07791-013	2-1
DW-47-14018-007	2-1
DW-53-123537	2-5
DW-53-123564	2-5
DW-53-123566	2-5
DW-85-123207	2-5
EG-JBP-GEARKIT	5-34
FL-1580FB-KIT	12-5
FL-1580LM-KIT	12-5
FL-1585FB-KIT	12-5
FL-1590-12	12-5
FL-1590FB-KIT	12-5
FL-1600-11M	12-5
FL-1600-15M	12-5
FP-1020	14-1
FP-105	14-5
FP-3801A	14-6
FP-4050A	14-4
FP-610	14-1
FP-610K	14-1
FP-641	14-1
FP-660	14-1
FP-700	14-2
FP-700L	14-2
FP-730	14-5
FP-734TS	14-2
FP-734TSK	14-2
FP-739	14-2
FP-752K	14-4
FP-753	14-4
FP-775C	14-3
FP-775L	14-3
FP-777	14-3
FP-777L	14-3
FP-783	14-4
FP-784	14-4
FP-794L	14-3
FP-794LS	14-3
FP-795L	14-3
FP-891	14-6
FP-892	14-6
FP-894	14-6
FP-896	14-5
FP-982	14-7

FP-997K	14-7
FR-BR01-625	7-19
FR-BR03-624	7-18
FR-NR03	7-3
FR-NR04	7-3
FR-NR05	7-3
FR-RB01	7-37
FR-RB02	7-37
FR-RB03	7-37
FR-RB04	7-37
FR-RP03	7-9
FR-RP04	7-9
FR-RP05	7-9
FR-SP01	7-24
FR-SP02	7-24
FR-SP03	7-24
FR-SS01	7-28
FR-TR04-624	7-15
FS-6801	4-16
FS-6897	4-16
FS-6902	4-16
FS-6905	4-16
FS-6935	4-16
FS-6943	4-16
FS-6944	4-16
FS-7135	4-16
FS-7136	4-16
FS-7140	4-16
FS-7145	4-16
FS-7400	4-16
FS-7403	4-16
FS-7410	4-16
FS-7443	4-16
FS-7545	4-16
FS-7555	4-16
FS-7795	4-16
FS-7798	4-16
FS-7808	4-16
FS-7843	4-16
FS-7850	4-16
FS-8018	4-16
FS-8033	4-16
FS-8050	4-16
FS-8203	4-16
FS-8204	4-16
FS-8204	4-23
FS-8901	4-16
FS-9033	4-16
FS-9039	4-16
FS-9069	4-16

FS-9082	4-16
FS-9083	4-16
FS-9101	4-16
FS-9105	4-16
FS-9121	4-16
FS-9122	4-16
FS-9130	4-16
FS-9158	4-16
FS-9177	4-16
FS-9192	4-16
FS-9213	4-16
FS-9219	4-16
FS-9241	4-16
FS-9264	4-16
FS-9265	4-16
FS-9270	4-16
FS-9293	4-16
FS-9320	4-16
FS-9321	4-16
FS-9366	4-16
FS-9367	4-16
FS-9370	4-16
FS-9371	4-16
FS-9394	4-16
FS-9422	4-16
FS-9466	4-16
FS-9619	4-16
FS-9640	4-16
FS-9648	4-16
FS-9780	4-16
FS-9921	4-16
FS-9922	4-16
GB-646155	4-18
GB-83102	4-18
GB-83122	4-18
GB-83123	4-18
GB-83125	4-18
GB-83125	4-23
GB-83130	4-18
GB-83203	4-18
GB-83204	4-18
GB-83207	4-18
GB-83209	4-18
GB-83221	4-18
GB-83309	4-19
GB-85000	4-18
GB-85001	4-19
GB-85003	4-21
GB-85012	4-19
GB-85013	4-18



# Index by Part Number



GB-85023	4-19
GB-85026	4-20
GB-85030	4-18
GB-85033	4-20
GB-85036	4-18
GB-85046	4-19
GB-85047	4-19
GB-85061	4-21
GB-85300	4-19
GB-85302	4-19
GB-85310	4-18
GB-85311	4-20
GB-85316	4-20
GB-85319	4-20
GB-85320	4-19
GB-85724	4-21
GD-BR02-625	7-19
GD-BR03-626	7-19
GD-CM01	7-47
GD-DS01	8-2
GD-HG01	8-11
GD-NR03	7-3
GD-RB01	7-37
GD-RB02	7-38
GD-RP01	7-9
GD-RP02	7-9
GD-SP01	7-24
GD-SP02	7-24
GD-SS01	7-28
GD-SS02	7-28
GD-TR01-616	7-15
GD-TR03-626	7-15
GL-01	17-4
GL-02	17-4
GL-03	17-4
GL-04	17-4
GL-05	17-4
GL-06	17-5
GL-07L	17-5
GL-08L	17-5
GL-09L	17-5
GL-10L	17-5
GL-12	17-5
GL-13	17-5
GL-15L	17-5
GL-15L-PF	17-5
GL-15M	17-5
GL-15M-PF	17-5
GL-15XL	17-5
GL-15XL-PF	17-5

GL-16L	17-5
GL-16L-PF	17-5
GL-16M	17-5
GL-16M-PF	17-5
GL-16XL	17-5
GL-16XL-PF	17-5
GL-18L	17-5
GL-18XL	17-5
GR-43050	10-1
GR-43390	10-1
GR-43411	17-2
GR-43684	9-5
GR-43690	10-1
GR-44530	9-12
GR-44540	9-12
GR-44810	9-12
GR-45252	10-1
GR-45253	10-1
GR-45262	10-1
GR-45263	10-1
GR-45432	10-1
GR-45433	10-1
GR-45442	10-2
GR-45443	10-2
GR-45462	10-2
GR-45463	10-2
GR-45662	10-1
GR-45663	10-1
GR-46302	10-2
GR-46303	10-2
GR-46782	10-1
GR-46783	10-1
GR-46792	10-1
GR-46793	10-1
GR-46802	10-2
GR-46803	10-2
GR-46832	10-2
GR-46833	10-2
GR-46862	10-2
GR-46863	10-2
GR-46872	10-2
GR-46873	10-2
GR-46902	10-1
GR-46903	10-1
GR-46922	10-1
GR-48282	9-14
GR-50232	10-3
GR-50852	10-3
GR-50972	10-3
GR-50992	10-3

GR-52513	10-3
GR-52533	10-3
GR-52553	10-3
GR-52772	10-3
GR-52892	10-3
GR-52922	10-3
GR-53062	10-1
GR-53063	10-1
GR-53102	10-3
GR-53103	10-3
GR-53163	10-3
GR-60001	10-5
GR-60191	10-5
GR-60311	10-5
GR-60331	10-5
GR-66001	10-4
GR-66160	10-5
GR-66800	10-4
GR-66810	10-4
GR-66820	10-4
GR-66900	10-4
GR-66910	10-4
GR-66911	10-4
GR-66930	10-5
GR-67000	10-4
GR-67002	10-4
GR-67040	10-4
GR-67070	10-4
GR-67071	10-4
GR-87240	9-4
GR-90103	10-6
GR-90122	10-6
GR-90123	10-6
GR-90162	10-6
GR-90172	10-6
GR-90173	10-6
GR-91042	10-6
GR-91043	10-6
GR-91950	10-5
GR-91962	10-6
GR-91963	10-6
GT-1	8-48
GT-11	8-48
GT-12	8-48
GT-13	8-48
GT-14	8-48
GT-15	8-48
GT-16	8-48
GT-17	8-48
GT-18	8-48

GT-19	8-48
GT-2	8-48
GT-20	8-48
GT-21	8-48
GT-22	8-48
GT-23	8-48
GT-3	8-48
GT-4	8-48
GT-5	8-48
GT-6	8-48
GT-7	8-48
GT-8	8-48
GT-9	8-48
GT-90X100LTO	8-39
GT-90X90LTO	8-39
GT-98X100LTO	8-39
GT-98X105LTO	8-39
GT-BOT-1-11X98	8-41
GT-BOT-1-12X98	8-41
GT-BOT-1-15X90	8-41
GT-BOT-1-15X98	8-41
GT-INT-11X98	8-40
GT-INT-12X98	8-40
GT-INT-15X98	8-40
GU-AS1032	1-16
GU-AS1033	1-16
GU-AS1040	1-16
GU-AS1041	1-16
GU-AS1043	1-16
GU-AS1044	1-16
GU-AS3000	1-16
GW-1	8-60
GW-10	8-60
GW-11	8-60
GW-12	8-60
GW-13	8-60
GW-14	8-60
GW-2	8-60
GW-3	8-60
GW-4	8-60
GW-5	8-60
GW-6	8-60
GW-7	8-60
GW-8	8-60
GW-9	8-60
HA-400-10001	1-17
HA-400-10004	1-17
HA-400-10008	1-17
HA-400-10140	1-17
HA-400-10141	1-17

HA-400-10142	1-17
HA-400-10143	1-17
HA-400-10144	1-17
HA-400-10146	1-17
HA-400-10155	1-17
HA-400-10211	1-17
HA-400-10212	1-17
HA-400-10213	1-17
HA-400-10214	1-17
HA-400-10216	1-17
HA-400-10305	1-17
HA-400-20211	1-17
HA-400-20213	1-17
HA-400-20215	1-17
HA-427-10431	1-17
HA-427-10558	1-17
HA-427-10563	1-17
HL-700-4-378S	5-9
HL-700-4-379GB	5-9
HL-700-4-380NGB	5-9
HL-700-4-381S	5-9
HL-700-4-382GB	5-9
HL-700-4-383NGB	5-9
HL-700-4-384S	5-9
HL-700-4-385GB	5-9
HL-700-4-386NGB	5-9
HL-700-4-387S	5-9
HL-700-4-388GB	5-9
HL-700-4-389NGB	5-9
HL-DB-610-30	6-3
HL-JS-300-J	5-35
HL-PH200-1	6-3
HL-TF-0110	6-4
HL-XA-10198	6-3
HP-CC01	7-5
HP-CC02	7-5
HP-HG01	8-14
HP-RP01	7-10
HT-A-14187	3-29
HT-A-14566	3-29
HT-A-1968	3-29
HT-A-2552	3-29
HT-AK-147	3-28
HT-AK-152	3-28
HT-AK-162	3-28
HT-AK-53	3-28
HT-AK-54	3-28
HT-AKH-187-3	3-28
HT-AKHD-203-3	3-28
HT-AMBOX.24	4-14

HT-AMBOX.48	4-14
HT-AMBOX.81	4-14
HT-AMBOX.93	4-14
HT-B-21505	4-15
HT-B-23165	4-15
HT-B-25261	4-15
HT-C-20064-1	4-12
HT-C-20064-2	4-12
HT-C-23086-1	4-12
HT-D-21179-1	4-12
HT-D-21179-2	4-12
HT-D-21291-1	4-12
HT-D-21291-2	4-12
HT-D-21497-1	4-12
HT-D-21808-1	4-12
HT-D-22179-1	4-10/12
HT-D-22179-2	4-10/12
HT-RAILE-198	4-13
HT-S-1128	3-29
HT-S-11613	4-5/6/7/8/9/10
HT-S-1314	3-30
HT-S-14102	4-15
HT-S-14104	4-15
HT-S-14108	4-13/15
HT-S-14179	3-29
HT-S-14231-8	4-15
HT-S-14342-1	4-15
HT-S-14342-3	4-15
HT-S-14587-1	4-12
HT-S-14587-8	4-12
HT-S-20000-1	4-5/6/7
HT-S-20000-2	4-5/6/7
HT-S-20001	4-5/12
HT-S-2000-1	4-8
HT-S-20002	4-7/12
HT-S-2000-2	4-8
HT-S-20010	4-7/15
HT-S-20031	4-7
HT-S-20031/2	4-5/6/8/9/12
HT-S-20032/4	4-5/6/7/8/9/12
HT-S-20069	4-7/9
HT-S-20124	4-9/15
HT-S-20126	4-12
HT-S-20127	4-15
HT-S-20217	4-15
HT-S-20223	4-5/15
HT-S-20700	4-7
HT-S-20701	4-5/6/7/8/9
HT-S-20837-1	4-10
HT-S-20924	4-6/8/10

# Index by Part Number



HT-S-20925	4-6/8/10
HT-S-21181	4-10
HT-S-21292	4-6/8
HT-S-21292	4-12
HT-S-21477-8	4-15
HT-S-2160	4-12
HT-S-21784	4-15
HT-S-21800	4-10/15
HT-S-21966	4-15
HT-S-22045	4-6/15
HT-S-22046	4-8/15
HT-S-220700	4-5
HT-S-22366	4-13
HT-S-22948	4-10/15
HT-S-23460	3-29
HT-S-23566	4-12
HT-S-23649	4-12
HT-S-23650	4-12
HT-S-23974	4-10
HT-S-24021	4-12
HT-S-24024	4-12
HT-S-24049/2	4-12
HT-S-24053	3-29
HT-S-24088	4-10/12
HT-S-24247-1	4-10
HT-S-24459	4-13
HT-S-24460	4-13
HT-S-24495	3-30; 4-12
HT-S-24636-1L	4-10
HT-S-24636-1R	4-10
HT-S-24679	4-6/8/11
HT-S-24680	4-11
HT-S-24691	4-6/8/11
HT-S-24705	4-10/11
HT-S-25516	3-30; 4-12
HT-S-25593	3-30; 4-12
HT-S-26321	4-10/11
HT-S-2770	4-5/7/9
HT-S-3646	4-5/7/9/11
HT-S-3650/4	4-12
HT-S-6914	4-5/7/9/11
HT-S-9951	3-29
HT-VS-22535	3-30
HT-VS-227	3-29
HT-VS-25223	3-30
HT-VS-25849	3-30
HT-VS-27116	3-29
HT-VS-28048	3-29
HU-10775-00	4-38
HU-11410-00	4-27/32

HU-11414-00	4-28
HU-11420-00	4-27/32
HU-11421-01	4-27/29/30/32
HU-11485-15	4-32
HU-11641-05	4-32
HU-11642-07	4-32
HU-11642-08	4-32
HU-11642-10	4-32
HU-11953-01	4-37/46
HU-12713-28	4-29/30/31
HU-12713-31	4-31
HU-12715-01	4-32
HU-12716-01	4-32
HU-12779-01	4-27/33
HU-12781-01	4-27/33
HU-12818-01	4-28/32
HU-16006-01	4-27/32
HU-161169-01	4-35
HU-16158-01	4-36
HU-16159-03	4-36
HU-16167-03	4-37/46
HU-16167-04	4-37/46
HU-16168-09	4-36
HU-16171-01	4-35
HU-16185-01	4-35
HU-16238-05	4-33
HU-16293-01	4-35
HU-16293-02	4-35
HU-16319-01	4-36
HU-16398-01	4-37
HU-16398-02	4-37
HU-16398-03	4-37
HU-16398-04	4-37
HU-16398-06	4-37
HU-16398-12	4-37
HU-16816-25	4-31
HU-16868-01	4-39
HU-17708-01	4-33
HU-17784-01	4-36
HU-18010-01	4-30
HU-18150-19	4-31
HU-18426-01	4-32
HU-18723-01	4-36
HU-18797-01	4-29
HU-19033-01	4-30
HU-19033-03	4-29/30
HU-19137-01	4-36
HU-19360-01	4-38
HU-19360-02	4-38
HU-19360-03	4-38

HU-19360-04	4-38
HU-19360-05	4-38
HU-19360-06	4-38
HU-19360-07	4-38
HU-19360-08	4-38
HU-19360-09	4-38
HU-19361-01	4-39
HU-19361-04	4-39
HU-19364-01	4-38
HU-19364-02	4-38
HU-19365-01	4-38
HU-20289-01	4-29/30/32
HU-20728-01	4-34
HU-20729-01	4-34
HU-20730-01	4-34
HU-20732-01	4-34
HU-20733-01	4-34
HU-20734-01	4-34
HU-22215-01	4-38
HU-7010-00	4-36
HU-702-01	4-35
HU-7028-00	4-39
HU-7030-00	4-39
HU-7052-02	4-41
HU-706-01	4-39
HU-710-00	4-39
HU-715-00	4-37
HU-719-04	4-39
HU-750-03	4-36
HU-755-03	4-39
HU-759-00	4-39
HU-7601-01	4-35
HU-7701-01	4-34
HU-7701-05	4-35
HU-7701-06	4-35
HU-7701-07	4-34
HU-7701-08	4-34
HU-7702-01	4-34
HU-7702-02	4-34
HU-7702-03	4-34
HU-7702-05	4-34
HU-7703-01	4-34
HU-7703-05	4-35
HU-7703-06	4-35
HU-7703-07	4-34
HU-7703-08	4-34
HU-7707-14	4-35
HU-7717-01	4-39
HU-7746-00	4-39
HU-7747-01	4-39

HU-7750-02	4-36
HU-77ABW	4-37
HU-8018-01	4-28/32
HU-8018-02	4-27/29/30/32
HU-8019-01	4-32
HU-8032-07	4-32
HU-8032-08	4-32
HU-8032-09	4-32
HU-8032-10	4-32
HU-8035-00	4-33
HU-8050-00	4-33
HU-8098-01	4-27/28/33
HU-814-00	4-41
HU-8178-04	4-28/31
HU-8200-42-NO-RLS	4-27
HU-8200-42-RLS-SUSP	4-27
HU-8200-48-NO-RLS	4-27
HU-8426-01	4-33
HU-8500-38-NO-RLS	4-28
HU-8520-00	4-32
HU-9239-10	4-36
HU-9249-00	4-33
HU-9611-01	4-32
HU-9700MAC-3/4-STM	4-26
HU-9700MAC-3/4-UM	4-26
HU-9700MAC-3/4-UM-US	4-26
HU-9700S-3/4-STM	4-26
HU-9700S-3/4-UM	4-26
HU-9700S-3/4-UM-US	4-26
HU-97ABW	4-37
HU-9801-42-NO-RLS	4-30
HU-9801-48-NO-RLS	4-30
HU-9801-48-RLS-SUSP	4-30
HU-9811-48-NO-RLS	4-29
HU-9811-48-RLS-SUSP	4-29
HY-70000-814-155D	17-4
HY-70000-815-180D	17-4
HY-70000-815-180DE	17-4
HY-70000-815-210D	17-4
HY-70000-815-210DE	17-4
HY-70000-815-235D	17-4
HY-70000-815-250D	17-4
HY-70000-815-265D	17-4
HY-70000-815-265DE	17-4
HY-70022-815-210D	17-4
JK-300	17-1
JK-300LID	17-1
JK-350	17-1
JK-350LID	17-1
JK-500	17-1

JK-550	17-1
JO-700-4-390S	5-11
JO-700-4-391GB	5-11
JO-700-4-392NGB	5-11
JO-700-4-393S	5-13
JO-700-4-394GB	5-13
JO-700-4-395NGB	5-13
JO-700-4-402S	5-11
JO-700-4-403GB	5-11
JO-700-4-404NGB	5-11
JO-700-4-410S	5-13
JO-700-4-411GB	5-13
JO-700-4-412NGB	5-13
JO-700-4-443S	5-11
JO-700-4-444GB	5-11
JO-700-4-445NGB	5-11
JO-700-4-498S	5-11
JO-700-4-499GB	5-11
JO-700-4-500NGB	5-11
JO-A10048	5-12/14
JO-A10049	5-12/14
JO-A10054.7	5-12/14
JO-A10255	5-12/14
JO-A10260.1	5-12/14
JO-A10283	5-12/14
JO-B10036	5-12/14
JO-B10066.77.4	5-12/14
JO-B10130	5-12/14
JO-B10229	5-12/14
JO-B10236	5-12/14
JO-B10261	5-12/14
JO-B10285	5-12/14
JO-C10035	5-12/14
JO-C10078	5-12/14
JO-C10085	5-12/14
JO-C10108	5-12/14
JO-C10155	5-12/14
JO-C10177	5-12/14
JO-C10217	5-12/14
JO-C10233	5-12/14
JO-C10234	5-12/14
JO-C10592.2	5-12/14
JO-C10717	5-33
KI-10032	13-8
KI-10033	13-8
KI-10035	13-9
KI-10062	13-3
KI-10072	13-2
KI-10078	13-2
KI-10085	13-3

KI-10086	13-3
KI-10088	13-3
KI-10091	13-6
KI-10096	13-3
KI-10109	13-9
KI-10120	13-9
KI-10125-31	13-3
KI-1020	13-7
KI-10427-45	13-10
KI-12015	13-7
KI-13002	13-7
KI-13008	13-7
KI-1524	8-60
KI-1816-1	13-1
KI-1816-2	13-1
KI-1818-1	13-1
KI-1818-2	13-1
KI-1820	13-6
KI-1820P2	13-6
KI-1845	13-2
KI-1863	13-8
KI-2005	13-1
KI-2019	13-1
KI-322721	13-5
KI-3606	13-8
KI-3607	13-8
KI-3608	13-8
KI-37024	13-8
KI-37025	13-8
KI-37030	13-8
KI-37031	13-8
KI-3820	13-7
KI-422710	13-6
KI-422721	13-5
KI-423010	13-6
KI-423021	13-5
KI-423030	13-6
KI-423421	13-5
KI-43001	13-1
KI-43002	13-1
KI-512720	13-5
KI-513020	13-5
KI-532720	13-5
KI-5820	13-7
KI-593021	13-5
KI-641201	13-4
KI-641202	13-4
KI-641601	13-4
KI-642001	13-4
KI-651201	13-4

# Index by Part Number



KI-651202	13-4
KI-651601	13-4
KI-651602	13-4
KI-660001	13-4
KI-7190	13-10
KI-7820	13-6
KI-7820P2	13-6
KI-FE7053-1	13-2
KI-FE7955-8	13-2
KI-FE8000-1	13-1
KI-FE8000-12	13-1
KI-FE8066-1	13-1
KI-FE8066-3	13-1
KI-FF877	13-2
KI-JB101	13-2
KI-JB102	13-2
KI-JB109	13-2
KL-075X103X31ETR	7-40
KL-075X103X500	7-40
KL-075X103X55ETR	7-40
KW-1051-A1	5-18/22
KW-1402-A7	5-18/22
KW-1453-A1	5-16/18/20/22
KW-1453-A40	5-16/18/20/22
KW-1453-A5	5-16/18/20/22
KW-1453-A61	5-18/22
KW-6363-1	5-18/22
KW-6364-1	5-18/22
KW-6365-1	5-18/22
KW-6884-70	5-16/18/20/22
KW-6943-2	5-18/22
KW-6948-1	5-16/18/20/22
KW-6956-1	5-16/18/20/22
KW-700-4-358S	5-15
KW-700-4-359GB	5-15
KW-700-4-360NGB	5-15
KW-700-4-361S	5-15
KW-700-4-362GB	5-15
KW-700-4-363NGB	5-15
KW-700-4-372S	5-19
KW-700-4-373GB	5-19
KW-700-4-374NGB	5-19
KW-700-4-454S	5-15
KW-700-4-455GB	5-15
KW-700-4-456NGB	5-15
KW-700-4-509S	5-15
KW-700-4-510GB	5-15
KW-700-4-511NGB	5-15
KW-741158	5-16/20
KW-751173	5-16/20

KW-751174	5-16/20
KW-751175	5-16/20
KW-751601	5-16
KW-760107	5-35
KW-8984	5-18/22
KW-8994	5-18/22
KW-9366-3	5-18/22
KW-J-27-BX-3	5-16/18/20/22
KW-J-3237	5-18/22
KW-J-4154	5-16/18
KW-J-4890	5-20/22
KW-J-4928-1	5-16/18/20/22
KW-J-5309	5-16/18/20/22
KW-J-5310-1	5-18/22
KW-J-5311-1	5-16/18/20/22
KW-J-5312-1	5-18/22
KW-J-5313	5-18/22
KW-J-7153	5-16/18/20/22
LB-1003T	9-11
LB-1004T	9-12
LB-1141T	9-11
LB-1155T	9-11
LB-1156T	9-11
LB-1157NAT	9-12
LB-1157T	9-12
LB-161T	9-11
LB-168T	9-12
LB-1889T	9-11
LB-1891T	9-11
LB-1893T	9-11
LB-1895T	9-11
LB-194T	9-12
LB-198T	9-11
LB-199T	9-11
LB-293T	9-11
LB-3156T	9-11
LB-3157NAT	9-11
LB-3157T	9-11
LB-4000	9-9
LB-4411	9-9
LB-4412	9-9
LB-4412A	9-9
LB-4415	9-9
LB-4416	9-9
LB-4421	9-9
LB-4509	9-9
LB-4537	9-9
LB-4652	9-10
LB-53T	9-11
LB-57T	9-11

LB-6014	9-10
LB-6015	9-10
LB-6052	9-10
LB-67T	9-11
LB-89T	9-11
LB-9004	9-11
LB-97T	9-11
LB-H4651	9-10
LB-H4656	9-10
LB-H6024	9-10
LB-H6054	9-10
LM-126CLR	12-10
LM-126CT	12-10
LM-80SM/S97	12-11
LM-80SM-01	12-11
LM-80SM97	12-11
LM-81-8FO	12-10
LM-81-8SFO	12-10
LM-81-8WFO	12-10
LM-81-ACFO	12-10
LM-81-CLIP-1	12-11
LM-97-14WAF	12-10
LM-RT14	12-10
LM-RT18	12-10
LT-24200	15-5
LT-25218	17-3
LT-27010	15-5
LT-27100	15-5
LT-27140	15-5
LT-56521	15-5
LT-80016	15-6
LT-80022	15-6
LT-80050	15-5
LT-80072	15-5
LT-80078	15-6
LT-80577	15-6
LT-80632	15-5
LT-81158	15-5
LT-81464	15-6
LT-81724	15-6
LT-81731	15-5
LT-81833	15-5
LT-81878	15-6
LT-81943	15-6
LT-82180	15-6
LT-99070	15-6
LU-CC01	7-5
LU-CC02	7-5
LU-RB01	7-38
LU-SP01	7-25

LU-SP03P	7-25
LU-TR01-624	7-15
MA-30-A-GRAY	15-1
MA-30-A-WHITE	15-1
MA-501-A-GRAY	15-1
MA-501-A-WHITE	15-1
MA-64-A	15-3
MA-65-A-GRAY	15-1
MA-65-A-WHITE	15-1
MA-65-B	15-2
MA-65-H	15-2
MA-73-A-BLACK	15-1
MA-73-A-CLEAR	15-1
MA-73-A-GRAY	15-1
MA-73-A-WHITE	15-1
MA-76-AM	15-2
MA-ALUM-A-FOIL	15-3
MA-WHITE-FOIL	15-3
MG-3230008	3-7
MG-3230051	3-7
MG-3430008	3-7
MG-3430051	3-7
MG-3430551	3-7
MG-8017830	3-7
MI-AL364040	3-24
MI-AQ960503	3-24
MI-BE23402	9-3
MI-BE23403	9-1
MI-BE23602	9-3
MI-BE23603	9-1
MI-BE23703	9-4
MI-BE23784	9-1
MI-BE24000	9-3
MI-BE24001	9-3
MI-BE24020	9-2
MI-BE24030	9-2
MI-BE26100	3-10
MI-BE26103	3-10
MI-BQ24002	9-5
MI-KN20903	3-24
MI-KN26020	3-24
MI-KN28510	3-24
MI-KN28520	3-24
MI-KN28600	3-24
MI-KN28601	3-24
MI-KN30400	3-24
MI-KN32005	3-24
MI-KN32011	3-24
MN-1064	8-26
MN-4005	8-26

MN-4006	8-26
MN-4011	8-26
MN-4012	8-26
MN-4042	8-26
MN-4043	8-26
MN-4044	8-26
MN-4049	8-26
MN-4090	8-26
MN-4140	8-26
MN-4141	8-26
MN-4142	8-26
MN-4207	8-26
MN-4208	8-26
MN-P108630A	8-13
MN-P10871A	8-13
MN-P108940A	8-13
MP-000056	7-41
MP-000085	7-41
MP-000096	7-41
MP-0001409	7-41
MP-00015904	7-41
MP-0001709	7-41
MP-00033901	7-41
MP-000745	7-42
MP-00078	7-42
MP-000785	7-42
MP-00146	7-43
MP-001481	7-42
MP-00165	7-42
MP-006528	7-43
MP-00659	7-44
MP-00660	7-44
MP-006671	7-44
MP-0066710	7-44
MP-00695	7-46
MP-00696	7-46
MP-0069601	7-46
MP-01901	7-43
MP-01902	7-43
MP-019033	7-43
MP-019034	7-43
MP-019083	7-43
MP-019084	7-43
MP-02192	7-46
MP-0985067	7-46
MP-1121813	7-45
MP-1121823	7-45
MP-1198653	7-45
MP-1198654	7-45
MP-11986540	7-45

MP-12406	7-43
MP-12407	7-43
MP-13500	7-43
MP-13502	7-43
MP-13547	7-44
MP-1403809	7-42
MP-14142	7-43
MP-14211	7-42
MP-62660	7-44
MP-62661	7-44
MP-62664	7-44
MP-62665	7-44
MP-6480161	7-44
MP-6480285	7-44
MP-648031	7-44
MP-A0000119	7-42
MP-HB01	7-45
MP-HB02	7-45
MP-HG01	7-45
MP-HG02	7-45
MW-10013-W	2-11
MW-825225DVL	2-12
MW-825225DVL-W	2-12
MW-825245DVL	2-12
MW-825245DVL-W	2-12
MW-87101B	2-5
MW-87128B	2-5
MW-87156B	2-5
MW-87295B	2-6
MW-87407B	2-5
MW-87415B	2-5
MW-87417B	2-5
MW-87615B	2-5
MW-87897	2-11
MW-87897-W	2-11
MW-87905	2-11
MW-87905-W	2-11
MW-87945BK	2-6
MW-88797B	2-5
MW-88870BK	2-6
MW-89403	2-3
MW-89404B	2-2
MW-89425	2-3
MW-89651B	2-5
MW-89870BK	2-6
MW-89877BK	2-6
MW-89922-W	2-11
MW-89996B	2-5
MW-90089BK	2-6
MW-90262	2-11

# Index by Part Number



MW-90262-W	2-11
MW-90541-W	2-11
MW-90542-W	2-11
NA-370001A	1-21
NA-370003A	1-21
NA-370022A	1-21
NA-370025A	1-21
NA-370031A	1-21
NA-370036A	1-21
NA-370065A	1-21
NA-370131A	1-21
NA-376590A	1-21
NA-380001A	1-21
NA-380003A	1-21
NA-380023A	1-21
NA-380025A	1-21
NA-380036A	1-21
NA-380065A	1-21
NE-48100025	4-3
NE-48100033	4-4
NE-48100050	4-4
NE-48100108	4-3
NE-48100202	4-3
NE-48100206	4-3
NE-48100225	3-27
NE-48100267	3-27
NE-90001006	4-2
NE-90001045	4-2
NE-90001082	4-2
NE-90008139	4-2
NE-90008147	4-3
NE-90008149	4-2
NE-90008186	4-2
NE-90010032	4-2
NE-90028047	4-2
NE90028073	4-2
NE-90028083	4-2
NE-90031027	4-2
NE-90036177	4-3
NE-90041878	4-3
NE-90042791	4-3
NE-90042792	4-3
NE-90044089	4-1
NE-90044162	4-1
NE-90044625	4-1
NE-90044626	4-1
NE-90044642	4-1
NE-90054007	3-27
NE-90054074	3-27
NE-90054075	3-27

NE-90054082	3-27
NE-90054088	3-27
NE-90054700	3-28
NE-90508009	4-3
NE-90516112	4-3
NE-90516113	4-3
NE-90519425	4-2
NE-90554107	3-28
NE-90554241	3-27
NE-90554271	3-27
NE-90554335	3-27
NE-90554615	3-27
NE-90554630	3-27
NE-90554664	3-28
NE-90557023	4-1
NE-90557027	4-1
NE-90557112	4-1
NE-90557113	4-1
NE-90557121	4-1
NE-90557223	4-1
NE-90557225	4-1
NE-91001051	4-4
NE-91008022	4-4
NE-91010047	4-4
NE-93201045	4-3
NE-93201051	4-3
NE-93201055	4-3
NE-93400506	4-3
NE-93900027	4-3
NE-AC-84-S-1	3-28
PB-216P-12-8	3-22
PH-15-720	9-4
PH-15-830	9-1
PH-16-724	9-3
PH-16-730	9-1
PH-16-777	9-5
PH-16-822	9-3
PH-16-826	9-3
PH-30-9620	9-7
PH-31-9623	9-7
PI-CC01	7-5
PM-100-15A	10-10
PM-100-15R	10-10
PM-100A	10-8
PM-100R	10-8
PM-104A	10-8
PM-104R	10-8
PM-106-09	10-11
PM-106A	10-8
PM-106R	10-8

PM-107-15A	10-10
PM-107-15R	10-10
PM-107-3R	10-11
PM-107WA	10-8
PM-107WR	10-8
PM-108-15A	10-10
PM-108-15R	10-10
PM-108WA	10-8
PM-108WR	10-8
PM-119A	10-8
PM-119R	10-8
PM-122-15R	10-10
PM-122A	10-8
PM-122R	10-8
PM-124A	10-8
PM-124R	10-8
PM-130-25A	10-10
PM-130-25R	10-10
PM-130A	10-8
PM-130R	10-8
PM-134-15A	10-10
PM-134-15R	10-10
PM-135A	10-8
PM-135R	10-8
PM-138-15A	10-10
PM-138-15R	10-10
PM-138A	10-8
PM-138R	10-8
PM-139-18	10-11
PM-141A	10-8
PM-141R	10-8
PM-142A	10-9
PM-142R	10-9
PM-146A	10-9
PM-146R	10-9
PM-1973	10-11
PM-390S	10-9
PM-408	10-9
PM-410-15A	10-10
PM-410-15R	10-10
PM-410-21	10-11
PM-411-07	10-11
PM-411SC	10-11
PM-413-07	10-11
PM-413-3	10-9
PM-413-S	10-9
PM-414-15C	10-10
PM-415-25R	10-10
PM-420-15	10-9
PM-420-15	10-10

PM-425S-21	10-11
PM-426A	10-9
PM-426R	10-9
PM-428W	10-9
PM-430-25	10-10
PM-430L	10-9
PM-430R	10-9
PM-431-491	10-11
PM-436	10-9
PM-440	10-9
PM-45	17-1
PM-460A	10-7
PM-460R	10-7
PM-472A	10-7
PM-472R	10-7
PM-475A	10-7
PM-475R	10-7
PM-476A	10-7
PM-476R	10-7
PM-477A	10-7
PM-477R	10-7
PM-480A	10-7
PM-480R	10-7
PM-481A	10-7
PM-481R	10-7
PM-490A	10-7
PM-490R	10-7
PM-491A	10-7
PM-491R	10-7
PM-95-18	10-11
PM-96A	10-9
PM-96R	10-9
PP-5001200055	16-2
PP-5001205203	16-2
PP-5001206021	16-2
PP-5415005203	16-2
PP-5900300120	16-2
PP-5900335203	16-2
PP-5900735203	16-2
PP-5921200120	16-2
PP-5921212091	16-2
PP-5921235203	16-2
PP-6520800055	16-2
PP-6520805203	16-2
PP-7042830141	16-2
PP-7042835203	16-2
PP-7046035203	16-2
PP-7112502120	16-2
PP-7112530141	16-2
PP-9401000055	16-3

PP-9401006021	16-3
PZ-04-40-56-72	5-28
PZ-04-80-26-41	5-28
PZ-04-80-56-72	5-28
PZ-08-02	7-63
QC-2245QC	12-14
QC-2247QC	12-14
QC-2249QC	12-14
RG-68000903	13-11
RG-68100005	13-11
RG-68100006	13-11
RG-68100024	13-11
RG-68200008	13-10
RG-68200100	13-10
RG-68200102	13-10
RI-6240013	3-26
RI-6240031	3-26
RI-6240605	3-26
RP-1011K-PPW	7-7
RP-102K-PPW	7-6
RP-102-SST	7-6
RP-115-MFA	7-7
RP-130-PPG	7-6
RP-2038-MFA	7-7
RP-205-SST	7-7
RP-444-MFA	7-6
RP-881K-PPW	7-6
RP-881-MFA	7-6
RP-881-PPW	7-6
RP-881-SST	7-6
RP-881X-PPW	7-6
RP-883K-PPW	7-6
RP-888-SST	7-6
RP-958K-PPW	7-6
RP-958-SST	7-6
RW-19X1084	1-15
RW-19X127	1-15
RW-226051111	1-15
RW-31313-26	3-31
RW-31314-21	3-31
RW-31316-03	3-32
RW-31363-00	3-32
RW-31373-00	3-32
RW-31965-22	3-31
RW-32202-01-A	3-31
RW-32282-00	3-32
RW-85919	4-57
RW-A13133Y8345	4-57
RW-A2258F1410	4-57
RW-A3133G8249	4-57

RW-B7420N1002	4-57
RW-KIT11102	4-57
RW-KIT11106	4-57
RW-KIT11107	4-57
RW-KIT11117	4-57
RW-KIT11300	4-58
RW-KIT11301	4-58
RW-KIT8000	1-4
RW-KIT8289	1-11
RW-KIT963	1-15
RW-KITSTPN	1-18
RW-R000573	1-18
RW-R009095	1-17
RW-R801003	1-15
RW-R801041	1-15
RW-R801042	1-15
RW-R801072	1-15
RW-R801073	1-15
RW-R801074	1-15
RW-R801102	1-15
RW-R801700	1-15
RW-R810019	1-15
RW-R955320	3-25
RW-R955335	3-25
RW-R955344	3-25
RW-R955378	3-25
RW-S4005001010	3-25
RW-S4005001030	3-25
RW-S4493260600	3-25
RW-S4493280300	3-25
RW-S4497130180	3-25
RW-S4497130300	3-25
RW-S4721950330	3-25
RW-S8946049440	3-25
RW-S8946049450	3-25
RW-S8946060380	3-25
RW-S8946060500	3-25
RW-S8946060510	3-25
RW-S8946073130	3-25
RW-S8997598154	3-25
RW-TN4671LR7250	1-1
RW-TN4671QR1150	1-1
RW-TN4671QR7150	1-1
RW-TP4671QR1250	1-1
RW-TP4671QR7150	1-1
RW-TP8671QR7350	1-1
RW-TQ4671LR7350	1-1
RW-TQ4671QR1350	1-1
RW-TQ4671QR7350	1-1
RY-0001-02	4-54



# Index by Part Number



RY-0001-04	4-54
RY-0002-07	4-54
RY-0022-01	4-53
RY-0045-00	4-54
RY-0046-20	4-52
RY-0051-20	4-52
RY-0062-20	4-52
RY-0075-20	4-53
RY-0079-01	4-55
RY-0079-02	4-56
RY-0084-00	4-52
RY-0086-00	4-52
RY-0088-00	4-52
RY-0400-01	4-53
RY-0400-02	4-53
RY-0401-00	4-53
RY-0402-01	4-53
RY-0402-02	4-53
RY-0415-00	4-54
RY-0538-00	4-54
RY-0636-01	4-54
RY-0636-02	4-54
RY-0649-04	4-53
RY-0650-00	4-53
RY-0741-01	4-54
RY-07980-01	4-51
RY-08376-01	4-56
RY-08480-01	4-51
RY-0850-00	4-53
RY-08677-01	4-51
RY-09139-01	4-51
RY-09729-01	4-55
RY-09730-01	4-51
RY-10114-01	4-51
RY-1035-20	4-53
RY-10910-01	4-54
RY-11799-01	4-50
RY-15172-01	4-51
RY-15173-01	4-51
RY-15178-01	4-51
RY-15179-01	4-51
RY-15186-01	4-55
RY-15354-01	4-55
RY-15636-01	4-55
RY-19786-48	4-54
RY-19913-01	4-54
RY-19914-01	4-54
RY-21725-01	4-50
RY-T2106	4-52
RY-T5424	4-50

RY-T5425	4-50
RY-T5426	4-50
RY-T5428	4-50
RY-T5429	4-50
RY-T5495	4-55
RY-T5544	4-52
RY-T5562	4-50
RY-T5563	4-50
RY-T5564	4-50
RY-T5565	4-50
RY-T5566	4-50
RY-T7175	4-51
RY-T7655	4-52
RY-T7716	4-52
RY-TK12506	4-50
RY-TK18997	4-51
RY-TK19011	4-52
RY-TK21640T	4-55
SL-110139	3-18
SL-110165	3-22
SL-110170	3-20
SL-110171	3-20
SL-110175	3-22
SL-110191	3-20
SL-110197	3-19
SL-110198	3-19
SL-110200	3-18
SL-110205	3-18
SL-110310	3-20
SL-110338	3-18
SL-110360	3-19
SL-110365	3-19
SL-110380	3-18
SL-110410	3-19
SL-110415	3-18
SL-110500	3-19
SL-110570	3-20
SL-110580	3-20
SL-110609	3-22
SL-110800	3-19
SL-140270	3-21
SL-140280	3-21
SL-17600B	3-20
SL-200000	3-21
SL-200002	3-21
SL-21600	3-21
SL-216200	3-21
SL-3100	3-20
SL-3800	3-21
SL-5400	3-21

SL-6006	3-22
SL-616	3-22
SL-617	3-22
SL-780210	3-21
SL-9125	3-19
SL-A10005	3-18
SM-300-4009	1-21
SM-307-0713	1-21
SM-307-0723	1-21
SM-307-0743	1-21
SM-307-0744	1-21
SM-308-0836	1-21
SM-309-0973	1-21
SM-330-3009	1-21
SM-330-3024	1-21
SM-330-3067	1-21
SM-330-3107	1-21
SM-330-3118	1-21
SM-330-3122	1-21
SM-340-4009	1-21
SM-340-4013	1-21
SM-340-4019	1-21
SM-340-4024	1-21
SM-340-4046	1-21
SM-340-4059	1-21
SM-340-4075	1-21
SM-340-4095	1-21
SM-340-4195	1-21
SM-340-4249	1-21
SM-340-5096	1-21
SM-340-5097	1-21
SM-342-4009	1-21
SM-342-4075	1-21
SM-342-4339	1-21
SM-343-4009	1-21
SM-343-4013	1-21
SM-343-4024	1-21
SM-343-4075	1-21
SM-343-4095	1-21
SM-343-4195	1-21
SM-343-4249	1-21
SM-343-4350	1-21; 3-32
SM-347-4009	1-21
SM-347-4013	1-21
SM-347-4075	1-21
SM-347-4195	1-21
SM-348-4009	1-21
SM-359-5912	1-21
SM-359-5915	1-21
SM-359-5990	1-21

SM-359-5992	1-21
SM-359-5995	1-21
SM-359-5999	1-21
SM-359-6095	1-21
SM-359-6117	1-21
SM-359-6124	1-21
SM-372-7015	1-21
SM-372-7062	1-21
SM-372-7097	1-21
SM-372-7098	1-21
SM-372-7099	1-21
SM-373-0144	1-21
SM-382-8036	1-21
SM-392-9094	1-21
SM-392-9099	1-21
SM-392-9112	1-21
SM-392-9131	1-21
SM-447-4723	1-18
SM-447-4743	1-18
SM-610-0006	1-23
SM-610-0007	1-23
SM-610-0011	1-23
SM-610-0024	1-23
SM-610-0065	1-23
SM-610-0085	1-23; 3-32
SM-640-0001	1-21
SM-640-0003	1-21
SM-650-0587	1-24
SM-650-0593	1-24
SM-650-0598	1-24
SM-650-0601	1-24
SM-650-0605	1-24
SM-650-0608	1-24
SM-650-0610	1-24
SM-650-0619	1-24
SM-650-0626	1-24
SO-BR01-621	7-19
SO-CC01	7-5
SO-RB01	7-38
SO-RP02	7-10
SO-TR01-621	7-16
SS-102	9-14
SS-1203	10-24
SS-1203A	10-24
SS-1211	10-26
SS-1211A	10-26
SS-1259	10-25
SS-1259A	10-25
SS-3812	10-38
SS-4027D	10-38

SS-5013	10-38
SS-5014	10-38
SS-5015	10-38
SS-5016	10-38
SS-5800AAK	10-38
SS-9075	10-37
SS-9077	10-37
SS-9077A	10-37
SS-9464	10-38
ST-CC01	7-5
ST-CC02	7-5
ST-CC03	7-5
ST-RB01	7-38
ST-RP01	7-10
ST-RP02	7-10
ST-RP03	7-10
ST-RP04	7-11
ST-RP05	7-11
ST-RP06	7-11
ST-RP07	7-11
ST-SP01	7-25
TA-440TX25	14-9
TA-440TX30	14-9
TA-4802	14-9
TA-4803	14-9
TA-480TX30	14-9
TA-480TX40	14-9
TA-480TX50	14-9
TA-480TX55	14-9
TA-855	14-9
TA-858	14-9
TA-9502	14-9
TA-S720	14-8
TA-S721	14-8
TA-S722	14-8
TA-S723	14-8
TA-S729	14-8
TA-S731	14-8
TA-S821	14-8
TB-14-2	12-12
TB-16-2	12-12
TB-18-1	12-12
TB-18-2	12-12
TB-20-1	12-12
TB-20-2	12-12
TB-37-131	12-13
TB-37-160	12-13
TB-37-180	12-13
TB-37-189	12-13
TB-37-201	12-13

TB-37-209	12-13
TB-37-220	12-13
TB-37-240	12-13
TB-61-130	12-12
TB-61-140	12-12
TB-61-150	12-12
TB-61-151	12-12
TB-61-180	12-12
TB-63-140	12-12
TB-63-151	12-12
TB-63-180	12-12
TB-63-181	12-12
TB-65-200	12-12
TB-66-150	12-13
TK-3720	1-19
TK-3782	1-19
TK-401	1-19
TK-403	1-19
TK-405	1-19
TK-406	1-19
TK-413	1-19
TK-414	1-19
TK-415	1-19
TK-563	1-19
TK-567	1-19
TK-572	1-19
TK-580	1-19
TK-582	1-19
TK-592A	1-19
TK-593	1-19
TK-594A	1-19
TK-598A	1-19
TK-653	1-19
TK-663	1-19
TK-665A	1-19
TK-HH506310	1-19
TK-HH506348	1-19
TK-HM212011	1-19
TK-HM212047	1-19
TK-HM212049	1-19
TK-HM218210	1-19
TK-HM218248	1-19
TK-HM518410	1-19
TK-HM518445	1-19
TL-00814	10-18
TL-00814	10-36
TL-10050R	10-22
TL-10050Y	10-22
TL-10202C	10-35
TL-10202R	10-22

# Index by Part Number



TL-10202Y	10-22
TL-10203R	10-36
TL-10203Y	10-36
TL-10205R	10-22
TL-10205Y	10-22
TL-10208R	10-22
TL-10208Y	10-22
TL-10212Y	10-22
TL-10401	10-14
TL-10402	10-14
TL-10403	10-14/15
TL-10404	10-14
TL-10410	10-13
TL-10414	10-14
TL-10720	10-14
TL-10729	10-14
TL-10738	10-14
TL-10744R	10-36
TL-10745R	10-36
TL-12003R	10-22
TL-12003Y	10-22
TL-1264	10-25
TL-1264A	10-25
TL-14200R	10-22
TL-14200Y	10-22
TL-14700	10-15
TL-15001R	10-23
TL-15001Y	10-23
TL-15006R	10-23
TL-15006Y	10-23
TL-15008R	10-23
TL-15008Y	10-23
TL-15011	10-34
TL-1507	10-25
TL-15200C	10-34
TL-15200R	10-22
TL-15200Y	10-22
TL-15208	10-34
TL-15250R	10-22
TL-15250Y	10-22
TL-15401	10-16
TL-15404	10-16
TL-15405	10-16
TL-15406	10-16
TL-15407	10-16
TL-15413	10-16
TL-15414	10-16
TL-15702	10-16
TL-15729	10-16
TL-15741R	10-36

TL-17001	10-34
TL-17002	10-34
TL-172	9-12
TL-17720	10-16/34
TL-18300R	10-23
TL-18300Y	10-23
TL-19001R	10-23
TL-19001Y	10-23
TL-19002R	10-23
TL-19002Y	10-23
TL-19200C	10-34
TL-19200R	10-23
TL-19200Y	10-23
TL-19206	10-34
TL-19250R	10-23
TL-19250Y	10-23
TL-19720	10-16
TL-19721	10-16
TL-19722	10-16
TL-19724	10-16
TL-20300Y	10-24
TL-20303Y	10-24
TL-20304Y	10-31
TL-21001R	10-24
TL-21001Y	10-24
TL-21002R	10-24
TL-21002Y	10-24
TL-21004C	10-34
TL-21051R	10-24
TL-21051Y	10-24
TL-21200R	10-24
TL-21200Y	10-24
TL-21201R	10-24
TL-21201Y	10-24
TL-21501R	10-24
TL-21501Y	10-24
TL-21720	10-17
TL-22002Y	10-31
TL-22004R	10-31
TL-22004Y	10-31
TL-25760Y	10-36
TL-25761Y	10-36
TL-26310R	10-25
TL-26310Y	10-25
TL-26330	10-34
TL-26331	10-34
TL-26335	10-34
TL-26720	10-17
TL-26762Y	10-36
TL-26765Y	10-36

TL-26771Y	10-36
TL-30050R	10-26
TL-30050Y	10-26
TL-30051R	10-26
TL-30051Y	10-26
TL-30200C	10-35
TL-30200R	10-25
TL-30200R	10-25
TL-30200Y	10-25
TL-30200Y	10-25
TL-30201R	10-26
TL-30201Y	10-26
TL-30221R	10-25
TL-30221Y	10-25
TL-30222R	10-25
TL-30222Y	10-25
TL-30257Y	10-25/26
TL-30400	10-13
TL-30401	10-13
TL-30402	10-13
TL-30403	10-13
TL-30404	10-13
TL-30405	10-13
TL-30407	10-13
TL-30503R	10-25
TL-30503Y	10-25
TL-30728	10-13
TL-30740R	10-36
TL-35001R	10-26
TL-35001Y	10-26
TL-35080R	10-26
TL-35720	10-17
TL-40002R	10-27
TL-40002Y	10-27
TL-40004	10-33
TL-40015R	10-27
TL-40022R	10-27
TL-40023	10-35
TL-40028R	10-27
TL-40042R	10-27
TL-40042Y	10-27
TL-40044	10-33
TL-40048R	10-27
TL-4017	10-29
TL-4018	10-29
TL-40201R	10-31
TL-40201Y	10-31
TL-40202R	10-27
TL-40202Y	10-27
TL-40206R	10-27

TL-40209R	10-27
TL-40215R	10-27
TL-40222R	10-27
TL-40242R	10-28
TL-40242Y	10-28
TL-40248R	10-28
TL-40715	10-15
TL-40719	10-15
TL-40720	10-15
TL-40725	10-15
TL-40742	10-30
TL-40743	10-30
TL-40746	10-30
TL-40747	10-30
TL-40756	10-30
TL-40757	10-30
TL-41005R	10-28
TL-41006R	10-28
TL-41007R	10-28
TL-42722	10-17
TL-42722	10-34
TL-44030R	10-28
TL-44032R	10-28
TL-44036R	10-28
TL-44038R	10-28
TL-44302R	10-28
TL-44322R	10-28
TL-44326R	10-28
TL-44328R	10-28
TL-45002R	10-28
TL-45002Y	10-28
TL-45201R	10-28
TL-45201Y	10-28
TL-45202R	10-28
TL-45202Y	10-28
TL-45221Y	10-28
TL-45700	10-17
TL-45720	10-17
TL-50208	10-20
TL-50209	10-20
TL-50250	10-20
TL-50251	10-20
TL-50300	10-20
TL-50301	10-20
TL-50303	10-20
TL-50304	10-20
TL-50308	10-20
TL-50309	10-20
TL-50344	10-21
TL-50345	10-21

TL-50400	9-6
TL-50401	9-6
TL-50805	9-3
TL-50806	9-2
TL-50822	9-3
TL-50831	10-18
TL-50840	9-6
TL-50841	9-6
TL-50842	9-6
TL-50845	9-6
TL-50846	9-6
TL-50850	9-6
TL-50860	9-3
TL-50864	9-2
TL-50865	9-2
TL-50882	9-5
TL-50883	9-5
TL-50890	9-14
TL-50899	9-14
TL-50957	9-13
TL-52104-1576	9-13
TL-5315Y101	10-29
TL-5316Y101	10-29
TL-54	10-12
TL-54A	10-12
TL-60002R	10-28
TL-60002Y	10-28
TL-60004C	10-33
TL-60015Y	10-31
TL-60072Y	10-31
TL-60075Y	10-31
TL-60085R	10-31
TL-60201R	10-31
TL-60201Y	10-31
TL-60250R	10-31
TL-60275Y	10-31
TL-60280Y	10-31
TL-60302R	10-28
TL-60315Y	10-31
TL-60403	10-17
TL-60703	10-17
TL-60720	10-17
TL-60722	10-17
TL-60723	10-17
TL-60728	10-17
TL-60730	10-17
TL-70300	10-32
TL-70311	10-28
TL-70356	10-32
TL-70357	10-32

TL-80302R	10-29
TL-80334R	10-29
TL-80335R	10-29
TL-80336R	10-29
TL-80339R	10-29
TL-80340	10-33
TL-80344	10-33
TL-80350	10-35
TL-80351	10-35
TL-80354	10-35
TL-80355	10-35
TL-80360	10-35
TL-80361	10-35
TL-80374	10-35
TL-80388	10-35
TL-80394	10-35
TL-80396	10-35
TL-80397	10-35
TL-82030R	10-29
TL-82031R	10-29
TL-87208	10-21
TL-87804	9-6; 10-21
TL-88547	9-13
TL-88794-0720	9-13
TL-9007	10-37
TL-9007A	10-37
TL-90325Y	10-32
TL-9093	10-37
TL-9093A	10-37
TL-93745	10-19
TL-93906	10-18
TL-93908	10-18
TL-93943	10-18
TL-94706	10-18
TL-94707	10-18
TL-94729	10-18
TL-94789	10-18
TL-94811	10-18
TL-94862	10-19
TL-94922	10-18
TL-94924	10-19
TL-94925	10-19
TL-94926	10-19
TL-94931	10-19
TL-94932	10-19
TL-94940	10-19
TL-94992	10-19
TL-95000	10-19
TL-95407	10-19
TL-96904	10-19

# Index by Part Number



TL-96919	10-19
TL-96930	10-19
TL-96932	10-19
TL-97101	9-14
TL-97232	9-12
TL-97804	12-9
TL-97940	10-38
TL-97944	10-38
TL-97960	17-2
TL-97962	17-2
TL-98001R	10-12
TL-98001Y	10-12
TL-98002R	10-12
TL-98002Y	10-12
TL-98003R	10-12
TL-98003Y	10-12
TL-98005R	10-12
TL-98005Y	10-12
TL-98006R	10-12
TL-98006Y	10-12
TL-98007R	10-12
TL-98007Y	10-12
TL-98008R	10-12
TL-98008Y	10-12
TL-98030R	10-12
TL-98030Y	10-12
TL-98175Y	10-12
TL-99007R	10-37
TL-99039R	10-37
TL-99066Y	10-37
TL-99067R	10-37
TL-99067Y	10-37
TL-99068R	10-37
TL-99077R	10-37
TL-99090R	10-37
TL-99090Y	10-37
TO-29013-15X96	8-40
TO-29014-11.5X96	8-40
TO-29014-11X96	8-40
TO-29014-12X96	8-40
TO-29014-12X96PPW	8-40
TO-29014-13X96	8-40
TO-29014-14X96	8-40
TO-29014-15X96	8-40
TO-29014-15X96PPW	8-40
TO-29014-18X96	8-40
TO-29016-11X90	8-41
TO-29016-11X96	8-41
TO-29016-12X90	8-41
TO-29016-12X96	8-41

TO-29016-12X96PPW	8-41
TO-29016-13X90	8-41
TO-29016-13X96	8-41
TO-29016-14X96	8-41
TO-29016-15X90	8-41
TO-29016-15X90PPW	8-41
TO-29016-15X96	8-41
TO-29016-15X96PPW	8-41
TO-29016-16X96	8-41
TO-29016-18X96	8-41
TO-29018-11X96	8-40
TO-29018-12X96	8-40
TO-29018-13X96	8-40
TO-29018-15X90	8-40
TO-29018-15X96	8-40
TO-29020-11X96	8-41
TO-29020-12X96	8-41
TO-29020-13X96	8-41
TO-29020-15X96	8-41
TO-29889-16X98	8-40
TO-29890-2-16X96ABF	8-41
TO-39000-1012	16-1
TO-39000-1016	16-1
TO-39582	8-47
TO-49014	8-39
TO-49014-1	8-43
TO-49014-2	8-43
TO-49101-1	8-44
TO-49101-2	8-44
TO-49406-1	8-43/44
TO-49406-2	8-43/44
TO-49702	8-39
TO-49702-1	8-43/44
TO-49702-2	8-43/44
TO-49895-5	8-43/44
TO-49895-6	8-43/44
TO-50035	8-39
TO-51036-1	8-43
TO-51036-2	8-43
TO-51037	8-43
TO-51037	8-48
TO-51038	8-43/48
TO-51042-40	8-45
TO-51043	8-43
TO-51044	8-43/47
TO-51065	8-43
TO-51079-1	8-47
TO-51079-2	8-47
TO-59003	8-43/47
TO-59004	8-43/47

TO-59129-1	8-43
TO-59129-2	8-43
TO-59157-3	8-43
TO-59157-4	8-43
TO-59158	8-43
TO-59206	8-45
TO-59220	8-45
TO-59292	8-39/45/48
TO-59293	8-45
TO-61026	8-43/48
TO-61191	8-41/43/48
TO-61196	8-43/48
TO-61204	8-41/43/48
TO-61223	8-48
TO-61229	8-48
TO-61352	8-43/48
TO-61355	8-46
TO-61390	8-43
TO-61401	8-41/43/48
TO-61402	8-43
TO-61403	8-43/48
TO-69020S	8-46/48
TO-69035	8-43/48
TO-69265	8-46
TO-69341	8-43
TO-69431	8-43
TO-69432	8-43/48
TO-69433	8-46/48
TO-69571	8-43/47/48
TO-69572	8-43/46/48
TO-69691	8-46
TO-69718	8-45
TO-69790	8-45
TO-69807	8-47
TO-69832-NS	8-43
TO-69840	8-45
TO-69922	8-45
TO-69964-1	8-46
TO-69964-2	8-46
TO-69986-1	8-46
TO-69986-2	8-46
TO-69987	8-46
TO-69988	8-46
TO-70223	8-47
TO-70236	8-43
TO-70238	8-43
TO-70305	8-47
TO-70311	8-46
TO-70317-1	8-43
TO-70317-1	8-47

TO-70317-2	8-47
TO-70337	8-45
TO-70338	8-45
TO-70374	8-4
TO-80015-0040	8-60
TO-80015-0052	8-60
TO-80015-0096	8-60
TO-80020	8-43
TO-80401-316	8-43
TO-80701-2	8-43
TO-80840-1	8-41/43/48
TO-80844-16	8-43
TO-89049	8-43
TO-89210-0032	8-43/48/60
TO-89210-0036	8-43/48/60
TO-89210-0040	8-60
TO-89210-0044	8-60
TO-93494-A	8-46
TO-99030-3	8-45
TO-99610-1	8-39
TO-99610-1-PPW	8-39
TO-99610-2	8-39
TO-99610-2-PPW	8-39
TO-99611-1	8-39
TO-99611-1-PPW	8-39
TO-99611-2	8-39
TO-99611-2-PPW	8-39
TO-99836-1	8-39
TO-99836-2	8-39
TO-99837-1	8-39
TO-99837-1-PPW	8-39
TO-99837-2	8-39
TO-99837-2-PPW	8-39
TO-99ABF1-4	8-39
TS-64009S	1-22
TS-65060U	1-21
TS-65156U	1-21
TS-65262U	1-21
TS-69697	1-21
TS-69699	1-21
TS-70561	1-21
TS-70596	1-21
TS-70598	1-21
TS-70799	1-21
TV-500	2-13
TV-501	2-13
TV-510	2-13
TV-511	2-13
TV-543D	2-13
TV-544D	2-13

TV-571A	2-13
TV-A-100-VC-1	2-13
TV-A-100-VC-3	2-13
TV-A-100-VC-8	2-13
TV-G-170	2-13
TV-G-172	2-13
TV-HE-392	2-13
UB-AX4411	10-40
UB-BM1040B	10-41
UB-GR2000	10-40
UB-GR2001	10-40
UB-GR2238	10-40
UB-GR4000	10-40
UB-LED1040A	10-39
UB-LED1040R	10-39
UB-LED1225A	10-39
UB-LED1225R	10-39
UB-LED2000A	10-39
UB-LED2000R	10-39
UB-LED2238A	10-40
UB-LED2238R	10-40
UB-LED2500A	10-39
UB-LED2500R	10-39
UB-LED4000A	10-40
UB-LED4000R	10-40
UB-LP1002	10-40
UB-MLR2040A	10-39
UB-MLR2040R	10-39
UB-PT6020	10-41
UB-PT9530	10-41
UB-SE1040A	10-39
UB-SE1040R	10-39
UB-SE1225A	10-39
UB-SE1225C	10-39
UB-SE1225R	10-39
UB-SE2000A	10-39
UB-SE2000R	10-39
UB-SE2238A	10-40
UB-SE2238R	10-40
UB-SE2500A	10-39
UB-SE2500R	10-39
UB-SE4000A	10-40
UB-SE4000R	10-40
UB-SE4000W	10-40
UB-SR2500A	10-39
UB-SR2500R	10-39
UB-TM8050L	10-41
UB-TM8050R	10-41
UT-BR02-628	7-19
UT-BR03-625	7-19

UT-CM01	7-47
UT-CM02	7-47
UT-HG01	8-17
UT-NR01	7-3
UT-RP01	7-11
UT-RP02	7-11
UT-SP01	7-25
UT-SP02	7-25
UT-SS01	7-29
UT-SS02	7-29
UT-SS03	7-29
UT-TR02-628	7-16
UT-TR03-625	7-16
VR-325614-012	1-23
VR-325614-101	1-23
VR-777717-475	1-24
VR-777717-490	1-24
VR-777717-494	1-24
VR-777717-500	1-24
VR-777717-510	1-24
VR-777717-514	1-24
VR-777717-520	1-24
VR-777717-525	1-24
VR-777717-572	1-24
VR-777717-676	1-24
WA-BR02-626	7-20
WA-BR04-626	7-20
WA-HB01	8-19
WA-RB01	7-38
WA-RP01	7-9
WA-RP02	7-9
WA-SP01	7-25
WA-SP03	7-26
WA-TR01-624	7-16
WA-TR03-626	7-16
WB-10019--N	2-4
WB-10209--N	2-3
WB-1320Z--N	2-3
WB-1331Z--N	2-4
WB-20231--5	2-3
WB-20231--5T	2-3
WB-20231UH5	2-2
WB-20231UQML	2-2
WB-20231UQMR	2-2
WB-23231--3	2-3
WB-23231--5T	2-3
WB-3314	2-10
WB-3320	2-10
WB-3322	2-10
WB-5580Z--A	2-1

# Index by Part Number



WB-5682Z--A	2-1
WB-60876	2-5
WB-61527B	2-6
WB-61528B	2-6
WB-62200	2-5
WB-62240	2-7
WB-62997	2-6
WB-63631	2-5
WB-63637	2-7
WB-63647	2-7
WB-63680	2-7
WB-65167B	2-6
WB-65541B	2-6
WB-66353	2-5
WB-66812	2-5
WB-66815	2-5
WB-66864	2-5
WB-66864B	2-5
WB-66873	2-5
WB-66875	2-5
WB-66884	2-5
WB-66884B	2-5
WB-66892	2-6
WB-66893	2-5
WB-66895B	2-6
WB-67518	2-7
WB-68730	2-7
WB-68765	2-7
WB-68891	2-5
WB-68897	2-7
WB-68981B	2-6
WB-68981B	2-7
WB-70159--A	2-1
WB-75209--A	2-1
WB-75209GCA	2-2
WB-76229--M	2-1
WB-83153--A	2-1
WB-85203--A	2-1
WB-85223--A	2-1
WE-10-00011-001	2-3
WE-10-00011-101	2-3
WE-10-00011-103	2-3
WE-10-00011-104	2-3
WE-10-00011-105	2-3
WE-10-00011-106	2-3
WH-1002-3	8-60
WH-1002-36	8-60
WH-10-1002-11	8-51/60
WH-10-1002-3	8-51/60
WH-10-1002-36	8-60

WH-10-1002-4	8-60
WH-10-1002-9	8-51/60
WH-10-1003-2	8-60
WH-10-1003-8	8-60
WH-10-1009-8	8-51
WH-1021	8-51
WH-1031	8-51
WH-11	8-49
WH-1-1	8-51/59
WH-1-11	8-59
WH-11-2	8-51
WH-112-1	8-59
WH-112-3	8-59
WH-11-3	8-51
WH-11-4	8-51
WH-11-5	8-51
WH-1-2	8-51/59
WH-1207	8-51
WH-1208	8-51
WH-1209-A	8-51/60
WH-1264	8-51/60
WH-1336-1	8-57
WH-1336-2	8-57
WH-1370	8-51
WH-1371	8-51
WH-1-4	8-51/59
WH-15	8-51/60
WH-1-7	8-51/59
WH-1715	8-51/60
WH-18-3-90	8-51
WH-18-3-96	8-51
WH-1-9	8-59
WH-2275	8-49
WH-2275-1	8-51
WH-2275-2	8-51
WH-2376	8-49
WH-2376-86.5	8-51
WH-2376-87	8-51/57
WH-2376-93	8-51/57
WH-2376-93-192X32.5	8-57
WH-240-15X96	8-55
WH-242-11X96	8-55
WH-242-12X96	8-55
WH-242-13X96	8-55
WH-242-14X96	8-55
WH-242-15X96	8-55
WH-243-12X96	8-56
WH-243-15X96	8-56
WH-245-15X90	8-56
WH-245-15X90-LS CUT	8-56

WH-245-15X96	8-56
WH-245-15X96-LS CUT	8-56
WH-246-11X96	8-56
WH-246-12X96	8-56
WH-246-13X96	8-56
WH-246-15X90	8-56
WH-246-15X96	8-56
WH-248-12X90	8-56
WH-248-12X96	8-56
WH-248-15X90	8-56
WH-248-15X96	8-56
WH-2518	8-51
WH-2523	8-51
WH-2524	8-51
WH-2525	8-51
WH-2526	8-51
WH-2547	8-51
WH-2548	8-51
WH-2694	8-58
WH-2804	8-51
WH-2996	8-51/59
WH-3228	8-51/59
WH-340-18x96	8-55
WH-342-11.5X96	8-55
WH-342-11X96	8-55
WH-342-12X96	8-55
WH-342-13X96	8-55
WH-342-14X96	8-55
WH-342-15X96	8-55
WH-343-11.5X96	8-56
WH-343-15.5X96	8-56
WH-343-15X96	8-56
WH-345-3-11X96	8-56
WH-345-3-12X90	8-56
WH-345-3-12X96	8-56
WH-345-3-13X90	8-56
WH-345-3-13X96	8-56
WH-345-3-15X90	8-56
WH-345-3-15X96	8-56
WH-346-11.5X96	8-56
WH-353-12X96	8-56
WH-353-15X96	8-56
WH-3765	8-57
WH-3766	8-57
WH-4024	8-58
WH-4032	8-51
WH-5423	8-51
WH-5464-96	8-57
WH-5726	8-58
WH-5735	8-51

WH-5803	8-58
WH-58A-1	8-4
WH-58CF-20	8-4
WH-58R-12-14	8-4
WH-58R-12-9	8-4
WH-58R-16-14	8-4
WH-58R-16-9	8-4
WH-58R-20-14	8-4
WH-58R-20-9	8-4
WH-58R-24-14	8-4
WH-58R-24-9	8-4
WH-58R-8-14	8-4
WH-58S-1	8-4
WH-58T-1	8-4
WH-58T-3	8-4
WH-59	8-58
WH-6	8-51
WH-6943	8-51/60
WH-6944	8-51/60
WH-70	8-58
WH-70-10	8-57
WH-70-13	8-51/57
WH-70-19	8-57
WH-70-300	8-58
WH-70-5	8-57
WH-7176-92	8-57
WH-7470	8-57
WH-75	8-58
WH-75-10	8-58
WH-7515	8-51/58/60
WH-77	8-51/58/60
WH-77-1	8-58
WH-7905	8-57
WH-8280-90	8-51
WH-8280-96	8-51
WH-83	8-51
WH-85	8-58
WH-90X100C	8-49
WH-90X100C-PPW	8-49
WH-90X100LTO	8-49
WH-90X100LTO-PPW	8-49
WH-90X90C	8-49
WH-90X90LTO	8-49
WH-96X100C	8-49
WH-96X100LTO	8-49
WH-96X107C	8-49
WH-96X107LTO	8-49
WH-9723	8-51/57
WH-9723-1	8-51/57
WH-9723-2	8-51/57

WH-98X107C	8-49
WH-98X107C-PPW	8-49
WH-98X107LTO	8-49
WH-98X107LTO-PPW	8-49
WH-GP90X100C	8-54
WH-GP90X100LTO	8-54
WH-GP90X90C	8-54
WH-GP90X90LTO	8-54
WH-GP96X100C	8-54
WH-GP96X100LTO	8-54
WH-GP96X107C	8-54
WH-GP96X107LTO	8-54
WT-1346	3-4
WT-1360X10	3-15
WT-1360X4	3-15
WT-1360X6	3-15
WT-1360X8	3-15
WT-1361X4	3-15
WT-1361X6	3-15
WT-1361X8	3-15
WT-1362X10	3-14
WT-1362X4	3-14
WT-1362X6	3-14
WT-1362X8	3-14
WT-1364X6	3-14
WT-1364X8	3-14
WT-1368X10Z	3-15
WT-1368X4X4Z	3-15
WT-1368X4Z	3-15
WT-1368X6X2Z	3-15
WT-1368X6X6Z	3-15
WT-1368X6X8Z	3-15
WT-1368X6Z	3-15
WT-1368X8X4Z	3-15
WT-1368X8Z	3-15
WT-1369X4X4Z	3-15
WT-1369X4Z	3-15
WT-1369X6X2Z	3-15
WT-1369X6X6Z	3-15
WT-1369X6Z	3-15
WT-1369X8X4Z	3-15
WT-1369X8Z	3-15
WT-145	3-11
WT-1460X4	3-14
WT-1460X6	3-14
WT-1460X8	3-14
WT-1461X4	3-14
WT-1461X6	3-14
WT-1461X8	3-14
WT-1462X10	3-12

WT-1462X4	3-12
WT-1462X6	3-12
WT-1462X8	3-12
WT-1464X4	3-12
WT-1464X6	3-12
WT-1464X8	3-12
WT-1468X4X4Z	3-13
WT-1468X4Z	3-13
WT-1468X6X2Z	3-13
WT-1468X6X6Z	3-13
WT-1468X6X8Z	3-13
WT-1468X6Z	3-13
WT-1468X8X4Z	3-13
WT-1468X8X8Z	3-13
WT-1468X8Z	3-13
WT-1469X4X4Z	3-13
WT-1469X4Z	3-13
WT-1469X6X2Z	3-13
WT-1469X6X6Z	3-13
WT-1469X6X8Z	3-13
WT-1469X6Z	3-13
WT-1469X8X4Z	3-13
WT-1469X8X8Z	3-13
WT-1469X8Z	3-13
WT-1472X4Z	3-13/15
WT-1472X6X6X6Z	3-13/15
WT-1472X6Z	3-13/15
WT-1472X8Z	3-13
WT-1480X6Z	3-13
WT-1480X8Z	3-13
WT-1480XX6X6Z	3-13
WT-1484X10	3-14
WT-1484X4	3-14
WT-1484X6	3-14
WT-1484X8	3-14
WT-2030X44	3-14
WT-2030X6	3-14
WT-2030X8	3-14
WT-3151X6	3-16
WT-3151X8	3-16
WT-3152X2	3-16
WT-3152X4	3-16
WT-3152X6	3-16
WT-3152X8	3-16
WT-3200X6X4	3-17
WT-3200X8X6	3-17
WT-3220X12X8	3-16
WT-3220X4X2	3-16
WT-3220X6X2	3-16
WT-3220X6X4	3-16



# Index by Part Number



WT-3220X8X4	3-16
WT-3220X8X6	3-16
WT-3300X2	3-16
WT-3300X4	3-16
WT-3300X6	3-16
WT-3300X6X4	3-16
WT-3300X8	3-16
WT-3325X4	3-17
WT-3325X6	3-17
WT-3326X2	3-17
WT-3326X4	3-17
WT-3326X6	3-17
WT-3326X8	3-17
WT-3328X6	3-16
WT-3328X8	3-16
WT-3350X6	3-17
WT-33806A	3-12
WT-33806B	3-12
WT-33806B-Y06	3-12
WT-33806B-Y24	3-12
WT-33806B-Y26	3-12
WT-33806B-Y28	3-12
WT-33806B-Y34	3-12
WT-33806B-Y36	3-12
WT-33806B-Y38	3-12
WT-33808A	3-12
WT-33808B-Y08	3-12
WT-33808B-Y26	3-12
WT-33808B-Y28	3-12
WT-33808B-Y36	3-12
WT-33808B-Y38	3-12
WT-3400X2	3-17
WT-3400X4	3-17
WT-3400X6	3-17
WT-3400X8	3-17
WT-3500X4	3-17
WT-3500X6	3-17
WT-3700X2	3-17
WT-3700X4	3-17
WT-3700X6	3-17
WT-3750X4	3-17
WT-C3069X8	3-22
WT-W15310	3-11



# About Trailmobile Part Numbers

A

We create our own part number if the product is not known in the industry under the Supplier's part number.

For example, we use 50-18M-20 for a 1/4" X 7/16" aluminum modified brazier head rivet.

Or we assign a two-letter prefix to a Supplier's part number if the product is known in the industry under the Supplier's part number.

For example, Truck-Lite's 10202R becomes TL-10202R.

We also use the two-letter prefix to group certain products together.

For example, drill bits (DB-) and light bulbs (LB-), generic air valves (AV-), generic replacements for Todco (GT-) and Whiting (GW-), or will-fit replacement parts for other makes of trailers: Dorsey (DO-), Fruehauf (FR-), Great Dane (GD-), Lufkin (LU-), Stoughton (SO-), Utility (UT-), and Wabash (WA-) among others.

---

Turn the page for two listings.

The first listing is sorted by the two-letter prefix.

The second listing is sorted by Supplier.

# About Trailmobile Part Numbers



3M-	3M
AC-	Accuride
AL-	Alcoa
AV-	Generic Air Valves
BC-	Buyers Products
BE-	Betts
BG-	General Bearing
BK-	Binkley
BP-	Butler Products
BX-	Bendix
CB-	Crewson Bruner/Protier
CL-	Cleanco/Harper Brush
CM-	Columbus McKinnon
CP-	Chicago Pneumatic
CR-	Chicago Rawhide/SKF
CT-	Camcar/Textron
DA-	Dana
DB-	Champion Drill Bits
DO-	Replaces Dorsey
DW-	Dayton Walther/Meritor
FL-	Fleetline
FP-	Florida Pneumatic
FR-	Replaces Fruehauf
FS-	Firestone
GB-	Gabriel
GD-	Replaces Great Dane
GL-	Gloves
GR-	Grote
GT-	Generic Todco
GU-	Gunite
GW-	Generic Whiting
HA-	Haldex
HL-	Holland
HP-	Replaces Monon
HT-	Hendrickson Turner
HU-	Hutch
HY-	Hyco
JK-	James King
JO-	Jost
KI-	Kinedyne
KL-	Kemlite
KW-	Austin-Westran
LM-	Labelmaster
LT-	Loctite/Permatex
LU-	Replaces Lufkin
MA-	Manus
MG-	MGM Brakes
MI-	Midland/Haldex
MN-	Miner/Powerbrace
MP-	Morgan
MW-	Motorwheel/Hayes Lemmerz
NA-	National
NE-	Neway
PH-	Phillips
PI-	Replaces Pines
PM-	Peterson

PP-	Shell
PZ-	Penz
QC-	Quality Chain
RG-	Road Gear
RI-	Ridewell
RW-	Meritor
RY-	Reyco/Tuthill
SL-	Sealco
SM-	Stemco
SO-	Replaces Stoughton
SS-	Signal Stat/Truck-Lite
ST-	Replaces Strick
TA-	Torx Bits & Adapters
TB-	Trico
TK-	Timken
TL-	Truck-Lite
TO-	Todco
TS-	Triseal
TV-	Tire Valves
UB-	Uni-Bond
UT-	Replaces Utility
VR-	Veeder-Root
WA-	Replaces Wabash
WB-	Webb
WE-	Walther Engineering
WH-	Whiting
WT-	Weatherhead

Grote	GR-
Gunite	GU-
Haldex	HA-
Hendrickson Turner	HT-
Holland	HL-
Hutch	HU-
Hyco	HY-
James King	JK-
Jost	JO-
Kemlite	KL-
Kinedyne	KI-
Labelmaster	LM-
Loctite/Permatex	LT-
Manus	MA-
Meritor	RW-
MGM Brakes	MG-
Midland/Haldex	MI-
Miner/Powerbrace	MN-
Morgan	MP-
Motorwheel/Hayes Lemmerz	MW-
National	NA-
Neway	NE-
Penz	PZ-
Peterson	PM-
Phillips	PH-
Quality Chain	QC-
Replaces Dorsey	DO-
Replaces Fruehauf	FR-
Replaces Great Dane	GD-
Replaces Lufkin	LU-
Replaces Monon	HP-
Replaces Pines	PI-
Replaces Stoughton	SO-
Replaces Strick	ST-
Replaces Utility	UT-
Replaces Wabash	WA-
Reyco/Tuthill	RY-
Ridewell	RI-
Road Gear	RG-
Sealco	SL-
Shell	PP-
Signal Stat/Truck-Lite	SS-
Stemco	SM-
Timken	TK-
Tire Valves	TV-
Todco	TO-
Torx Bits & Adapters	TA-
Trico	TB-
Triseal	TS-
Truck-Lite	TL-
Uni-Bond	UB-
Veeder-Root	VR-
Walther Engineering	WE-
Weatherhead	WT-
Webb	WB-
Whiting	WH-

3M	3M-
Accuride	AC-
Alcoa	AL-
Austin-Westran	KW-
Bendix	BX-
Betts	BE-
Binkley	BK-
Butler Products	BP-
Buyers Products	BC-
Camcar/Textron	CT-
Champion Drill Bits	DB-
Chicago Pneumatic	CP-
Chicago Rawhide/SKF	CR-
Cleanco/Harper Brush	CL-
Columbus McKinnon	CM-
Crewson Bruner/Protier	CB-
Dana	DA-
Dayton Walther/Meritor	DW-
Firestone	FS-
Fleetline	FL-
Florida Pneumatic	FP-
Gabriel	GB-
General Bearing	BG-
Generic Air Valves	AV-
Generic Todco	GT-
Generic Whiting	GW-
Gloves	GL-

# Axles and Components

---

<b>MERITOR AXLES</b> .....	<b>1-1</b>
<b>DANA SPICER AXLES</b> .....	<b>1-1</b>
<b>AXLE ASSEMBLIES</b> .....	<b>1-2</b>
<b>BRAKE SHOES</b> .....	<b>1-3</b>
<b>BRAKE SHOE REPAIR KITS</b> .....	<b>1-4 TO 1-6</b>
<b>BRAKE SPIDER</b> .....	<b>1-6</b>
<b>BRAKE SHOE HARDWARE</b> .....	<b>1-7</b>
<b>BRAKE CAM SHAFTS</b> .....	<b>1-8 TO 1-10</b>
<b>CAM SHAFT REPAIR KITS</b> .....	<b>1-11 TO 1-12</b>
<b>CAM SHAFT BUSHINGS &amp; SUPPORT BRACKETS</b> .....	<b>1-13</b>
<b>CAM SHAFT WASHERS, LOCK RINGS, &amp; SEALS</b> .....	<b>1-14</b>
<b>MANUAL SLACK ADJUSTERS</b> .....	<b>1-15</b>
<b>AUTOMATIC SLACK ADJUSTERS</b> .....	<b>1-15 TO 1-17</b>
<b>DUST SHIELDS</b> .....	<b>1-17</b>
<b>AXLE NUTS &amp; WASHERS</b> .....	<b>1-18</b>
<b>BEARINGS &amp; RACES</b> .....	<b>1-19</b>
<b>OIL SEAL INTERCHANGE</b> .....	<b>1-20</b>
<b>OIL SEALS</b> .....	<b>1-21</b>
<b>STEMCO HUB CAPS, GASKETS, WINDOW KITS, &amp; VENT PLUGS</b> .....	<b>1-21</b>
<b>MISC. HUB CAPS, GASKETS, &amp; VENT PLUGS</b> .....	<b>1-22</b>
<b>HUBODOMETER MOUNTING BRACKETS</b> .....	<b>1-23</b>
<b>HUBODOMETERS</b> .....	<b>1-24</b>

# 5-inch Round Axles



## Meritor

Part Number	Track	Bearing Combination		Wall Thickness	Brake Size	Capacity	Cam Length	Cam Shaft 28 Tooth	Cam Bushing Kit
		Inner	Outer						
RW-TN4671QR1150	71-1/2"	HM218248	HM212049	1/2"	16-1/2" X 7"	22,500#	17-5/16"	700-7-272 (R.H.) 700-7-273 (L.H.)	700-7-286
RW-TQ4671QR1350	71-1/2"	HM218248	HM212049	5/8"	16-1/2" X 7"	25,000#	24-1/16"	700-7-274 (R.H.) 700-7-275 (L.H.)	700-7-286
RW-TP4671QR1250	71-1/2"	HM518445	HM518445	1/2"	16-1/2" X 7"	22,500#	17-5/16"	700-7-272 (R.H.) 700-7-273 (L.H.)	700-7-286
RW-TN4671QR7150	77-1/2"	HM218248	HM212049	1/2"	16-1/2" X 7"	22,500#	17-5/16"	700-7-272 (R.H.) 700-7-273 (L.H.)	700-7-286
RW-TN4671LR7250	77-1/2"	HM218248	HM212049	1/2"	16-1/2" X 7" Q Plus	22,500#	17-5/16"	700-7-272 (R.H.) 700-7-273 (L.H.)	700-7-286
RW-TQ4671QR7350	77-1/2"	HM218248	HM212049	5/8"	16-1/2" X 7"	25,000#	24-1/16"	700-7-274 (R.H.) 700-7-275 (L.H.)	700-7-286
RW-TQ4671LR7350	77-1/2"	HM218248	HM212049	5/8"	16-1/2" X 7" Q Plus	25,000#	24-1/16"	700-7-274 (R.H.) 700-7-275 (L.H.)	700-7-286
RW-TP4671QR7150	77-1/2"	HM518445	HM518445	1/2"	16-1/2" X 7"	22,500#	17-5/16"	700-7-272 (R.H.) 700-7-273 (L.H.)	700-7-286
RW-TP8671QR7350	77-1/2"	HM518445	HM518445	5/8"	16-1/2" X 7"	25,000#	24-1/16"	700-7-274 (R.H.) 700-7-275 (L.H.)	700-7-286

## Dana Spicer

Part Number	Track	Bearing Combination		Wall Thickness	Brake Size	Capacity	Cam Length	Cam Shaft 28 Tooth	Cam Bushing Kit
		Inner	Outer						
DA-D22AX503A624	71-1/2"	HM218248	HM212049	1/2"	16-1/2" X 7"	22,500#	17-3/8"	M16WKR25-175 (R.H.) M16WKL25-175 (L.H.)	DA-M10KY105
DA-D22AX603A1275	71-1/2"	HM218248	HM212049	5/8"	16-1/2" X 7"	25,000#	23-3/4"	700-7-298 (R.H.) 700-7-297 (L.H.)	DA-M10KY105
DA-D22AX6031500	71-1/2"	HM218248	HM212049	5/8"	12-1/4" X 7-1/2"	25,000#	23-1/8"	M12WKR25-233 (R.H.) M12WKL25-233 (L.H.)	DA-M10KY105
DA-D21AX50354	71-1/2"	663	HM212049	7/16"	16-1/2" X 7"	22,500#	20-7/16"	700-7-296 (R.H.) 700-7-295 (L.H.)	DA-M10KY105
DA-D22AX503A1279	77-1/2"	HM218248	HM212049	1/2"	16-1/2" X 7"	22,500#	17-3/8"	M16WKR25-175 (R.H.) M16WKL25-175 (L.H.)	DA-M10KY105
DA-D22AX603A1276	77-1/2"	HM218248	HM212049	5/8"	16-1/2" X 7"	25,000#	23-3/4"	700-7-298 (R.H.) 700-7-297 (L.H.)	DA-M10KY105

# 5-inch Round Axle Assemblies



## Hub Piloted

Part Number	Track	Axle	Hub	Drum	ABS Ready
700-60-29	71-1/2"	RW-TN4671QR1150	DW-04-15571-001	DW-03-123207	Yes
700-60-29-1	77-1/2"	RW-TN4671QR7150	DW-04-15571-001	DW-03-123207	Yes
700-60-30	71-1/2"	RW-TQ4671QR1350	DW-04-15571-001	DW-03-123207	Yes
700-60-30-1	77-1/2"	RW-TQ4671QR7350	DW-04-15571-001	DW-03-123207	Yes
Above axle assemblies include: Hub Pilot Hub and Drum Assemblies					
6-Hole Hub Caps and Bolts					
Inner and Outer Bearing Cones					
Oil Seals					

## Stud Piloted

Part Number	Track	Axle	Hub	Drum	ABS Ready
700-60-12	71-1/2"	RW-TN4671QR1150	DW-04-15501-001	DW-03-123207	No
700-60-12-1	77-1/2"	RW-TN4671QR7150	DW-04-15501-001	DW-03-123207	No
700-60-28	71-1/2"	RW-TQ4671QR1350	DW-04-15501-001	DW-03-123207	No
700-60-28-1	77-1/2"	RW-TQ4671QR7350	DW-04-15501-001	DW-03-123207	No
Above axle assemblies include: Stud Pilot Outboard Hub and Drum Assemblies					
6-Hole Hub Caps and Bolts					
Inner and Outer Bearing Cones					
Oil Seals					

# Pressed Steel Brake Shoes

## Eaton-type Unlined Shoe



Part No.	Brake Size	Block No.	Type Shoe
7-A3-128	16-1/2" X 7"	4311G 1/4" Dia. Holes	Quick Change

## Fruehauf-type Unlined Shoe



Part No.	Brake Size	Block No.	Type Shoe
7-A3-132	16-1/2" X 7"	4515 1/4" Dia. Holes	3rd Design

## Meritor-type Unlined Shoe



Part No.	Brake Size	Block No.	Type Shoe
7-A3-127	16-1/2" X 7"	4515 1/4" Dia. Holes	Quick Change

## Meritor-type Lined Shoe

Part No.	Brake Size	Type Lining	Type Shoe
CA-TM4515QSP	16-1/2" X 7"	Carlisle MB 21	Quick Change
Edge code on brake lining is Trailmobile private label			



# Brake Shoe Repair Kits

## 16-1/2" Q SERIES BRAKES

### Standard

**700-7-235**  
with knurled rollers

**RW-KIT8000**

These kits can replace  
Euclid E-2769S



Item	Qty	Part No.	Description
1	2	KC1022	Anchor Pin
2	2	KC1012K	Knurled Roller
3	2	KC1062	Stainless Steel Bushing
4	2	KC1032	Retainer Spring
5	2	KC1052Q	Roller Retainer
6	2	KC1072	Spring Pin
7	1	KC1041	Standard Return Spring

### Heavy Duty

**700-7-239**  
with knurled rollers

This kit can replace  
Euclid E-2769SHD



Item	Qty	Part No.	Description
1	2	KC1022	Anchor Pin
2	2	KC1012K	Knurled Roller
3	2	KC1062	Stainless Steel Bushing
4	2	KC1032	Retainer Spring
5	2	KC1052Q	Roller Retainer
6	2	KC1072	Spring Pin
7	1	KC1241-375	Heavy Duty Return Spring

**700-7-257**  
with knurled rollers  
(Also as 700-7-257-BAG)

This kit can replace  
Euclid E-6999SHD

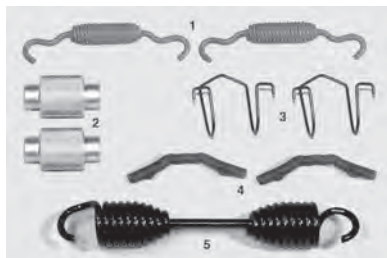

Item	Qty	Part No.	Description
1	2	KC1032	Retainer Spring
2	2	KC1012K	Knurled Roller
3	2	KC1052Q	Roller Retainer
4	2	KC1072	Spring Pin
5	1	KC1241	Heavy Duty Return Spring

**700-7-262**  
with knurled rollers

This kit can replace  
Euclid E-6999SHD

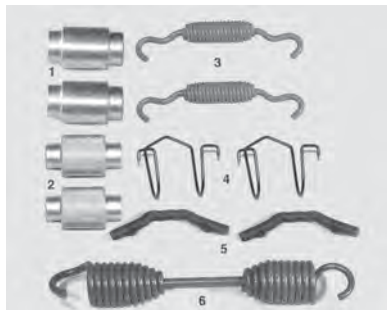

Item	Qty	Part No.	Description
1	2	KC1022	Anchor Pin
2	2	KC1012K	Knurled Roller
3	2	KC1032	Retainer Spring
4	2	KC1052Q	Roller Retainer
5	2	KC1072	Spring Pin
6	1	KC1241-375	Heavy Duty Return Spring

**700-7-263**  
with knurled rollers

This kit can replace  
Euclid E-3895SHD

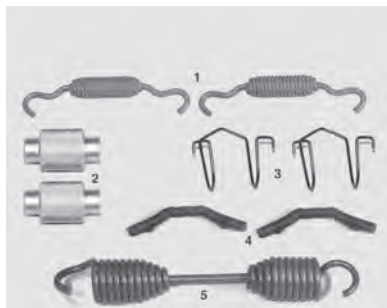

Item	Qty	Part No.	Description
1	2	KC1032	Retainer Spring
2	2	KC1012K	Knurled Roller
3	2	KC1052Q	Roller Retainer
4	2	KC1072	Spring Pin
5	1	KC1241-375	Heavy Duty Return Spring 8-3/8" Length



# Brake Shoe Repair Kits

## 16-1/2" P SERIES BRAKES

**Heavy Duty**  
700-7-258  
with knurled rollers

This kit can replace  
Euclid E-1816SHD

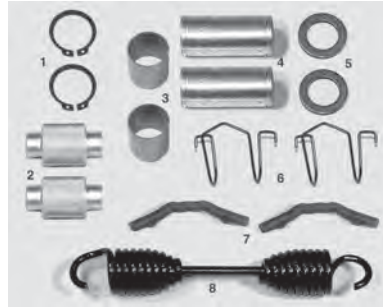

Item	Qty	Part No.	Description
1	4	KC15E4	Lock Ring
2	2	KC1012K	Knurled Roller
3	2	KC1062	Stainless Steel Bushing
4	2	KC1522	Anchor Pin
5	4	KC1584	Washer
6	2	KC1052Q	Roller Retainer
7	2	KC1072	Spring Pin
8	1	KC1541	HD Return Spring 8" Length

## 16-1/2" FRUEHAUF XEM LATE MODEL SERIES

**Standard**  
700-7-259  
with knurled rollers  
(Also as 700-7-259-BAG)

This kit can replace  
Euclid E-3710S

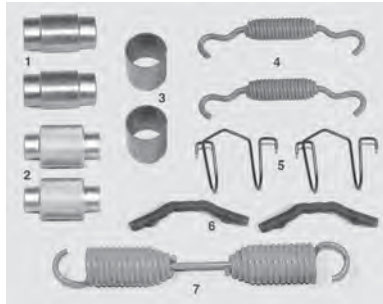

Item	Qty	Part No.	Description
1	2	KC2022	Anchor Pin
2	2	KC1012K	Knurled Roller
3	2	KC1062	Stainless Steel Bushing
4	2	KC1032	Retainer Spring
5	2	KC1052Q	Roller Retainer
6	2	KC1072	Spring Pin
7	1	KC1041	STD Return Spring 8-3/8" Length

**Heavy Duty**  
700-7-238  
with knurled rollers

This kit can replace  
Euclid E-3710SHD

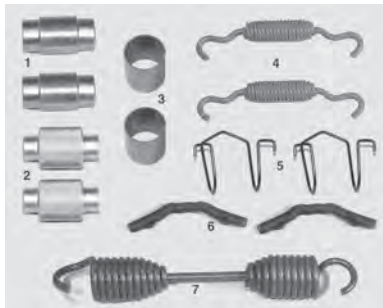

Item	Qty	Part No.	Description
1	2	KC2022	Anchor Pin
2	2	KC1012K	Knurled Roller
3	2	KC1062	Stainless Steel Bushing
4	2	KC1032	Retainer Spring
5	2	KC1052Q	Roller Retainer
6	2	KC1072	Spring Pin
7	1	KC1241-375	HD Return Spring 8-3/8" Length

## 15" FRONT BRAKES

**Q**  
**Standard**  
700-7-305

This kit can replace  
Euclid E-7899

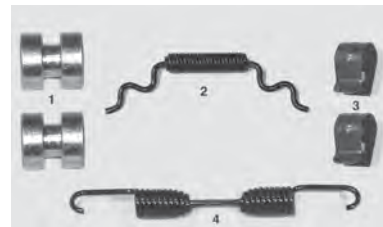

Item	Qty	Part No.	Description
1	2	KC1112	Roller
2	1	KC1131	Retainer Spring
3	2	KC11A2	Shoe Clip
4	1	KC1341	Return Spring 7-11/16" Length

**EATON**  
**Standard**  
700-7-304

This kit can replace  
Euclid E-5139

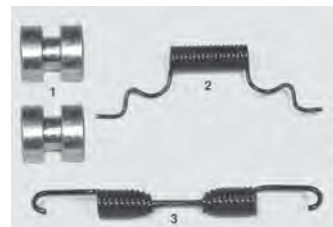

Item	Qty	Part No.	Description
1	2	KC1112	Roller
2	2	KC3131	Retainer Spring
3	1	KC3141	Return Spring 7-1/8" Length

# Brake Shoe Repair Kits

## 16-1/2" EATON

### Heavy Duty

700-7-237

with knurled rollers  
(Also as 700-7-237-BAG)

This kit can replace  
Euclid E-1887ASHD

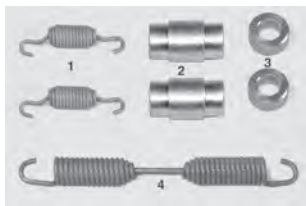

Item	Qty	Part No.	Description
1	2	KC3032	Retainer Spring
2	2	KC3022	Roller Pin
3	2	KC3012K	Knurled Roller
4	1	KC3241	HD Return Spring 10-13/16" Length

## 16-1/2" EATON ES

### Heavy Duty

700-7-306

with knurled rollers

This kit can replace  
Euclid E-5481A

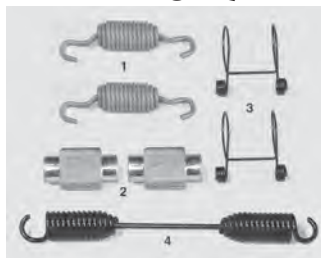

Item	Qty	Part No.	Description
1	2	KC3032	Retainer Spring
2	2	KC3212K	Knurled Roller
3	2	KC3452	Roller Retainer
4	1	KC3441	HD Return Spring 10-3/4" Length

## 16-1/2" EATON ES II

### Heavy Duty

700-7-307

with knurled rollers

This kit can replace  
Euclid E-10244

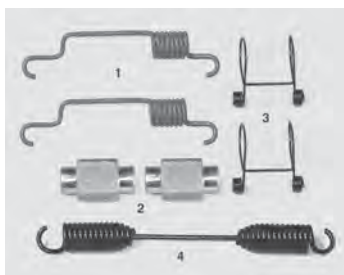

Item	Qty	Part No.	Description
1	2	KC3432	Retainer Spring
2	2	KC3212K	Knurled Roller
3	2	KC3452	Roller Retainer
4	1	KC3441	HD Return Spring 10-3/4" Length

## Brake Spider

### Adjustable Brake Spider

700-7-23

5-3/8" Dia. Pilot Hole

6-5/8" Hole Centers

For 1-2" Studs



Adjustable Anchor Pin Housing.  
Nylon Bushing Installed.











This adjustable brake spider can replace  
Euclid E-957

Meritor A-3211-A-833

Standard Forge 200999-010

# Brake Shoe Hardware

1

	Part No.	O.D.	Length	Replaces	Note
	700-7-206	1-1/4"	2-7/32"	Euclid E-2177	Knurled roller for 16-1/2" brakes with fabricated brake shoes
	700-7-33	1-3/8"	1-29/64"	Euclid E-1893 Meritor 1225-B-496	For use with no-slot anchor pin
	700-7-21	1-1/8"	8"	Euclid E-545A Meritor 2258-P-354	For standard 'P' style brakes
	700-7-142	1-1/8"	8-3/8"	Euclid E-2768 Meritor 2258-U-619	For Spicer 'Fast Change' and Meritor 'Q' brakes
	700-7-141	3/4"	5-1/2"	Euclid E-2767 Meritor 2258-Q-615	For Fruehauf 'XEM' brakes and Meritor 'Q' brakes
	700-7-22			Euclid E-747 Meritor 1218G-85	Used on Meritor, Fruehauf, and Spicer with fabricated brake shoes
	700-7-28			Euclid E-801 Meritor 1229-X-1116	Used on 1-1/4" anchor pins with grooves
	700-7-29			Euclid E-1113 Meritor 1229-B-1848	1-7/8" O.D. ; 1-17/64" I.D.
	700-7-19			Euclid E-539 Meritor 1718-Y-103	Used with new style brake shoe rollers
	700-7-147			Euclid E-3007A Meritor 3105-B-210	Used on Meritor 'Q' brakes

# Brake Cam Shafts

## Cams — S-Head Identification

View from  
Head End

## L.H. — Cams



## R.H. — Cams

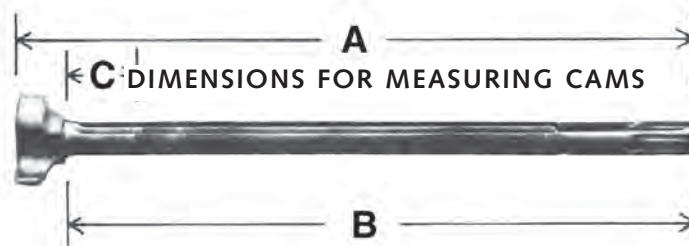

## MULTIPLE USE 1-1/2" 10-SPLINE

Part No.	Overall Length A	Under Head B	To Groove C	Pos.	Replaces	Note
700-7-30	25-15/16"	24"	2-7/32"	R.H.	Meritor 2210-C-6399S Euclid E-4716	
700-7-31	25-15/16"	24"	2-7/32"	L.H.	Meritor 2210-C-6400S Euclid E-4717	
700-7-176	26"	23-3/4"	2-7/32"	R.H.	Eaton 125031 Euclid E-4720	1-1/2" Dia. Spline 1-5/8" Dia. Under Head
700-7-175	26"	23-3/4"	2-7/32"	L.H.	Eaton 125030 Euclid E-4721	
700-7-188	22"	19-1/2"	2-7/32"	R.H.	Eaton 125035 Euclid E-2694	1-1/2" Dia. Spline 1-5/8" Dia. Under Head
700-7-187	22"	19-1/2"	2-7/32"	L.H.	Eaton 125034 Euclid E-2693	
700-17-236	22-7/16	20-3/8"	1-5/8" & 2-7/32"	R.H.	Meritor 2210-E-5413 Euclid E-1424	For Paymaster RL & RN Axles
700-17-237	22-7/16	20-3/8"	1-5/8" & 2-7/32"	L.H.	Meritor 2210-E-5414 Euclid E-1425	
700-17-238	23-1/8"	21-3/32"	2-7/32"	R.H.	Meritor 2210-Z-6318 Euclid E-684	
700-17-239	23-1/8"	21-3/32"	2-7/32"	L.H.	Meritor 2210-A-6319 Euclid E-685	
700-17-243	25-1/8"	23-7/16"	2-5/16"	R.H.	Meritor R607001 Euclid E-1094	Used on Axles with Air Ride Suspensions
700-17-242	25-1/8"	23-7/16"	2-5/16"	L.H.	Meritor R607002 Euclid E-1095	
700-17-244	13-3/4"	11-1/2"	1-3/4"	R.H.	Meritor 2210-C-5359 Euclid E-1147B	Used on Meritor STD TU-267 & 287 Axles
700-17-245	13-3/4"	11-1/2"	1-3/4"	L.H.	Meritor 2210-D-5360 Euclid E-1148B	

# Brake Cam Shafts

## 28-SPLINE 1-1/2" Dia. Spline 1-5/8" Dia. Under Head



Note: Dimension shown is from shoulder of camhead to far edge of lock ring groove.

Part No.	Overall Length A	Under Head B	To Groove C	Pos.	Replaces	Note
7-5-107 See Note Below	19-1/8"	17-5/16"	1-25/32"	R.H.	Meritor 2210-L-4328 Euclid E-2442A	Used on Meritor TN Axles with Spring Suspension
7-5-108 See Note Below	19-1/8"	17-5/16"	1-25/32"	L.H.	Meritor 2210-M-4329 Euclid E-2441A	
7-5-111 See Note Below	22-1/4"	20-13/32"	1-25/32"	R.H.	Meritor 2210-Q-4333 Euclid E-2444A	
7-5-112 See Note Below	22-1/4"	20-13/32"	1-25/32"	L.H.	Meritor 2210-R-4334 Euclid E-2443A	
7-5-113 See Note Below	25-7/8"	24-1/16"	1-25/32"	R.H.	Meritor 2210-N-4330 Euclid E-2446A	Used on Meritor TQ Axles with Air Ride Suspension
7-5-114 See Note Below	25-7/8"	24-1/16"	1-25/32"	L.H.	Meritor 2210-P-4332 Euclid E-2445A	
700-7-272	19-1/8"	17-5/16"	1-25/32" & 2-5/64"	R.H.	Meritor 2210-B-6866 Euclid E-5507	Q Plus Style
700-7-273	19-1/8"	17-5/16"	1-25/32" & 2-5/64"	L.H.	Meritor 2210-C-6867 Euclid E-5506	
700-7-274	25-7/8"	24-1/16"	1-25/32" & 2-5/64"	R.H.	Meritor 2210-D-6868 Euclid E-5511	
700-7-275	25-7/8"	24-1/16"	1-25/32" & 2-5/64"	L.H.	Meritor 2210-E-6869 Euclid E-5510	
700-7-295	22-1/2"	20-7/16"	1-5/8" & 2-7/32"	L.H.	Spicer M16WKL25-205 Euclid E-9733	Used on Axles Serial Number 95J172527 to Current
700-7-296	22-1/2"	20-7/16"	1-5/8" & 2-7/32"	R.H.	Spicer M16WKR25-205 Euclid E-9734	
700-7-297	25-9/16"	23-1/2"	2-7/32"	L.H.	Spicer M16WKL25-236 Euclid E-9735	
700-7-298	25-9/16"	23-1/2"	2-7/32"	R.H.	Spicer M16WKR25-236 Euclid E-9736	
700-7-299	26"	24"	2-7/32"	L.H.	Spicer M16WKL25-242 Euclid E-10909	
700-7-300	26"	24"	2-7/32"	R.H.	Spicer M16WKR25-242 Euclid E-10910	

Note: Cam Shaft part numbers 7-5-107 through 7-5-114 have Q+ style heads. For maximum brake life and performance, these cam shafts should be replaced in pairs.

# Brake Cam Shafts

## 28-SPLINE 1-1/2" Dia. Spline 1-1/2" Dia. Under Head



Note: Dimension shown is from shoulder of camhead to far edge of lock ring groove.

Part No.	Overall Length A	Under Head B	To Groove C	Pos.	Replaces	Note
700-7-282	25-3/8"	23-9/16"	1-5/8" & 2-7/32"	L.H.	Spicer M16WKL20-236 Euclid E-5526	
700-7-283	25-3/8"	23-9/16"	1-5/8" & 2-7/32"	R.H.	Spicer M16WKR20-236 Euclid E-5527	
700-7-289	26-1/8"	24-1/16"	1-5/8" & 2-7/32"	L.H.	Spicer M16WKL20-242 Euclid E-9100	
700-7-290	26-1/8"	24-1/16"	1-5/8" & 2-7/32"	R.H.	Spicer M16WKR20-242 Euclid E-9101	
700-7-293	22-1/2"	20-7/16"	1-5/8" & 2-7/32"	L.H.	Spicer M16WKL20-205 Euclid E-5524	
700-7-294	22-1/2"	20-7/16"	1-5/8" & 2-7/32"	R.H.	Spicer M16WKR20-205 Euclid E-5525	

## 28-SPLINE 1-19/32" Dia. Spline 1-5/8" Dia. Under Head



Note: Dimension shown is from shoulder of camhead to far edge of lock ring groove.

Part No.	Overall Length A	Under Head B	To Groove C	Pos.	Replaces	Note
700-7-291	18-1/8"	16-1/8"	2-5/32"	L.H.	Fruehauf APA-0998-1 Euclid E-9761	Used on Pro-Par Axles
700-7-292	18-1/8"	16-1/8"	2-5/32"	R.H.	Fruehauf APA-0998-2 Euclid E-9762	

## 37-SPLINE 1-19/32" Dia. Spline 1-5/8" Dia. Under Head

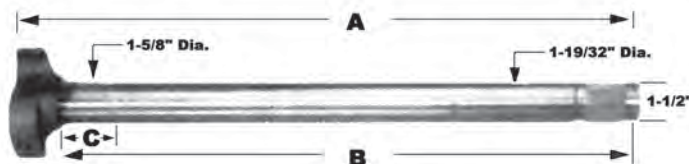

Part No.	Overall Length A	Under Head B	To Groove C	Pos.	Replaces	Note
700-17-247	18-1/8"	16-1/8"	2-5/32"	R.H.	Fruehauf AXA-0420-2 Euclid E-1564	Used on Pro-Par Axles
700-17-246	18-1/8"	16-1/8"	2-5/32"	L.H.	Fruehauf AXA-0420-1 Euclid E-1563	
700-17-332	22-7/8"	21-1/8"	2-5/32"	R.H.	Fruehauf AXA-0420-4 Euclid E-2100	
700-17-333	22-7/8"	21-1/8"	2-5/32"	L.H.	Fruehauf AXA-0420-3 Euclid E-2099	

# Cam Shaft Repair Kits

## Meritor 1-5/8" Dia. Cam Shafts

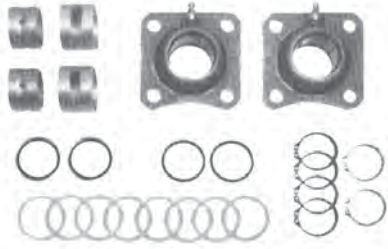

700-7-248

This kit can replace:  
Euclid E-3520A  
Sirco B8683



700-7-249

This kit can replace:  
Sirco B8645



700-7-9

This kit can replace:  
Sirco B8645A



## Meritor 1-1/2" Dia. Cam Shafts

700-7-7

This kit can replace:  
Euclid E-2088AHD

## Meritor Axles with Fabricated Spiders



RW-KIT8289

This kit can replace:  
Euclid E-6078



700-7-286

This kit can replace:  
Euclid E-9079HD

## Fruehauf Pro-Par



700-7-245

This kit can replace:  
Euclid E-2090  
Sirco B8649



700-7-169

This kit can replace:  
Sirco B8649A



700-7-8

Early Model

# Cam Shaft Repair Kits



**Eaton 501 Series  
Brakes**

700-7-303

This kit can replace:  
Euclid E-2696A

**Dana Spicer 1-1/2" Dia. Cam Shafts**



DA-M16KY202

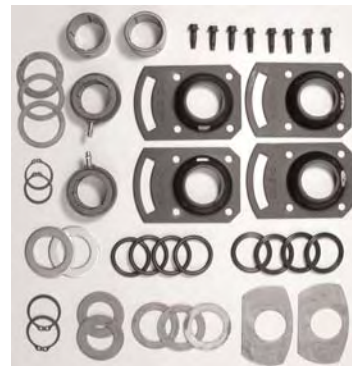

DA-M10KY106













**Dana Spicer  
1-5/8" Dia. Cam Shafts**

DA-M10KY105



# Cam Shaft Bushings & Brackets

Bushing	Part No.	O.D.	I.D.	Length	Note
	700-7-32	1-7/8"	1-1/2"	1-1/4"	Euclid E-536 Used in Kit 700-7-6
	700-7-33	1-7/8"	1-1/2"	1-1/2"	Euclid E-2291 Used in Kit 700-7-7
	700-7-34	1-7/8"	1-1/2"	1-1/4"	Euclid E-943
	700-7-35	2-3/4"	1-1/2"	2-1/2"	Euclid E-535
	700-7-37	2-1/8"	1-1/2"	1"	Euclid E-2361 Includes (2) E-1314 Used in Kits 700-7-9 & 700-7-249
	700-7-61	2"	1-5/8"	1-15/16"	Euclid E-2670 Used in Kits 700-7-9, 700-7-248, & 700-7-249
	700-7-62	1-7/8"	1-5/8"	7/8"	Euclid E-1567 Used in Kits 700-7-169 & 700-7-245
	700-7-64	2-7/8"	1-19/32"	2-1/2"	Euclid E-1571 Used in Kit 700-7-8 Includes Grease Zerk
	700-7-65	1-7/8"	1-1/2"	2"	Euclid E-661
	700-7-67	2-15/32"	1-1/2"	1-3/4"	Euclid E-2102
	700-7-68	2-1/2"	1-19/32"	1-1/2"	Euclid E-1577A Used in Kits 700-7-169 & 700-7-245
	700-7-205	2"	1-5/8"	1-3/16"	Euclid E-2690A Used in Kit 700-7-303

Bracket	Part No.	Application & Notes
	700-7-36	Euclid E-603 Early Model Meritor Axles Use with 700-7-35 Bushing
	700-7-219	Fruehauf ACD-2282 Use with 700-7-68 Bushing
	700-7-227	Euclid E-1318A Meritor A-3105-V-282 Used in Kits 700-7-7 & 700-7-248

# Cam Washers, Lock Rings & Seals

## WASHERS

Part No.	Replaces	O.D.	I.D.	Thickness	Note
700-7-40	Euclid E-581	2-1/4"	1-17/32"	0.032	Used on 1-1/2" Dia. Cam Shafts
700-7-41	Euclid E-580	2-1/4"	1-17/32"	0.06	Used on 1-1/2" Dia. Cam Shafts End Washer on Pro-Par Cam Shafts
700-7-94	Euclid E-564	2"	1-17/32"	0.05	Used with Meritor Cam Shaft Repair Kits
700-7-121	Euclid E-1565	2-3/8"	1-41/64"	0.059	Used with Pro-Par Cam Shaft Repair Kits
700-7-144	Euclid E-2411A	2-1/4"	1-5/8"	0.032	
700-7-174	Euclid E-3471	2-1/2"	1-5/16"	0.062	
700-7-96	Euclid E-656	3-7/8"	1-1/2"	1/16"	Used on 1-1/2" Dia. Cam Shafts



## LOCK RINGS

Part No.	Replaces		I.D.	Thickness	Note
700-7-38	Euclid E-526		1-31/64"	1/16"	Used on 1-1/2" Dia. Cam Shafts
700-7-72	Euclid E-1569		1-1/2"	1/16"	Used on 1-5/8" Dia. Cam Shafts



## SEALS

Part No.	Replaces	O.D.	I.D.	Thickness	Note
700-7-39	Euclid E-1416A	1-7/8"	1-1/2"	1/4"	Used on 1-1/2" Dia. Cam Shafts
700-7-73	Euclid E-654	2-1/16"	1-1/2"	1/4"	
700-7-178	Euclid E-2405	2"	1-5/8"	1/4"	Used in 700-7-61 Bushing



# Manual Slack Adjusters



**17-A23-100**  
10-Spline; 1-1/2"  
5", 6", & 7" Drilling



**17-A23-101**  
28-Spline; 1-1/2"  
5" & 6" Drilling



**17-A23-112**  
28-Spline; 1-1/2"  
5-1/2" Drilling



**17-A23-66B**  
37-Spline; 1-5/8"  
6" Drilling



**Rubber Boot**  
RW-2260S1111



**Guide Pawl**  
RW-R801700



**Clevis Pin**  
RW-19X1084



**1/4" Pin**  
RW-19X127

## Automatic Slack Adjusters

**RW-R801041**  
10-Spline; 1-1/2"  
5-1/2" Drilling

**RW-R801042**  
10-Spline; 1-1/2"  
6" Drilling

**RW-R801003**  
24-Spline; 1-1/4"  
5-1/2" Drilling

**RW-R801072**  
28-Spline; 1-1/2"  
5-1/2" Drilling

**RW-R801073**  
28-Spline; 1-1/2"  
5-1/2" Drilling

**RW-R801074**  
28-Spline; 1-1/2"  
6" Drilling



## MERITOR

**RW-R801102**  
37-Spline; 1-5/8"  
6" Drilling



**Clevis Kit**  
RW-R810019  
Kit Includes:  
RW-19X1084 Clevis Pin  
RW-19X127 1/4" Pin



**Slack Adjuster Kit  
(Minor)**  
RW-KIT963

# Automatic Slack Adjusters

## GUNITE



**Clevis Kit**  
GU-AS3000

### GU-AS1032

10-Spline; 1-1/2"  
5-1/2" Drilling

### GU-AS1041

28-Spline; 1-1/2"  
6" Drilling

### GU-AS1043

37-Spline; 1-5/8"  
5-1/2" Drilling

### GU-AS1033

10-Spline; 1-1/2"  
6" Drilling

### GU-AS1040

28-Spline; 1-1/2"  
5-1/2" & 6-1/2" Drilling

### GU-AS1044

37-Spline; 1-5/8"  
6" Drilling

## CREWSON BRUNNER

with Autocheck



### CB-41100

10-Spline; 1-1/2"  
5-1/2" Drilling

### CB-42100

28-Spline; 1-1/2"  
5-1/2" Drilling

### CB-42106

28-Spline; 1-1/2"  
6" Drilling

### CB-41106

10-Spline; 1-1/2"  
6" Drilling

### CB-22153

28-Spline; 1-1/2"  
5" & 6" Drilling  
Curved Arm; 12-1/4" Brakes

### CB-43106

37-Spline; 1-5/8"  
6" Drilling

## BENDIX



### BX-065174

28-Spline; 1-1/2"  
5-1/2" Drilling

### BX-065176

28-Spline; 1-1/2"  
6" Drilling

# Automatic Slack Adjusters

## HALDEX



### TRAILER

#### HA-400-10216

10-Spline; 1-1/2"  
6" Drilling

#### HA-400-10211

28-Spline; 1-1/2"  
5-1/2" Drilling

#### HA-400-10212

28-Spline; 1-1/2"  
6" Drilling

#### HA-400-10305

28-Spline; 1-1/2"  
6" Drilling  
12-1/4" Brakes

#### HA-400-10213

37-Spline; 1-5/8"  
5-1/2" Drilling

#### HA-400-10214

37-Spline; 1-5/8"  
6" Drilling

### TRAILER SELF-SET

#### HA-400-20215

10-Spline; 1-1/2"  
5-1/2" Drilling

#### HA-400-20211

28-Spline; 1-1/2"  
5-1/2" Drilling

#### HA-400-20213

37-Spline; 1-5/8"  
5-1/2" Drilling

### STEER AXLE

#### HA-400-10001

10-Spline; 1-1/4"  
5-1/2" Drilling

#### HA-400-10004

24-Spline; 1-1/4"  
5-1/2" Drilling

#### HA-400-10008

28-Spline; 1-1/2"  
5-1/2" Drilling

### DRIVE AXLE

#### HA-400-10142

10-Spline; 1-1/2"  
5 & 6" Drilling

#### HA-400-10143

10-Spline; 1-1/2"  
5-1/2" & 6-1/2" Drilling

#### HA-400-10155

10-Spline; 1-1/2"  
5-1/2" Drilling  
KW-8 Bag Air Ride

#### HA-400-10140

28-Spline; 1-1/2"  
5" & 6" Drilling

#### HA-400-10141

28-Spline; 1-1/2"  
5-1/2" & 6-1/2" Drilling

#### HA-400-10146

28-Spline; 1-1/2"  
5-1/2" & 6-1/2" Drilling

#### HA-400-10144

28-Spline; 1-1/2"  
6" Drilling  
Mack Truck



### Bracket Assembly

HA-427-10431



### Stud/Nut/Bushing

HA-427-10558



### Anchor Bracket

HA-427-10563

### Metal Dust Shields

For 16-1/2" X 7" Brakes  
(one wheel application)



7-A2-51

Used on cast spiders  
Replaces Euclid E-886

RW-R009095

Used on cast spiders

### Plastic Dust Shields

(one wheel application)

700-7-228

5" Round Axle



700-7-229L

700-7-229R

5" Square Axle



# Axle Nuts & Washers



## Outer Axle Nut

700-7-13

Thread 2-5/8"-16

Replaces:  
Meritor 1227-B-7596  
Euclid E-572



## Inner Axle Nut

700-7-11

Thread 2-5/8"-16

Replaces:  
Meritor 1227-C-549  
Euclid E-540



## Lockwasher

700-7-12

2-41/64" I.D.

3-7/8" O.D.

Replaces:  
Meritor 1229-V-1660  
Euclid E-573



## Lockwasher

RW-R000573

2-41/64" I.D.

3-7/8" O.D.

Replaces:  
Euclid E-3008  
Replacement Set Screw:  
RW-1199K3859

## REPLACEMENT SPINDLE NUT & WASHER FOR FRUEHAUF PRO-PAR AXLES



## Spindle Washer

700-7-15

3-1/2" I.D.

5-1/16" O.D.

x .255 Thick

Replaces:  
Fruehauf AXA-0408-1  
Euclid E-1561



## Spindle Nut

700-7-14

3.480-12 THD

x 4-3/4" AF

Replaces:  
Fruehauf ACE-8510-1  
Euclid E-2550



## Axle Nut Kit for TP Series Axles

RW-KITSTPN

3-1/2" Spindle



STEMCO™  
PRO-TORQ®  
ADVANCED AXLE SPINDLE NUTS

SM-447-4743

Standard HM Trailer

SM-447-4723

Pro-Par Trailer



## Spindle Nut Wrench

50-24J-3

8-Point

3-3/8" & 3-7/8" Openings

Replaces:  
Meritor 32560000  
Euclid E-844



## BEARINGS

Industry Number	Timken	Hyatt
567	TK-567	
580	TK-580	BG-580
582	TK-582	
593	TK-593	
594A	TK-594A	BG-594A
598A	TK-598A	BG-598A
663	TK-663	BG-663
665A	TK-665A	
3782	TK-3782	
212047	TK-HM212047	BG-HM212047
212049	TK-HM212049	BG-HM212049
218248	TK-HM218248	BG-HM218248
506310	TK-HH506310	
506348	TK-HH506348	
518445	TK-HM518445	BG-HM518445



## RACES

Industry Number	Timken	Hyatt
563	TK-563	
572	TK-572	BG-572
592A	TK-592A	BG-592A
653	TK-653	BG-653
3720	TK-3720	
212011	TK-HM212011	BG-HM212011
218210	TK-HM218210	BG-HM218210
518410	TK-HM518410	BG-HM518410

## BEARING / RACE SETS



Part No.	Set Consists of (1) Each:
TK-401	Timken 580 / 572
TK-403	Timken 594A / 592A
TK-405	Timken 663 / 653
TK-406	Timken 3782 / 3720
TK-413	Timken HM212049 / HM212011
TK-414	Timken HM218248 / HM218210
TK-415	Timken HM518445 / HM518410

# Oil Seal Interchange

STEMCO	NATIONAL		CR		TRISEAL MVP	DANA	
VOYAGER/GUARDIAN	STANDARD	FIVE STAR	SCOTSEAL	SCOTSEAL PLUS	UNITIZED	OUTRUNNER	DANA
<b>Trailer Axle Oil Seals</b>							
307-0744	370037A		43752	43753	65298U		853
373-0113	370036A	380036A	40136	40133	65261U	301	850
373-0123	370065A	380065A	42623	42622	65262U	302	851
373-0143	370025A	380025A	46305	46304	65060U	303	859
<b>Front Axle Oil Seals</b>							
382-8034	370012A		36285		65291U		
383-0136	370001A	380001A	35066	35059	65263U	305	847
383-0139	370033A*		39988*	39977*	65294U*		
383-0153	370124A		44922	44919	65000U		855
383-0156	370131A	380131A	45103	45102	65078U		857
383-0164	370048A	380048A	43764	43763	65092U		863
	370018A	380018A	32470		65116U		
	*Use with adapter AR12		*Use with adapter 455031	*Use with adapter 455031	*Use with adapter 67038		
<b>Drive Axle Oil Seals</b>							
309-0903	370022A		45099	45097	65270U		856
309-0915	370024A		38750		65024U		
309-0935	370047A	380047A	34387	34386	65111U		
309-0960	370005A		48000	48001	65165U	308	860
309-0964	370021A		45160	45158	65172U	307	858
309-0970	370006A		47699		65283U		
392-0148	370069A		52658		65030U		
393-0104	370031A	380031A	42672	42671	65071U		852
393-0112	370023A	380023A	38780	38799	65024U	306	849
393-0112	370023A	380023A	38780	38779	65152U	306	849
393-0173	370003A		47697	47695	65156U	304	861
	370106A		42550		65027U		
	370019A		43861	43860	65184U		854
	370033A		38709		65275U		



<b>STEMCO</b>	<b>NATIONAL</b>	<b>CR</b>	<b>TRISEAL MVP</b>	<b>DANA OUTRUNNER</b>
<b>TRAILER</b>	<b>TRAILER</b>	<b>TRAILER</b>	<b>TRAILER</b>	<b>TRAILER</b>
SM-307-0713	NA-370025A	CR-40136	TS-65060U	DA-850
SM-307-0723	NA-370036A	CR-42623	TS-65262U	DA-851
SM-307-0743	NA-370065A	CR-42627	TS-70561	DA-859
SM-307-0744	NA-376590A	CR-46300	TS-70596	
SM-372-7015	NA-380025A	CR-46305	TS-70598	<b>DRIVE AXLE</b>
SM-372-7062	NA-380036A			DA-849
SM-372-7097	NA-380065A	<b>DRIVE AXLE</b>	<b>DRIVE AXLE</b>	DA-861
SM-372-7098		CR-47692	TS-65156U	
SM-372-7099	<b>DRIVE AXLE</b>	CR-47697	TS-70799	<b>FRONT AXLE</b>
SM-373-0144	NA-370003A			DA-847
	NA-370022A	<b>FRONT AXLE</b>	<b>FRONT AXLE</b>	DA-863
<b>DRIVE AXLE</b>	NA-370031A	CR-35066	TS-69697	
SM-309-0973	NA-380003A	CR-43764	TS-69699	
SM-392-9094	NA-380023A			
SM-392-9099				
SM-392-9112	<b>FRONT AXLE</b>			
SM-392-9131	NA-370001A			
	NA-370131A			
<b>FRONT AXLE</b>	NA-380001A			
SM-308-0836				
SM-382-8036				

## Stemco Hub Caps, Gaskets, Window Kits, & Vent Plugs

<b>Hub Caps</b>				<b>Gaskets</b>	<b>Window Kits</b>	<b>Vent Plugs</b>
SM-300-4009 (Bulk Pack)	SM-340-4075	SM-342-4339	SM-343-4350	SM-330-3009	SM-359-5912	SM-359-5915
	SM-340-4095	SM-343-4009	SM-347-4009	SM-330-3024	SM-359-5992	SM-359-5990
SM-340-4009	SM-340-4195	SM-343-4013	SM-347-4013	SM-330-3067	SM-359-5995	SM-359-6124
SM-340-4013	SM-340-4249	SM-343-4024	SM-347-4075	SM-330-3107	SM-359-5999	
SM-340-4019	SM-340-5096	SM-343-4075	SM-347-4195	SM-330-3118	SM-359-6095	
SM-340-4024	SM-340-5097	SM-343-4095	SM-348-4009	SM-330-3122	SM-359-6117	
SM-340-4046	SM-342-4009	SM-343-4195	SM-640-0001			
SM-340-4059	SM-342-4075	SM-343-4249	SM-640-0003			

# Misc. Hub Caps, Gaskets & Plugs

Part No.	Description		
CR-1343	6-Hole	5-1/2" Bolt Circle	Type TP1
CR-1643	6-Hole	5-1/2" Bolt Circle	Type TF8
CR-1644	6-Hole	5-1/2" Bolt Circle	Type TF8
CR-1743	6-Hole	5-1/2" Bolt Circle	Type H3

## Chicago Rawhide Hub Caps



## Side Hole Plug 8-6-85

Part No.	Description		
700-101-89	5-Hole	5-1/2" Bolt Circle	Lexan Hubo Mount
700-101-88	6-Hole	5-1/2" Bolt Circle	Lexan Hubo Mount
TS-64009S	6-Hole	5-1/2" Bolt Circle	
700-8-35	Universal Hub Cap Gasket (Replacement for Stemco 330-3067)		

## Misc. Hub Caps & Gasket



## Hubcap Mounting Bolt with Washer

700-50-18  
5/16"-18 x 7/8" Long



Part No.	Description	Replaces Fruehauf:
700-8-5	Lexan Hub Cap	ACC 07538900
700-8-6	O-Ring	AXA 00484001
700-8-7	Top Oil Plug	
700-101-90	Lexan Hub Cap, Hubodometer Mounting	

## Pro-Par Replacements

# Hubodometer Mounting Brackets

## Veeder-Root Mounting Brackets

**VR-325614-101**

For drive-axle applications

**VR-325614-012**

For over-hub-cap applications

## Stemco Mounting Brackets

Part No.	Bolt Circle Diameter	Stud Size	Height	Style
SM-610-0006	7"	5/8"	1-11/16"	A
SM-610-0007	7"	3/4"	1-11/16"	A
SM-610-0011	5-1/4" - 7-3/4"	1/2"	1-3/4"	Universal Mount
SM-610-0024	5-1/2"	5/16"-18 Thread	4-1/2"	Over Hub Cap
SM-610-0065	5-1/2"	5/16"	3-1/2"	A -- Fits over 4009 Hub Cap
SM-610-0085	5-1/2"	5/16"	4"	

To measure bolt circle diameter:  
(on axles with an even number of studs)

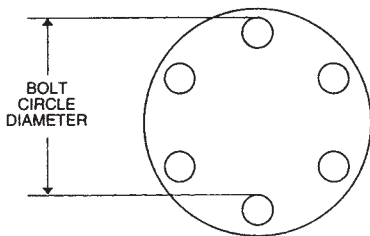

Style A

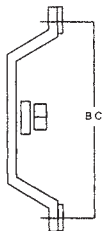

### Universal Mount

Can be assembled in minutes to fit most drive axles. The Standard Kit fits 5 1/2" to 7 3/4" bolt circles and 1/2" stud size.

### Part No. 610-0011

- 1 - Angles
- 2 - Strap
- 3 - Washer
- 4 - Nut
- 5 - Rivets

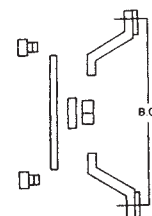

# Hubodometers



**Veeder-Root**

Part No.	Description
VR-777717-475	475 Tire Revolutions equal 1-Mile
VR-777717-490	490 Tire Revolutions equal 1-Mile
VR-777717-494	494 Tire Revolutions equal 1-Mile
VR-777717-500	500 Tire Revolutions equal 1-Mile
VR-777717-510	510 Tire Revolutions equal 1-Mile
VR-777717-514	514 Tire Revolutions equal 1-Mile
VR-777717-520	520 Tire Revolutions equal 1-Mile
VR-777717-525	525 Tire Revolutions equal 1-Mile
VR-777717-572	572 Tire Revolutions equal 1-Mile
VR-777717-676	676 Tire Revolutions equal 1-Mile



**Stemco**

Part No.	Tire Size			
	SM-650-0587	10.00 - 22	11 - 24.5	
SM-650-0593	11.5 - 20	11.00 - 20	11.00R20	12 - 22.5
	12.5 - 22.5	12.5R22.5	12.75R22.5	12R22.5
	14180R20	365/70R22.5	365/80R20	
SM-650-0598	10.00 - 20	11 - 22.5	15 - 22.5	15R22.5
SM-650-0601	10.00R20	315/75R22.5	9.00 - 20	10 - 22.5
	11R22.5	13/80R20	275/80R24.5	285/75R24.5
	295/80R22.5	295/85R22.5		
SM-650-0605	12.5R20			
SM-650-0608	9.00 - 20	10 - 22.5	10R22.5	275/80R22.5
SM-650-0610	10.00/90R20	275/80R22.5	295/75R22.5	315/70R22.5
	9.00R20			
SM-650-0619	11/70R22.5			
SM-650-0626	10.00 - 15	255/70R22.5	37X12.50R16.5	

# Wheels and Drums

---

<b>SPOKE WHEELS .....</b>	<b>2-1</b>
<b>HUB AND DRUM ASSEMBLIES .....</b>	<b>2-2</b>
<b>5-SPOKE WHEEL AND DRUM ASSEMBLY .....</b>	<b>2-2</b>
<b>OUTBOARD HUBS .....</b>	<b>2-3</b>
<b>INBOARD HUBS .....</b>	<b>2-4</b>
<b>BRAKE DRUMS – DISC WHEEL APPLICATIONS .....</b>	<b>2-5</b>
<b>BRAKE DRUMS – TRACTOR APPLICATIONS .....</b>	<b>2-6</b>
<b>BRAKE DRUMS – SPOKE WHEEL APPLICATIONS .....</b>	<b>2-7</b>
<b>SPACER BANDS .....</b>	<b>2-7</b>
<b>WHEEL STUDS AND NUTS .....</b>	<b>2-8 TO 2-10</b>
<b>SPOKE-WHEEL RIM NUTS AND CLAMPS .....</b>	<b>2-10</b>
<b>DISC WHEELS – STEEL AND ALUMINUM .....</b>	<b>2-11</b>
<b>TUBELESS SERVICE RIMS .....</b>	<b>2-12</b>
<b>TUBE-TYPE RIM ASSEMBLIES .....</b>	<b>2-12</b>
<b>VALVE STEMS &amp; ACCESSORIES .....</b>	<b>2-13</b>
<b>WHEEL-GUARD, HUG-A-LUG NUT COVERS, AND BOLT KIT .....</b>	<b>2-14</b>

## 3-Spoke Wheels

Part No.	Size	Races		Note	Brake Drum Application
		Inner	Outer		
WB-70159--A	15"	HM218210	HM212011	Includes 4" Spacer Band WB-3314 Rim Clamps 8-15-4 Nuts	12-1/4" x 7" Use Webb 63637
WB-83153--A	15"	653	HM212011	Includes 4" Spacer Band WB-3314 Rim Clamps 8-15-4 Nuts	12-1/4" x 7" Use Webb 63647

## 5-Spoke Wheels

Part No.	Size	Races		Note	Brake Drum Application
		Inner	Outer		
WB-75209--A	20"	HM218210	HM212011	Includes 4" Spacer Band 8-8-6 Rim Clamps 8-15-4 Nuts	16-1/2" x 7" Use Webb 67518
DW-47-14018-007	20"	HM218210	HM212011	Less Spacer Band Less Rim Clamps Includes 8-15-4 Nuts	16-1/2" x 7" Use DW-03-122222
WB-5580Z--A	20"	HM518410	HM518410	Includes 4" Spacer Band 8-8-6 Rim Clamps 8-15-4 Nuts	16-1/2" x 7" Use Webb 68730
WB-85203--A	20"	653	HM212011	Includes 4" Spacer Band 8-8-6 Rim Clamps 8-15-4 Nuts	16-1/2" x 7" Use Webb 67518
DW-47-07791-013	20"	653	HM212011	Less Spacer Band Less Rim Clamps Includes 8-15-4 Nuts	16-1/2" x 7" Use DW-03-122222
WB-85223--A	22"	653	HM212011	Includes 4" Spacer Band 8-8-6 Rim Clamps 8-15-4 Nuts	16-1/2" x 7" Use Webb 67518

## 6-Spoke Wheels

Part No.	Size	Races		Note	Brake Drum Application
		Inner	Outer		
WB-76229--M	22"	HM218210	HM212011	Less Spacer Band Less Rim Clamps Includes 8-15-4 Nuts	16-1/2" x 7" Use Webb 67518
WB-5682Z--A	22"	HM518410	HM518410	Includes 4" Spacer Band 8-8-6 Rim Clamps 8-15-4 Nuts	16-1/2" x 7" Use Webb 68765

## Hub & Drum Assemblies

Part No.	Side	Races		Hub	Drum	Stud	Note
		Inner	Outer				
WB-20231UQMR	R.H.	HM218210	HM212011	Webb-2023	WB-66864	Webb 101172 Euclid E-9010R	Outboard Stud Pilot
WB-20231UQML	L.H.	HM218210	HM212011	Webb-2023	WB-66864	Webb 101173 Euclid E-9010L	Outboard Stud Pilot
WB-20231UH5	---	HM218210	HM212011	WB-20231--5	WB-66884	700-7-288	Outboard Hub Pilot
BU-2809001	---	HM218210	HM212011	BU-2819001	BU-2308712	700-7-232	Outboard Hub Pilot
MW-89404B	---	HM518410	HM518410	89403	MW-88797B	700-7-267	Outboard 8-Hole
BU-4809003	R.H.	HM218210	HM212011	4819003	BU-2308712	Euclid E-8949R	Outboard Stud Pilot ABS Ready
BU-4809004	L.H.	HM218210	HM212011	4819004	BU-2308712	Euclid E-8949L	Outboard Stud Pilot ABS Ready
BU-4809002	---	HM218210	HM212011	4819002	BU-2308712	700-7-269	Outboard Hub Pilot ABS Ready

## 5-Spoke Wheel & Drum Assembly

Part No.	Size	Races		Note	Wheel
		Inner	Outer		Drum
WB-75209GCA	20"	HM218210	HM212011	Includes 4" Spacer Band 8-8-6 Rim Clamps 8-15-4 Nuts	WB-75209--A WB-67518

Part No.	Races		Stud	Brake Drum Application	Note
	Inner	Outer			
WB-20231--5	HM218210	HM212011	Includes 700-7-288	16-1/2" x 7" Use WB-66884	This hub can be set up for stud pilot mounting by changing studs to Euclid E-9010R&L
WB-20231--5T	HM218210	HM212011	Includes 700-7-288	16-1/2" x 7" Use WB-66884	Includes ABS tone ring. This hub can be set up for stud pilot mounting by changing studs to Euclid E-9010R&L
BU-2819001	HM218210	HM212011	Includes 700-7-232	16-1/2" x 7" Use BU-2308712	Can replace: WB-20231--5 DW-04-15501-001
DW-04-15501-001	HM218210	HM212011	Less Studs	16-1/2" x 7" Use DW-03-123207	For hub pilot mounting with dual steel wheels, use stud no. 700-7-271. For stud pilot mounting, use stud nos. 700-7-278 and 700-7-279
DW-04-15571-001	HM218210	HM212011	Includes 700-7-271	16-1/2" x 7" Use DW-03-123207	Includes ABS tone ring. For dual aluminum wheels, use stud no. 700-7-280
WB-10209--N	HM218210	HM212011	Less Studs	16-1/2" x 7" Use WB-66893	Use stud nos. Webb 159183 and 159184
DW-04-14344-004	HM218210	HM212011	Less Studs	16-1/2" x 7" Use DW-03-120877	Use stud nos. 50-33A-25 and 50-33A-26
MW-89425	HM218210	HM212011	Includes 700-7-267	16-1/2" x 7" Use MW-88797B	8-hole mounting
MW-89403	HM518410	HM518410	Includes 700-7-267	16-1/2" x 7" Use MW-88797B	8-hole mounting
WB-23231--3	HM518410	HM518410	Includes 700-7-281	16-1/2" x 7" Use WB-66884	This hub can be set up for stud pilot mounting by changing studs to Euclid E-9010R&L
WB-23231--5T	HM518410	HM518410	Includes 700-7-288	16-1/2" x 7" Use WB-66884	Includes ABS tone ring. This hub can be set up for stud pilot mounting by changing studs to Euclid E-9010R&L
WB-1320Z--N	HM518410	HM518410	Less Studs	16-1/2" x 7" Use WB-66893	Use stud nos. Webb 159183 and 159184
WE-10-00011-001	HM218210	HM212011	Includes 02-00014	16-1/2" x 7" Use DW-03-123207	Hub pilot Dura-Light hub For dual aluminum wheels
WE-10-00011-101	HM218210	HM212011	Includes 02-00014	16-1/2" x 7" Use DW-03-123207	Hub pilot Dura-Light hub For dual aluminum wheels ABS ready
WE-10-00011-103	HM218210	HM212011	Includes 02-00027	16-1/2" x 7" Use DW-03-123207	R.H. stud pilot Dura-Light hub For cast brake drum ABS ready
WE-10-00011-104	HM218210	HM212011	Includes 02-00028	16-1/2" x 7" Use DW-03-123207	L.H. stud pilot Dura-Light hub For cast brake drum ABS ready
WE-10-00011-105	HM218210	HM212011	Includes 02-00031	16-1/2" x 7" Use DW-53-123537	R.H. stud pilot Dura-Light hub For centrifuse brake drum ABS ready
WE-10-00011-106	HM218210	HM212011	Includes 02-00032	16-1/2" x 7" Use DW-53-123537	L.H. stud pilot Dura-Light hub For centrifuse brake drum ABS ready
CO-105776	HM218210	HM212011	Includes 102190	16-1/2" x 7" Use WB-66864	Hub pilot aluminum hub For dual aluminum wheels



# Inboard Hubs

---

Part No.	Races		Stud	Brake Drum Application	Note
	Inner	Outer			
DW-04-14059-001	HM218210	HM212011	Less Studs	16-1/2" x 7" Use DW-03-012582	For dual steel wheels Use stud nos. Euclid E-8958R&L
WB-10019--N	HM218210	HM212011	Less Studs	16-1/2" x 7" WB-62200	For dual steel wheels Use stud nos. Euclid E-5561R&L
DW-04-14935-001	HM518410	HM518410	Less Studs	16-1/2" x 7" Use DW-03-122126	For dual steel wheels Use stud nos. Euclid E-8954R&L
WB-1331Z--N	HM518410	HM518410	Less Studs	16-1/2" x 7" WB-68730	For dual steel wheels Use stud nos. Webb 183101 and 183102

## Disc Wheel Trailer Applications

Part No.	Brake Size	Replaces Hayes Lemmerz	Replaces Dayton	Replaces Webb	Replaces Gunite
DW-03-012582	16-1/2" x 7"	87407	---	62200	2705
DW-03-120877	16-1/2" x 7"	---	---	60876	3120
DW-03-122607	16-1/2" x 7"	87101	---	66893	3166
DW-03-123207	16-1/2" x 7"	89996	---	66864	3600A
DW-03-123365	16-1/2" x 7"	89996	---	66864	3600A
DW-53-123537	16-1/2" x 7"	89996	03-123207	66864	3600A
DW-53-123564	16-1/2" x 7"	87101	03-122607	66893	3166
DW-53-123566	16-1/2" x 7"	88797	---	66875	3141B
DW-85-123207	16-1/2" x 7"	89996B	---	66884B	3600A
MW-87101B	16-1/2" x 7"	---	53-123564	67101	3166
MW-87128B	15" x 7"	---	03-123315	61571	3219
MW-87156B	16-1/2" x 7"	---	03-122550	67156	3141
MW-87407B	16-1/2" x 7"	---	03-012582	67407	2705
MW-87415B	16-1/2" x 7"	---	03-122126	67415	3018A
MW-87417B	16-1/2" x 7"	---	03-012734	68921	2546
MW-87615B	16-1/2" x 8-5/8"	---	03-122460	66815	---
MW-88797B	16-1/2" x 7"	---	53-123566	66875	3141B
MW-89651B	16-1/2" x 7"	---	---	66878	---
MW-89996B	16-1/2" x 7"	---	53-123537	66884	3600A
WB-60876	16-1/2" x 7"	---	03-120877	---	3120
WB-62200	16-1/2" x 7"	87407	03-012582	---	2705
WB-63631	12-1/4" x 7-1/2"	---	---	---	3557
WB-66353	16-1/2" x 7"	---	---	---	3757
WB-66812	16-1/2" x 10"	---	---	---	3475
WB-66864	16-1/2" x 7"	89996	03-123207	---	3600A
WB-66864B	16-1/2" x 7"	89996B	85-123207	---	3600A
WB-66873	16-1/2" x 7"	89877	---	---	3402
WB-66875	16-1/2" x 7"	88797	53-123566	---	3141B
WB-66884	16-1/2" x 7"	89996	03-123365	---	3600A
WB-66884B	16-1/2" x 7"	89996B	85-123207	---	3600AX
WB-66893	16-1/2" x 7"	87101	03-122607	---	3166
WB-66815	16-1/2" x 7"	87615B	03-122460	---	---
WB-68891	16-1/2" x 8-5/8"	---	---	---	3383

# Brake Drums

## Tractor Applications

Part No.	Brake Size	Replaces Hayes Lemmerz	Replaces Dayton	Replaces Webb	Replaces Gunite
	Application				
DW-03-120754	16-1/2" x 7" Mack	87435	---	61780	2577A
DW-03-122550	16-1/2" x 7" Kenworth	87156	---	66895	3141
DW-03-123396	15" x 4"	---	---	61527B	---
DW-03-123397	16-1/2" x 7"	---	---	66874B	3600AX
MW-87295B	16-1/2" x 7" Mack	---	13-122453	66892	3543
MW-87945BK	15" x 5-1/2"	---	---	65550B	3608X
MW-88870BK	15" x 4"	---	---	65543	---
MW-89870BK	15" x 4"	---	03-123423	65545	3721A
MW-89877BK	16-1/2" x 7"	---	---	66873	3402X
MW-90089BK	15" x 4-1/2"	---	---	65547B	3721AX
WB-61527B	15" x 4-3/4"	---	---	---	3721X
WB-61528B	15" x 4-3/4"	---	13-123254	---	3721AX
WB-62997	16-1/2" x 7" Mack	---	03-122009	---	2997
WB-65167B	16-1/2" x 6"	---	---	---	3437X
WB-65541B	15" x 4"	---	---	---	3158X
WB-66892	16-1/2" x 7" Navistar	87295	03-122453	---	3543
WB-66895B	16-1/2" x 7" Kenworth	87156	13-122550	---	3141
WB-68981B	16-1/2" x 7"	---	03-122683	---	3295A

## Spoke Wheel Applications

Part No.	Brake Size	Replaces Hayes Lemmerz	Replaces Dayton	Replaces Webb	Replaces Gunite
DW-03-012480	16-1/2" x 7"	86036	---	68903	1930
DW-03-120574	16-1/2" x 7"	---	---	62240	2974
DW-03-122126	16-1/2" x 7"	85130	---	68730	3018A
DW-03-122222	16-1/2" x 7"	86141	---	67518	2983C
WB-62240	16-1/2" x 7"	---	03-120574	---	2974
WB-63637	12-1/4" x 7-1/2"	---	---	---	3467
WB-63647	12-1/4" x 7-1/2"	---	03-120822	---	3175
WB-63680	12-1/4" x 8"	---	---	---	---
WB-67518	16-1/2" x 7"	86141	03-122222	---	2983C
WB-68730	16-1/2" x 7"	85130	02-122126	---	3018A
WB-68765	16-1/2" x 7"	86356	03-120586	---	2546C
WB-68897	16-1/2" x 7"	---	13-122600	---	8656
WB-68981B	16-1/2" x 7"	85704	---	---	3295AX

## Spacer Bands

Part No.	Size	Replaces Firestone	Replaces Goodyear
8-5-41	15 x 4	SB78F134	SB4015K
8-5-48	20 x 3-3/8	SB14F102	SB3320K
8-5-30	20 x 3-5/8	SB14F125	SB3520K
8-5-42	20 x 4	SB14F97	SB4020K
8-5-59	20 x 4-1/4	SB14F95	SB4220K
8-5-53	20 x 4-1/2	SB14F126	SB4420K
8-5-33	22 x 3-3/8	SB50F102	SB3322K
8-5-34	22 x 3-5/8	SB50F125	SB3522K
8-5-49	22 x 4	SB50F97	SB4022K
8-5-38	22 x 4-1/4	SB50F95	SB4222K
8-5-38HD	22 x 4-1/4	---	SB4222R
8-5-54	22 x 4-1/2	---	SB4422K
8-5-56	24 x 4	---	SB4024K
8-5-61	24 x 4-1/4	---	SB4224K
8-5-58	24 x 4-1/2	---	SB4424K



**Smooth Channel**

# Wheel Studs & Nuts

## Serrated Wheel Studs – Stud Body Diameter .783/.786

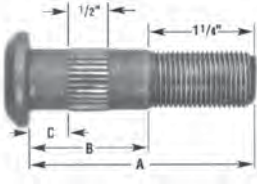
 <p>Grade 8 3/4" -16 Thd</p>	Part No. R.H.	Part No. L.H.	Replaces	A	B	C
	50-33A-29	50-33A-30	Hayes Lemmerz 59263 / 59264 Euclid E-4966R&L	2-5/8"	1-1/4"	5/16"
	50-33A-25	50-33A-26	Hayes Lemmerz 49851 / 49852 Euclid E-4968R&L	2-7/8"	1-1/2"	1/2"
	700-7-77	700-7-79	Hayes Lemmerz 59183 / 59184 Euclid E-4969R&L	3-1/8"	1-3/4"	9/16"

## Serrated Wheel Studs

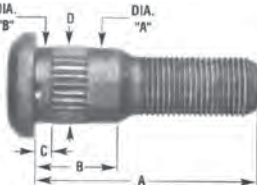
 <p>Grade 8 3/4" -16 Thd</p>	Part No. R.H.	Part No. L.H.	Replaces	Stud Body Dia		A	B	C	D
				A	B				
	700-7-278	700-7-279	Dayton 09-001910 & 1911	.890	.890	2-5/8"	31/32"	1/8"	3/8"

## Metric Studs – Stud Body Diameter .901

 <p>Grade 10.9 M22 x 1.5 Thd</p>	Part No.	Replaces	A	B	C	D	Note
	700-7-232	Hayes Lemmerz 106216 Euclid E-5997	3-21/32"	1-7/32"	2-7/64"	13/32"	
	700-7-269	Hayes Lemmerz 106216 Euclid E-5997	4-29/64"	1-7/32"	2-29/32"	13/32"	Dual aluminum wheels

## Metric Clipped Head Studs – Stud Body Diameter .981

 <p>Grade 10.9 M22 x 1.5</p>	Part No.	Replaces	A	B	C
	700-7-267	Hayes Lemmerz 88836 Euclid E-5992A	3-9/16"	23/32"	2-15/32"

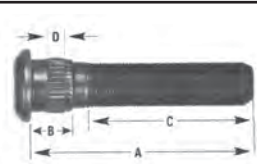

## Metric Serrated Studs

 <p>Grade 10.9 M22 x 1.5 Thd</p>	Part No.	Replaces	Stud Body	A	B	C	D
	700-7-271	Dayton 09-001989	.890	3-47/64"	7/8"	2-9/16"	1/8"
	700-7-280	Dayton 09-002003	.890	4-7/8"	7/8"	3-23/32"	1/8"
	700-7-281	Webb 101162 Euclid E-6035	.975	3-15/16"	23/32"	2-11/16"	3/8"

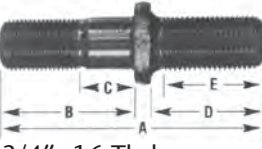

## Clipped Collar Shoulder Studs - Stud Body Diameter .784

 3/4" -16 Thd BOTH ENDS Grade 8	Part No. R.H.	Part No. L.H.	Replaces	A	B	C	D	E
	50-33A-9	50-33A-10	Hayes Lemmerz 13096 / 13097 Euclid E-5556R&L	3-19/32"	2-1/16"	7/8"	1-11/32"	1-5/32"



## Inner Nuts for Disc Wheels

 Grade 8 Equivalent	Part No. R.H.	Part No. L.H.	Replaces	Outer Thread Size	Inner Thread Size	Overall Length	Application
	50-34B-1	50-34B-2	Euclid E-7895R&L	1-1/8" -16	3/4" -16	2-7/32"	Dual Steel Wheels
	700-7-78	700-7-80	Euclid E-7897R&L	1-1/8" -16	3/4" -16	3-1/16"	Steel Inner Alum Outer Wheels
 Grade 8	50-34B-17	50-34B-18	Euclid E-5988R&L	1-1/8" -16	3/4" -16	3-1/16"	Dual Aluminum Wheels

## Outer Nuts for Disc Wheels

 Grade 5 Equivalent	Part No. R.H.	Part No. L.H.	Replaces	Thread Size	Hex Size	Height	Application
	50-34C-1	50-34C-2	Euclid E-5552R&L	1-1/8" -16	1-1/2"	7/8"	Outer Dual Large Stud Single Mounting
	50-34A-1	50-34A-2	Euclid E-5652R&L	3/4" -16	1-1/2"	7/8"	Single Mounting

## Flanged Cap Nuts for Disc Wheels

	Part No.	Replaces	Thread Size	Hex Size	Height	Application
	50-34C-19	Euclid E-5991 Hayes Lemmerz 88881	M22x1.5	1-1/2"	1-1/2"	Hub Pilot Wheels 8-Stud
	700-7-226	Euclid E-6000 Hayes Lemmerz 106333	M22x1.5	33mm	1-7/32"	Hub Pilot Wheels 10-Stud

# Wheel Studs & Nuts

## Cast Spoke Wheel Studs

 Grade 8	Part No.	Replaces	Thread	A	B	C
	8-9-7	Euclid E-4958	5/8" -11	2-3/4"	7/8"	1-11/16"
	8-9-8	Euclid E-4956A	3/4" -10	3"	1-1/16"	1-3/4"

## Spoke Wheel Rim Nuts & Clamps

### Rim Nuts for Spoke Wheels

 Grade 5	Part No.	Replaces	Thread	Hex
	8-16-3	Euclid E-4962 Dayton 08-005149	5/8" -11	1-1/16"
	8-15-4	Euclid E-4963 Dayton 08-005716	3/4" -10	1-1/4"

### Rim Clamps for Spoke Wheels

	Part No.	Replaces	A	B	C	D	Spacer Width
	8-8-3	Euclid E-5570 Dayton 09-541417	1"	2-7/8"	2-1/2"	5/8"	4"
	8-8-6	Euclid E-5571A Dayton 09-612317	1-1/8"	2-7/8"	2-1/2"	3/4"	4"
	8-8-17	Euclid E-5572A Dayton 09-623517	1-3/4"	2-7/8"	2-1/2"	3/4"	3-3/8"
	8-8-20	Euclid E-5040A Dayton 09-699317	1-1/2"	2-7/8"	2-1/2"	3/4"	3-5/8"

### Rim Clamps for 3-Spoke Wheels

	Part No.	Replaces	A	B	C	D	Wheel Size
	WB-3314	Euclid E-5953 Webb 3314	1-1/4"	7-3/4"	1-13/16"	3/4"	15"
	WB-3320	Euclid E-5824 Webb 3320	1-1/8"	10-5/8"	2-1/2"	3/4"	20"
WB-3322	Euclid E-5825 Webb 3322	1-1/16"	12-5/16"	2-5/16"	3/4"	22"	

## Steel Disc Wheels

Accuride Part No.	Hayes Lemmerz Part No.	Size	Mounting Type	Color	Number of Hand Holes	Number of Mounting Holes
AC-28112	---	17.5" x 6.75"	Stud Pilot	Gray	2	10
AC-28112-W	---			White	2	10
---	MW-10013-W		Hub Pilot	White	4	8
AC-27403	---	22.5" x 7.5"	Stud Pilot	Gray	2	10
AC-27404N	MW-87905	22.5" x 8.25"	Stud Pilot	Gray	2	10
AC-27404N-W	MW-87905-W			White	2	10
---	MW-90262		Hub Pilot	Gray	5	10
AC-28408-W	MW-90541-W			White	2	10
---	MW-90262-W			White	5	10
---	MW-90262-W			White	5	10
AC-27406-N	MW-87897	24.5" x 8.25"	Stud Pilot	Gray	2	10
AC-27406-N-W	MW-87897-W			White	2	10
AC-28409-W	MW-90542-W		Hub Pilot	White	2	10
---	MW-89922-W	24.5" x 8.25" Heavy Duty	Stud Pilot	White	2	10

## Alcoa Aluminum Disc Wheels

Part No.	Size	Mounting Type	Polished Location	Number of Mounting Holes	
AL-883110	22.5" x 8.25"	Stud Pilot	Unpolished	10	
AL-883111			Outside	10	
AL-883112			Inside	10	
AL-883420		Hub Pilot	Unpolished		8
AL-883640					10
AL-883641				Outside	10
AL-883642				Inside	10
AL-983120	24.5" x 8.25"	Stud Pilot	Unpolished	10	
AL-983121			Outside	10	
AL-983122			Inside	10	
AL-983640		Hub Pilot	Unpolished		10
AL-983641				Outside	10
AL-983642				Inside	10
AL-983642				Inside	10



# Demountable Rims

## Tubeless Service Rims

Accuride Part No.	Hayes Lemmerz Part No.	Size	Color	Rim Offset	Approximate Weight (lbs)	Maximum Load (lbs)
AC-31868-17.5	---	17.5" x 6.75"	Gray	3.90"	50	4805
AC-31814-17.5	---	17.5" x 8.25"	Gray	4.75"	55	6040
AC-30371-22.5	---	22.5" x 7.5"	Gray	4.26"	64	6610
AC-30391N-22.5	MW-825225DVL	22.5" x 8.25"	Gray	4.75"	68	7300
AC-30391N-22.5-W	MW-825225DVL-W		White	4.75"	68	7300
AC-32052-22.5	---	22.5" x 9"	Gray	5.00"	87	10,000
---	MW-825245DVL	24.5" x 8.25"	Gray	4.75"	75	7300
AC-30391N-24.5-W	MW-825245DVL-W		White	4.75"	75	7300



## 3-Piece 5° Heavy-Duty Tube-Type Rim Assemblies

Part No.	Size	Color	Side Ring Part No.	Lock Ring Part No.	Approximate Weight (lbs)	Maximum Load (lbs)
AC-275-5-1	20 x 8.0	Gray	AC-SR262-5	AC-LR240-5	80	7600
AC-277-5-1	24 x 8.0		AC-SR264-5	AC-LR242-5	98	
AC-313-5-1	24 x 8.5		---	---	118	8900







## Valve Stems for Steel Wheels

	Part No.	TR No.	Effective Length
	TV-501	501	1-1/2"
	TV-500	500	2"
	TV-571A	571A	3-3/8"
	50-58-6	572	3-3/4"
	50-58-5	573	4-3/8"

## Valve Stems for Aluminum Wheels

	Part No.	TR No.	Bend Angle	B Length
	TV-543D	543D	60-degree	1-3/8"
	TV-544D	544D		2"
	50-58-25	545D		2-5/8"
	Part No.	TR No.	Bend Angle	Effective Length
	TV-511	511	90-degree	4-1/4"
	50-58-15	509		4-3/4"
	TV-510	510		5-1/2"

## Accessories

	Part No.	Tire & Rim No.	Description
	TV-A-100-VC-1	C-1	Standard-Bore Valve Core
	TV-A-100-VC-3	VC-3	Metal Dome Valve Cap
	700-99-499		Double-Seal Metal Valve Cap
	TV-A-100-VC-8	VC-8	Plastic Dome Valve Cap
	TV-G-170	RG-15	Grommet for TV-500 Series, TV-570 Series
	TV-G-172	RG-46	Grommet for TV-509, 510, 511
	TV-HE-392		Valve Extension Long 1" Collar Effective Length 5-1/8"

# Miscellaneous



## Wheel-Guard

	Part No.	Note
	AC-5901	10-hole, 11-1/4" bolt circle, stud pilot; 7/8" and 1-1/8" diameter studs
	AC-5902	10-hole, 11-1/4" bolt circle, stud pilot; 3/4" diameter studs
	AC-5903	10-hole, 285.75mm bolt circle, hub pilot; 22mm diameter studs

## Bolt Kit for Spoke Wheel & Drum

	Part No.	Note
	700-50-34	5 each 2-1/2" -16 Grade 8 bolts; lock nuts; lock washers

## Hug-A-Lug Nut Covers

	Part No.	Note	Fits Nut Part Nos.
	AL-000150	1-1/2" hex for stud pilot wheels	50-34C-1 50-34C-2
	AL-000181	33mm hex for hub pilot wheels	700-7-226
	AL-000182	1-1/2" hex for hub pilot wheels	50-34C-19

<b>GLAD HANDS</b> .....	<b>3-1 TO 3-2</b>
<b>GLAD HAND COMPONENTS</b> .....	<b>3-2 TO 3-4</b>
<b>AIR HOSE</b> .....	<b>3-5 TO 3-6</b>
<b>AIR CHAMBERS</b> .....	<b>3-7 TO 3-8</b>
<b>AIR TANKS</b> .....	<b>3-9</b>
<b>HOSE SEPARATORS AND SPRINGS</b> .....	<b>3-10</b>
<b>NOSE BOXES</b> .....	<b>3-10</b>
<b>DRAIN COCKS AND VALVES</b> .....	<b>3-11</b>
<b>POGO STICKS</b> .....	<b>3-11</b>
<b>BRASS FITTINGS</b> .....	<b>3-12 TO 3-17</b>
<b>SEALCO AIR VALVES</b> .....	<b>3-18 TO 3-22</b>
<b>BENDIX AIR VALVES</b> .....	<b>3-22 TO 3-23</b>
<b>HALDEX AIR VALVES</b> .....	<b>3-24</b>
<b>MERITOR WABCO AIR VALVES</b> .....	<b>3-25</b>
<b>RIDEWELL AIR VALVES</b> .....	<b>3-26</b>
<b>HADLEY AIR VALVES</b> .....	<b>3-26</b>
<b>TRAMEC AIR VALVE</b> .....	<b>3-26</b>
<b>NEWAY AIR VALVES</b> .....	<b>3-27 TO 3-28</b>
<b>HENDRICKSON AIR VALVES</b> .....	<b>3-28 TO 3-30</b>
<b>MERITOR PSA TIRE INFLATION SYSTEM</b> .....	<b>3-31 TO 3-32</b>
<b>LISTING OF GENERIC AIR VALVES</b> .....	<b>3-32</b>

## Bracket Mount Glad Hands

	Part No.	Application	Replaces	Note
	17-14-73	Emergency	Haldex 11441 Tramec F36261	37-degree 3/8" NPTF Port with Filter
	17-14-74	Service	Haldex 11440 Tramec F36161	37-degree 3/8" NPTF Port with Filter
	700-29-480	Service	Phillips 12-136	38-degree 3/8" NPTF Port
	700-29-481	Emergency	Phillips 12-138	38-degree 3/8" NPTF Port



## Conventional Glad Hands

	Part No.	Application	Replaces	Note
	17-14-28	Emergency	Haldex 11451 Tramec 36201	Aluminum 1/2" NPTF Port
	17-14-29	Service	Haldex 11452 Tramec 36101	Aluminum 1/2" NPTF Port

## Universal Glad Hands

	Part No.	Application	Replaces	Note
	17-14-4G	Emergency Service	Haldex 11450 Tramec 36301	Aluminum 1/2" NPTF Port
	700-17-391	Emergency Service	Haldex A86300	Cast Iron 1/2" NPTF Port

## Bracket Mount Glad Hands with Valve

	Part No.	Application	Replaces	Note
	17-14-69	Service	Hebco 441000	3/8" Tubing Connector
17-14-70	Emergency	Hebco 441005	3/8" Tubing Connector	
	700-17-451	Service	Cynvalve TC-1428-2	Plastic
	700-17-452	Emergency	Cynvalve TC-1428-3	Plastic

## Swivel Glad Hands

	Part No.	Application	Replaces	Note
	17-14-79	Emergency	Tramec 36231	Cast Iron Includes 3/8" Tubing Straight Swivel Fitting
	17-14-80	Service	Tramec 36131	Cast Iron Includes 1/2" Tubing Straight Swivel Fitting

# Glad Hands

## Shut-Off Glad Hands

	Part No.	Application	Replaces	Note
	700-17-359	Service	Tramec 36151	Aluminum
	700-17-360	Emergency	Tramec 36152	Aluminum; 1/4" NPT Port for Pintle Hook
	700-17-431	Service	Tramec 36154	1/2" O.D. Tubing
	700-17-432	Emergency	Tramec 36254	1/2" O.D. Tubing

## Straight Glad Hand with Quick-Release Valve

	Part No.	Application	Replaces	Note
	17-14-99	Service	Phillips 12-206	Replaces Standard Straight Service Glad Hand

## Bracket-Mount Glad Hand with Quick-Release Valve

	Part No.	Application	Replaces	Note
	17-14-100	Service	Phillips 12-236	38-degree Angle Mount

# Glad Hand Components

## Glad Hand Pacifier

	Part No.	Replaces	Note
	700-17-400	Hebco 441721	Keeps dust particles and moisture out of glad hands when not in use

## Glad Hand Bracket

	Part No.	Replaces	Note
	700-17-188	Haldex 11403 Tramec 3420051	Clear Chromate Finish

## Dummy Glad Hand

	Part No.	Replaces	Note
	700-17-357	Haldex 11400 Tramec 3640003	Handle with 18" Cable

## Glad Hand Seals

	Part No.	Note
	700-17-17	Double Lip; Black Rubber
	700-17-75	Single Lip Compression Seal; Black Rubber
	700-17-402	Double Lip closed with Slits; Black Rubber
	700-17-405	Double Lip; Blue Urethane
	700-17-406	Double Lip; Red Urethane





## Glad Hand Grips

	Part No.	Note
	700-17-435	One Red and One Blue

## Mounting Blocks

	Part No.	Replaces	Note
	700-17-5	Haldex 26003	L.H.; Used on Nose Box 700-17-151
	700-17-6	Haldex 26004	R.H.; Used on Nose Box 700-17-151

## Mounting Brackets

	Part No.	Replaces	Note
	17-14-135	Hebco 441746	Swivel Mount
	17-17-122	Trailmobile	3/8" F.P.T.; 1/2" M.P.T.
	700-17-430	Tramec 36380	45-degree Swivel Mount
	700-17-163	Haldex 11312	3/8" F.P.T.; 1/2" M.P.T.

# Glad Hand Components

## Frame Nipples

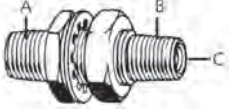
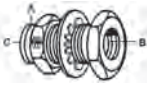
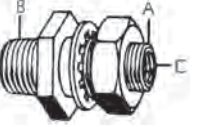
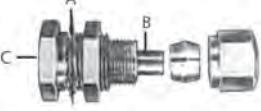
	Part No.	A	B	C	Length
	17-5-147	1/2" M.P.T.	1/2" M.P.T.	1/4" F.P.T.	2-15/16"
	WT-1346	1" -14	3/8" F.P.T.	3/8" F.P.T.	1-5/16"
	700-17-187	3/4" -16	1/2" M.P.T.	1/4" F.P.T.	1-3/4"
	17-12-351A	7/8" -20	3/8" Tube	3/8" F.P.T.	1-3/8"
	17-12-351B	7/8" -20	1/2" Tube	3/8" F.P.T.	1-3/8"

## Swivel Tubing Adapters

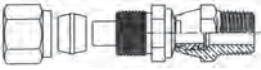
	Part No.	Note
	700-17-301	3/8" O.D. Tubing; Tramec 55243
	700-17-302	1/2" O.D. Tubing; Tramec 55244

## Glad Hand Lock

	Part No.	Note
	700-17-404	Key Number 157; Other Key Numbers Available



## Air Hose Assemblies

	Part No.	Length	Hose I.D.	A	B
	700-17-382-1	10-7/8"	1/2"	3/8" -18 Swivel	3/8" -18 Swivel
	700-17-382-2	18"			
	700-17-382-3	24"			
	700-17-382-9	26"			
	700-17-382-10	28"			
	700-17-382-4	30"			
	700-17-382-11	32"			
	700-17-382-5	36"			
	700-17-382-15	40"			
	700-17-382-6	42"			
	700-17-382-16	44"			
	700-17-382-7	48"			
	700-17-382-12	54"			
	700-17-382-13	60"			
700-17-382-14	72"				
700-17-382-17	78"				

## Slider Hose Assemblies

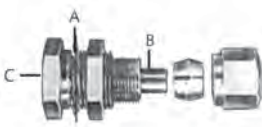
	Part No.	Length	Hose I.D.	A	B
	17-12-351-117	117"	3/8"	3/8" -18 Swivel	Bulk head fitting for 3/8" nylon tubing
	17-12-351-129	129"			
	700-17-383	117"	1/2"		Bulk head fitting WT-1346

## Bulk Air Hose

	Part No.	Length	Hose I.D.	Specification
	50-8-11	250'	3/8"	Type B, DOT106, SAEJ1402
	50-8-12		1/2"	

## Boxed Air Hose

	Part No.	Length	Hose I.D.	Specification
	50-8-24	50'	3/8"	Type B, DOT106, SAEJ1402
	50-8-16		1/2"	

# Air Hose

## Nylon Air Brake Tubing

Part No.	Tubing O.D.	Color	Length	Tubing Wall Thickness	Specifications	
17-69J-9-100	1/8"	Black	100'	.023	Type A, SAEJ844	
17-69J-9			2000'			
17-69J-1-100	1/4"		100'	.040		
17-69J-1			1000'			
17-69J-5-100	3/8"		Black	100'	.062	Type B, SAEJ844
17-69J-5				500'		
17-69J-5-R-100			Red	100'		
17-69J-5-R				500'		
17-69J-5-B-100			Blue	100'		
17-69J-5-B				500'		
17-69J-6-100		1/2"	Black	100'		
17-69J-6				500'		
17-69J-6-R-100			Red	100'		
17-69J-6-R				500'		
17-69J-6-B-100	Blue		100'			
17-69J-6-B			500'			
17-69J-7-100	5/8"		Black	100'	.092	
17-69J-7				250'		
17-69J-8-100	3/4"	100'				
17-69J-8		250'				

## Coiled Air Lines

Part No.	Working Length	Pigtail Length	Valve End Threads	Glad Hand End Threads	Tubing O.D.	Note
700-17-297	12'	2 - 6"	1/2"	1/2"	1/2"	Set
700-17-140R	15'	1 - 12"				Emergency
700-17-140B		1 - 12"	Service			
700-17-140		2 - 12"	Set			
700-17-296		2 - 12"	3/8"			Set
700-17-458		1 - 12"; 1-40"	1/2"			Set
700-17-461		1 - 12"; 1-40"				Set plus Brass Handle
700-29-491		18'	2 - 10"			

## Hose End Kits for 3/8" I.D. Rubber Hose

	Part No.	Note
	700-17-397	Two End Fittings 3/8" NPTF
	700-17-398	Two End Fittings 1/2" NPTF

## Spring Brake Chambers

	Part No.	Type	Note	Service Chamber	Emergency Chamber
	700-17-454	2424	Anchorlok Gold Seal	Clamped	Sealed
	700-17-422	2430			
	700-17-394	3030	Anchorlok Life Seal		
	700-17-419		Bendix		
	BX-800831		MGM TR Model		
	MG-3430051		MGM TR Model; 12" Rod		
	MG-3430551		MGM TR Model; Long Stroke		
	MG-3230051		Ranger Brake		
	700-17-436		3636		

Universal-type threaded rod can be cut to desired length

## Service Chambers

	Part No.	Type	Thread	Note
	17-37-36	24	Full	Ranger Brake
	700-17-291	30	Full	Ranger Brake

## Piggy Back Chambers

	Part No.	Type	Note
	700-17-418	2424	Anchorlok Gold Seal
	700-17-395	3030	
	700-17-429		Anchorlok Life Seal
	MG-3430008		MGM Plus Kit
	MG-3230008		MGM Plus Kit, Long Stroke
700-17-455	Ranger Brake Plus Kit		

## Air Chamber Diaphragms

	Part No.	Type	Diameter	Replaces
	700-17-171	9	5-1/32"	Haldex 18090
	700-17-172	12	5-15/32"	Haldex 18120
	700-17-173	16	6-5/32"	Haldex 18160
	700-17-174	20	6-17/32"	Haldex 18200
	700-17-164	24	6-31/32"	Haldex 18240
	700-17-165	30	7-27/32"	Haldex 18300
	MG-8017830	30 Long Stroke		MGM 8017830

# Air Chambers

## Clevis and Pin Assembly

	Part No.	Pin Size	Note	Thread Size
	700-17-358	1/2"	Forged	5/8"
	700-17-177		Stamped	
	700-17-370	5/8"		

## Clevis Pin

	Part No.	Diameter	Length	Replaces
	700-17-315	1/2"	1-3/8"	Haldex 19100

## Push Rod

	Part No.	Chamber Type	Replaces
	700-17-378	30	Haldex 3096038



## Dust Plug

	Part No.	Chamber Type	Replaces
	700-17-356	Haldex	Haldex M143982

## Band Clamp

	Part No.	Chamber Type	Replaces
	700-17-457	24	Anchorlok 3064004
	599-17-17C	30	Anchorlok 2464004

## Mounting Bracket

	Part No.	Application	Replaces
	7-13-35	4 x 6 Axle	Euclid E-2096 Meritor 3299-V-5299
	700-7-75	5" Round Axle	Euclid E-631 Meritor 3299-V-5300
	700-7-285		Euclid E-2681A Meritor 3299-A-5981

## Caging Bolt and Nut

	Part No.	Replaces	Note
	700-17-215	Haldex 10043	Used in manually caging emergency side

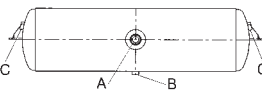
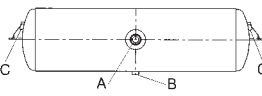
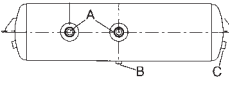
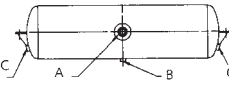
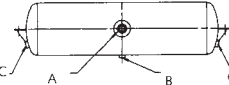
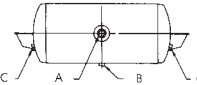
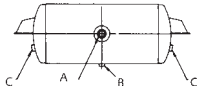
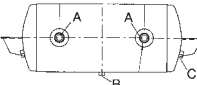
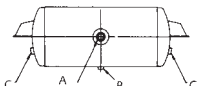
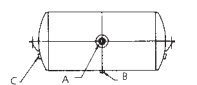
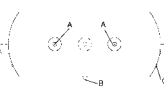
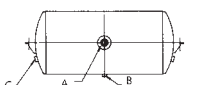
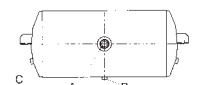
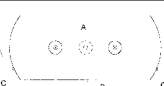
	Part No.	Diameter	Mounting Hole Centers	Cubic Capacity	Main Port A	Drain Port B	End Port C	
	*700-17-453	8"	32"	1425"	1/2" NPTF	1/4" NPTF	3/8" NPTF	
	*700-17-438							
	700-17-179			1406"	3/4" NPTF			
	*700-17-421							
	*17-8-50	9-1/2"	27-1/2"	1488"	1/2" NPTF			
	*700-17-409							
	*700-17-449							
	*700-17-439				3/4" NPTF			
	*700-17-420				1/2" NPTF			
	*17-8-55	12"	27-1/2"	2574"	3/4" NPTF			
	700-17-407		29-1/2"	2800"				
	700-17-440							
	*17-8-54		30-1/2"	2905"				



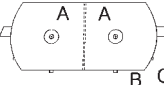

\* These tanks have an additional main port, located in the same plane, 180 degrees opposite the port shown

### Dual Compartment Air Tank

	*9017-8-13	12"	27-1/2"	2574" Total Capacity	1/2" NPTF	1/4" NPTF	3/8" NPTF
---	------------	-----	---------	-------------------------	-----------	-----------	-----------

# Hose Separators & Springs

## Hose Separators

	Part No.	Replaces	Note
	17-4-64	Haldex 11549	Used with 1/2" I.D.Hose
17-4-54	Haldex 11548		
	17-4-45	Haldex 11541	
	700-17-16	Haldex 11543	
	700-17-45	Haldex 11544	Used with 3/8" I.D. Hose

## Springs

	Part No.	Length	Replaces	Note
	700-17-7	12-1/2"	Haldex 11602	Tractor
	17-25-8	15"	Haldex 11603	Trailer Slider
	700-17-76	25-1/2"	Haldex 11600	Trailer Slider

## Spring Crossmember Clip

	Part No.
	50-B9A-84

# Nose Boxes



## Interline Nose Box Assemblies

	Part No.	Replaces	Note
	MI-BE26100	Haldex BE26100	Includes Glad Hands, 6- and 7-Way Receptacles
	MI-BE26103	Haldex BE26103	Includes Glad Hands, 6- and 7-Way Receptacles, Quicky Insert

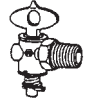

## Nose Box Housing

	Part No.	Replaces	Note
	700-17-150	Haldex B26000	Housing for MI-BE26100

## Drain Cocks

	Part No.	Note
	WT-W15310	1/4" NPTF
	WT-145	

## Drain Valves

	Part No.	Replaces	Note
	700-17-14	Tramec 35002-060V	1/4" NPTF; includes 60" Cable
	700-17-14KIT	Tramec 35013	1/4" NPTF; includes 60" Adjustable Cable

## Shutoff Valve

	Part No.	A	B
	17-3-31	1/2" NPTF	1/2" NPTF

## Pogo Sticks

### Hose-Tennas with Ring

	Part No.	Length
	700-17-25	44"
	700-17-390	40"

# Brass Fittings

## Hose Ends

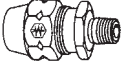
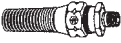
	Part No.	Hose I.D.	Pipe Thread
	WT-33806B-Y24	3/8"	1/4"
	WT-33806B-Y26		3/8"
	WT-33806B-Y28		1/2"
	WT-33808B-Y26	1/2"	3/8"
WT-33808B-Y28	1/2"		
	Part No.	Hose I.D.	Pipe Thread
	WT-33806B-Y34	3/8"	1/4"
	WT-33806B-Y36		3/8"
	WT-33806B-Y38		1/2"
	WT-33808B-Y36	1/2"	3/8"
WT-33808B-Y38	1/2"		

## Hose End Nut

	Part No.	Hose I.D.	Hex Size
	WT-33806B	3/8"	1-1/16"

## Hose End Sleeves

	Part No.	Hose I.D.
	WT-33806A	3/8"
	WT-33808A	1/2"

## Hose Unions

	Part No.	Hose I.D.
	WT-33806B-Y06	3/8"
	WT-33808B-Y08	1/2"

## Nylon Tubing Unions

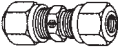
	Part No.	Tubing O.D.
	WT-1462X4	1/4"
	WT-1462X6	3/8"
	WT-1462X8	1/2"
	WT-1462X10	5/8"

## Nylon Tubing Union Tees

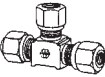
	Part No.	Tubing O.D.
	WT-1464X4	1/4"
	WT-1464X6	3/8"
	WT-1464X8	1/2"



## Nylon Tubing Male Connectors

	Part No.	Tubing O.D.	Pipe Thread
	WT-1468X4Z	1/4"	1/8"
	WT-1468X4X4Z		1/4"
	WT-1468X6X2Z	3/8"	1/8"
	WT-1468X6Z		1/4"
	WT-1468X6X6Z		3/8"
	WT-1468X6X8Z		1/2"
	WT-1468X8X4Z	1/2"	1/4"
	WT-1468X8Z		3/8"
	WT-1468X8X8Z		1/2"

## Nylon Tubing Male Branch Tees

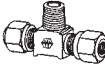
	Part No.	Tubing O.D.	Pipe Thread
	WT-1472X4Z	1/4"	1/8"
	WT-1472X6Z	3/8"	1/4"
	WT-1472X6X6X6Z		3/8"
WT-1472X8Z	1/2"		

## Nylon Tubing Male Elbows

	Part No.	Tubing O.D.	Pipe Thread
	WT-1469X4Z	1/4"	1/8"
	WT-1469X4X4Z		1/4"
	WT-1469X6X2Z	3/8"	1/8"
	WT-1469X6Z		1/4"
	WT-1469X6X6Z		3/8"
	WT-1469X6X8Z		1/2"
	WT-1469X8X4Z	1/2"	1/4"
	WT-1469X8Z		3/8"
WT-1469X8X8Z	1/2"		

## Nylon Tubing 45° Elbows

	Part No.	Tubing O.D.	Pipe Thread
	WT-1480X6Z	3/8"	1/4"
	WT-1480X6X6Z		3/8"
WT-1480X8Z	1/2"		

# Brass Fittings

## Nylon Tubing Sleeves

	Part No.	Tubing O.D.
	WT-1460X4	1/4"
	WT-1460X6	3/8"
	WT-1460X8	1/2"

## Nylon Tubing Inserts

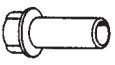
	Part No.	Tubing O.D.
	WT-2030X4	1/4"
	WT-2030X6	3/8"
	Part No.	Tubing O.D.
	WT-1484X4	1/4"
	WT-1484X6	3/8"
	WT-1484X8	1/2"
	WT-1484X10	5/8"

## Nylon Tubing Nuts

	Part No.	Tubing O.D.
	WT-1461X4	1/4"
	WT-1461X6	3/8"
	WT-1461X8	1/2"

## Copper Tubing Unions

	Part No.	Tubing O.D.
	WT-1362X4	1/4"
	WT-1362X6	3/8"
	WT-1362X8	1/2"
	WT-1362X10	5/8"

## Copper Tubing Union Tees

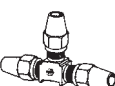
	Part No.	Tubing O.D.
	WT-1364X6	3/8"
	WT-1364X8	1/2"

## Copper Tubing Male Branch Tees

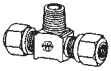
	Part No.	Tubing O.D.	Pipe Thread
	WT-1472X4Z	1/4"	1/8"
	WT-1472X6Z	3/8"	1/4"
	WT-1472X6X6X6Z		3/8"

## Copper Tubing Male Connectors

	Part No.	Tubing O.D.	Pipe Thread
	WT-1368X4Z	1/4"	1/8"
	WT-1368X4X4Z		1/4"
	WT-1368X6X2Z	3/8"	1/8"
	WT-1368X6Z		1/4"
	WT-1368X6X6Z		3/8"
	WT-1368X6X8Z	1/2"	1/2"
	WT-1368X8X4Z		1/4"
	WT-1368X8Z	1/2"	3/8"
WT-1368X10Z	5/8"		1/2"

## Copper Tubing Male Elbows

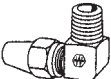
	Part No.	Tubing O.D.	Pipe Thread
	WT-1369X4Z	1/4"	1/8"
	WT-1369X4X4Z		1/4"
	WT-1369X6X2Z	3/8"	1/8"
	WT-1369X6Z		1/4"
	WT-1369X6X6Z		3/8"
	WT-1369X8X4Z	1/2"	1/4"
WT-1369X8Z	3/8"		

## Copper Tubing Sleeves

	Part No.	Tubing O.D.
	WT-1360X4	1/4"
	WT-1360X6	3/8"
	WT-1360X8	1/2"
	WT-1360X10	5/8"

## Copper Tubing Nuts

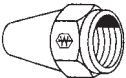
	Part No.	Tubing O.D.
	WT-1361X4	1/4"
	WT-1361X6	3/8"
	WT-1361X8	1/2"

# Brass Fittings

## Couplings

	Part No.	Pipe Thread	Hex Size
	WT-3300X2	1/8"	9/16"
	WT-3300X4	1/4"	3/4"
	WT-3300X6	3/8"	7/8"
	WT-3300X8	1/2"	1-1/16"

## Reducer Coupling

	Part No.	Pipe Thread 1	Pipe Thread 2	Hex Size
	WT-3300X6X4	3/8"	1/4"	7/8"

## Bushings

	Part No.	Pipe Thread 1	Pipe Thread 2	Hex Size
	WT-3220X4X2	1/8"	1/4"	9/16"
	WT-3220X6X2		3/8"	11/16"
	WT-3220X6X4	1/4"		
	WT-3220X8X4			3/8"
	WT-3220X8X6	1/2"		
	WT-3220X12X8	1/2"	3/4"	

## Square Head Plugs

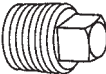
	Part No.	Pipe Thread	Square Size
	WT-3151X6	3/8"	15/32"
	WT-3151X8	1/2"	9/16"

## Hex Head Plugs

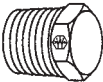
	Part No.	Pipe Thread	Hex Size
	WT-3152X2	1/8"	7/16"
	WT-3152X4	1/4"	9/16"
	WT-3152X6	3/8"	11/16"
	WT-3152X8	1/2"	7/8"

## Long Nipples

	Part No.	Pipe Thread	Length
	WT-3328X6	3/8"	2"
	WT-3328X8	1/2"	2"

## Close Nipples

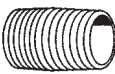
	Part No.	Pipe Thread	Length
	WT-3326X2	1/8"	3/4"
	WT-3326X4	1/4"	7/8"
	WT-3326X6	3/8"	1"
	WT-3326X8	1/2"	1-9/32"

## Hex Nipples

	Part No.	Pipe Thread	Hex Size
	WT-3325X4	1/4"	7/16"
	WT-3325X6	3/8"	11/16"
	WT-3325X6	1/2"	7/8"

## 90° Union Elbows

	Part No.	Pipe Thread 1	Pipe Thread 2
	WT-3500X4	1/4"	1/4"
	WT-3500X6	3/8"	3/8"

## 90° Street Elbows

	Part No.	Pipe Thread 1	Pipe Thread 2
	WT-3400X2	1/8"	1/8"
	WT-3400X4	1/4"	1/4"
	WT-3400X6	3/8"	3/8"
	WT-3400X8	1/2"	1/2"

## 45° Street Elbows

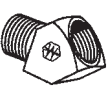
	Part No.	Pipe Thread 1	Pipe Thread 2
	WT-3350X6	3/8"	3/8"

## Adapters

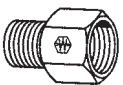
	Part No.	Pipe Thread 1	Pipe Thread 2
	WT-3200X6X4	3/8"	1/4"
	WT-3200X8X6	1/2"	3/8"

## Union Tees

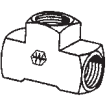
	Part No.	Pipe Thread 1	Pipe Thread 2	Pipe Thread 3
	WT-3700X2	1/8"	1/8"	1/8"
	WT-3700X4	1/4"	1/4"	1/4"
	WT-3700X6	3/8"	3/8"	3/8"

## Street Tees

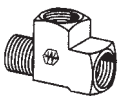
	Part No.	Pipe Thread 1	Pipe Thread 2	Pipe Thread 3
	WT-3750X4	1/4"	1/4"	1/4"

# Sealco Air Valves

## Relay Emergency Valves - Charging (4 Delivery Ports)

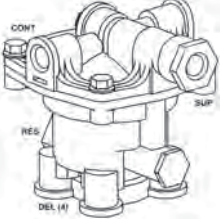
	Part No.	PORT SIZES (NPT)				Note
		Supply	Control	Reservoir	Delivery	
	SL-110200	1/4"	1/4"	3/4"	3/8"	Plug Unit Assy 110143 Major Repair Kit 110201 Spool Assembly 110162 Minor Spool Kit 110166
	SL-110205	3/8"	3/8"	3/4"	3/8"	

## Relay Emergency Valve - Non-Charging (4 Delivery Ports)

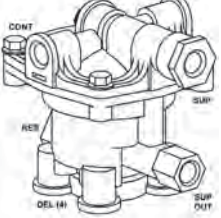
	Part No.	PORT SIZES (NPT)				Note
		Supply	Control	Reservoir	Delivery	
	SL-110338	3/8"	3/8"	3/4"	3/8"	Plug Unit Assy 110143 Major Repair Kit 110359 Spool Assembly 110162 Minor Spool Kit 110166

## Relay Emergency Valve - Pre FMVSS 121 (4 Delivery Ports)

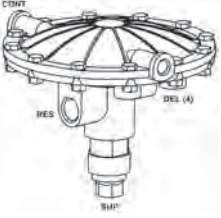
	Part No.	PORT SIZES (NPT)				Note
		Supply	Control	Reservoir	Delivery	
	SL-A1000S	1/4"	1/4"	1/2"	1/4"	Cartridge SL-10005A (Shown Right) Repair Kit 10-5

## Service Relay Valves (4 Delivery Ports)

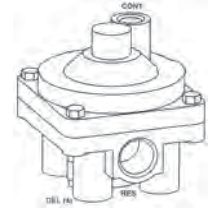
	Part No.	PORT SIZES (NPT)			Nominal Crack Pressure	Mounting Information
		Control	Reservoir	Delivery		
	SL-110380	3/8"	3/4"	3/8"	1.5 psi	Use 6003 or 6006 nipple
	SL-110415	3/8"	3/4"	3/8"	4.0 psi	

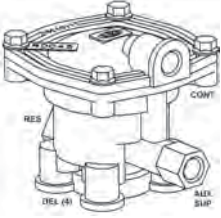
	Part No.	PORT SIZES (NPT)				Note
		Auxiliary Supply	Control	Reservoir	Delivery	
	SL-110139	3/8"	3/8"	3/4"	3/8"	Plug Unit Assy 110143 Major Repair Kit 110118

## Service Relay Valve (3 Delivery Ports)

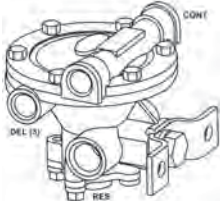
	Part No.	PORT SIZES (NPT)			Mounting Kit Included	Note
		Control (2)	Reservoir (2)	Delivery (3)		
	SL-9125	1/4"	1/2"	3/8" (2) 1/2" (1)	110237	Plug Unit Assy 9125-5 Repair Kit 912-5

## Service Relay Valves (2 Delivery Ports)

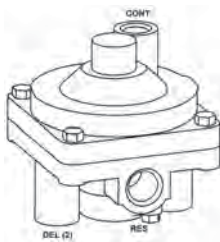
	Part No.	PORT SIZES (NPT)			Mounting Information
		Control	Reservoir	Delivery	
	SL-110360	3/8"	1/2"	3/8"	Use 6002 or 6003 Nipple
	SL-110365	3/8"	1/2"	3/8"	Frame Bracket Kit 110485 Included
	SL-110410	3/8"	1/2"	3/8"	Use 6002 or 6003 Nipple

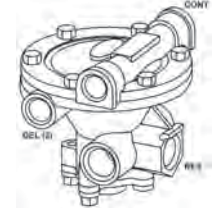
	Part No.	PORT SIZES (NPT)			Mounting Information	Note
		Control (2)	Reservoir	Delivery		
	SL-110197	3/8"	1/2"	3/8"	Use 6002 or 6003 Nipple	Plug Unit Assy 110227 Repair Kit 912-5
	SL-110198	3/8"	1/2"	3/8"	6002 Nipple Included	

## Spring Brake Control Valves – Spring Brake Priority

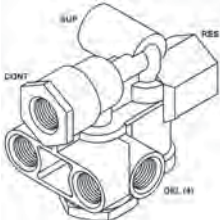
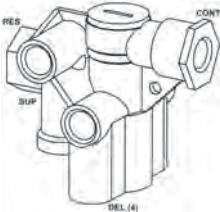
	Part No.	PORT SIZES (NPT)				Note
		Supply	Control	Reservoir	Delivery (4)	
	SL-110500	3/8"	3/8"	1/2"	3/8"	Plug Unit Assy 110515 for pressure protection; Plug Unit Assy 110520 for movable seat
	SL-110800	3/8"	3/8"	1/2"	3/8"	Plug Unit Assy 110515 for pressure protection; Plug Unit Assy 110705 for movable seat

# Sealco Air Valves

## Spring Brake Control Valves - Protected Reservoir System

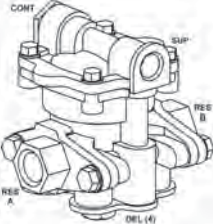
	Part No.	PORT SIZES (NPT)					Cover Picture
		Supply	Control	Reservoir A	Reservoir B	Delivery (4)	
	SL-110170	3/8"	3/8"	1/2"	1/2"	3/8"	
	SL-110310	3/8"	3/8"	3/8"	1/2"	3/8"	
	SL-110171	3/8"	3/8"	1/2"	3/8"	3/8"	
	SL-110191	3/8"	3/8"	3/8"	1/2"	3/8"	

## Control Line Valve - Dollies & Turnable Axles

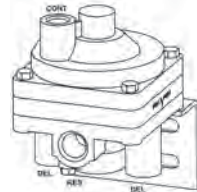
	Part No.	PORT SIZES (NPT)				Note
		Control	Reservoir	Dolly	Delivery	
	SL-110570	3/8"	1/2"	3/8"	3/8"	Includes Bracket as shown

## Control Line Valve - Trailers

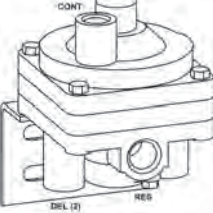
	Part No.	PORT SIZES (NPT)			Note
		Control	Reservoir	Delivery (2)	
	SL-110580	3/8"	1/2"	3/8"	Includes Bracket as shown

## Control Line Valve (Mini Valve) - Dollies

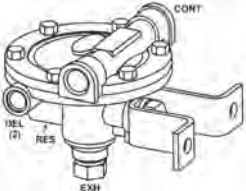
	Part No.	PORT SIZES (NPT)			Note
		Control	Reservoir	Delivery (2)	
	SL-3100	1/4"	3/8"	1/4"	Plug Unit Assy 3100-5 Rubber Repair Kit 31-5

## Manual Push - Pull Valve (Two-Hole Mounting)

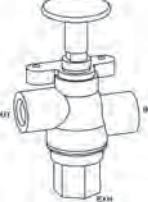
	Part No.	PORT SIZES (NPT)			Note	Name Plate
		Inlet	Outlet	Exhaust		
	SL-17600B	1/4"	1/4"	1/4"	Dolly & Trailer Park Brake Release; Black Plastic Knob; Repair Kit 176-5	



## Lever Control Valves

	Part No.	PORT SIZES (NPT)		Note	Name Plate
		Inlet	Outlet (2)		
	SL-21600	1/8"	1/8"	Repair Kit 110242	
	SL-216200				

## Pressure Control Valve

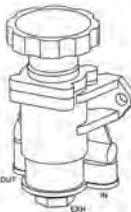
	Part No.	PORT SIZES (NPT)			Note	Name Plate
		Inlet	Outlet	Exhaust		
	SL-5400	1/4"	1/4"	1/4"	Plug Unit 5900-5 Repair Kit 59-5	

## Pressure Protection Valves

	Part No.	PORT SIZES (NPT)		Nominal Closing Pressure	Repair Kit
		Inlet	Outlet		
	SL-140270	3/8"	3/8"	60 psi	140271
	SL-140280			70 psi	140281

## Quick Release Valves

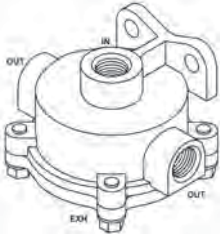
	Part No.	PORT SIZES (NPT)				Repair Kit
		Inlet	Outlet A	Outlet B	Exhaust	
	SL-200000	1/4"	1/4"	1/4"	---	20D-5
	SL-200002	1/2"	3/8"	3/8"	1/2"	

## Spring Brake Exhaust Valves

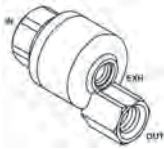
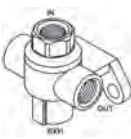
	Part No.	PORT SIZES (NPT)		DIMENSIONS		Repair Kit
		Inlet	Outlet	Height	Width	
	SL-3800	1/4"	1/4"	1-15/16"	1-9/16"	78-5
	SL-780210	3/8"	3/8"	2-1/4"	2-1/4"	

# Sealco Air Valves



## Heavy Duty Mounting Nipples



**WT-C3069X8**  
Replaces  
Sealco 6002



**PB-216P-12-8**  
Replaces  
Sealco 6003

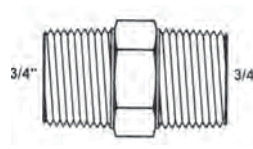

**SL-6006**

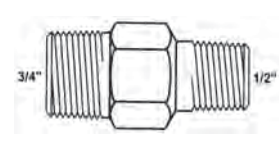

**SL-616**

## Sealco Plug Units

Quick fix for valves SL-110170, SL-110171, SL-110191

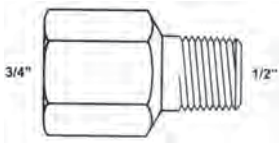

**SL-617**



**SL-110165**



**SL-110175** (Pre 10/92)  
**SL-110609** (After 10/92)

# Bendix Air Valves

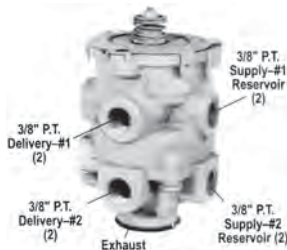

**E-6 Dual Brake Valve**  
**BX-286171**  
Generic AV-286171



**PR-4 Pressure Protection Valve**  
**BX-286500**  
Supply & Delivery Ports 1/4"



**DC-4 Double Check Valve**  
**BX-278614**  
ABC = 3/8"



**SC-3 Single Check Valve**  
**BX-800372**  
Female Inlet 1/2"  
Male Outlet 1/2"



**QRN-2 Quick Release Valve**  
**BX-800064**  
Supply & Delivery Ports 3/8"

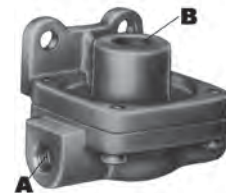

**QR-1 Quick Release Valve**  
**BX-229859**  
AB = 3/8"  
Generic AV-229859

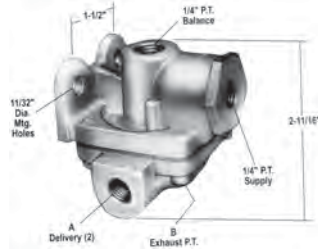

## QR-1C Quick Release Valve

**BX-289714**

A = 3/8"

Generic AV-289714

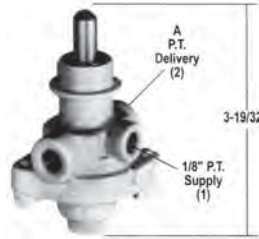

## PP-1 Control Valve

**BX-276566**

A = 1/8"

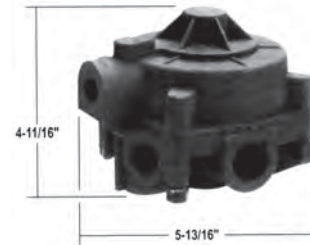

## R-8P Relay Valve

**BX-287114**

Generic AV-287114



## R-12 Relay Valves

**BX-065104**

Delivery Port = 3/8"

**BX-102626**

Delivery Port = 1/2"  
Generic AV-102626



## R-12 DuraDrain Relay Valve

**BX-800636**

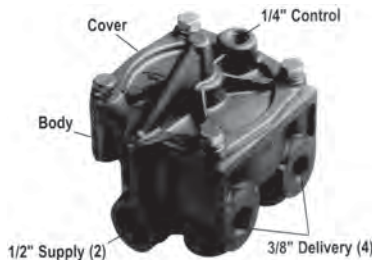

## R-12P Pilot Relay Valve

**BX-065476**

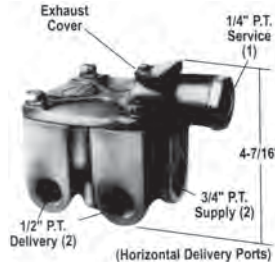

## R-14 Relay Valve

**BX-103010**

Generic AV-103010

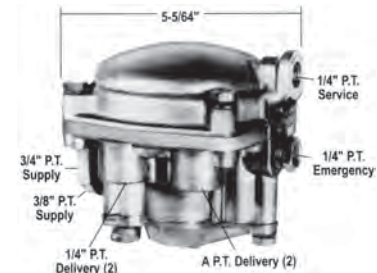

## RE-6 Relay Emergency Valve

**BX-281865**

A = 3/8"  
Generic AV-281865



## SR-5 New Configuration Trailer Spring Brake Valve

**BX-065437**

A = 3/4"

Generic AV-065437

**BX-065439**

A = 1/2"

Generic AV-065439



## MC-30 Anti-Lock ECU Valve

**BX-800737**

Note: When replacing MC-12, use BX-801696 60-in power cable with MC-30 valve

# Haldex Air Valves



## RG-2 Relay Valves

**MI-KN28510**  
Reservoir Supply &  
Delivery Port = 3/8"  
Generic AV-KN28510

**MI-KN28520**  
Reservoir Supply &  
Delivery Port = 1/2"  
Generic AV-KN28520

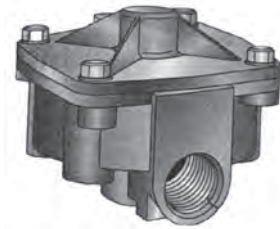

**A103600 Relay Valve**  
700-17-392



**Relay Valve**  
Generic AV-KN28060

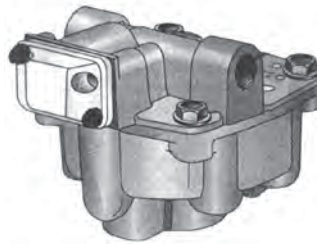

**Relay Emergency Valve**  
MI-KN30400



**RT4 Multi-Function Valve**  
MI-KN26020



## Full-Function Valves

**MI-KN28600**  
Tank Port = 3/4"  
Generic AV-KN28600

**MI-KN28601**  
Tank Port = 1/2"  
Generic AV-KN28601



**ECU Valve**  
MI-AL364040



**2S/1M ECU Replacement Kit**  
MI-AQ960510

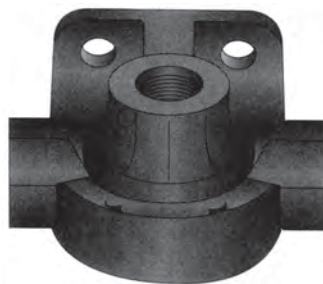

## Quick Release Valves

**MI-KN32005**

**MI-KN32011**



**Replacement Knob**  
MI-KN20903

### ECU Valves

**2S / 1M**  
RW-S4005001010

**2S / 2M**  
RW-S4005001030

### ECU Valve Kits (with adapter plug)

**2S / 1M**  
RW-R955344

**2S / 2M ; 4S / 2M**  
RW-R955320

### Relay Valves

**prior to 4-1-99**  
**(male plug)**  
RW-R955378

**4-1-99 or later**  
**(female plug)**  
RW-S4721950330



**Sensor Clip**  
RW-S8997598154



**Sensor & Clip Kit**  
RW-R955335

### Easy-Stop Power Cables

Part No.	Note
RW-S8946049440	3' long
RW-S8946060510	10' long
RW-S8946049450	13' long
RW-S8946060380	14' long
RW-S8946060500	20' long

### Enhanced Easy-Stop Power Cables

Part No.	Note
RW-S4493280300	10' long; Blunt cut
RW-S8946073130	Power 1' long; Diagnostic 10' long
RW-S4493260600	20' long

### Sensor Extension Cables

Part No.	Note
RW-S4497130180	6' long
RW-S4497130300	10' long

# Ridewell Air Valves



## Height Control Valves

**RI-6240031**  
WITH BOTTOM PORT AND  
UNIVERSAL LINKAGE KIT

**RI-6240605**  
WITH BOTTOM PLUG AND  
UNIVERSAL LINKAGE KIT

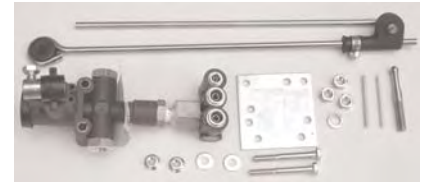

## Height Control Valve with Dump

**RI-6240013**  
WITH UNIVERSAL LINKAGE KIT

# Hadley Air Valves



## HPB450-3 Linkage Assembly

700-17-413



## H00450CE Height Control Valve

700-17-411



## H00500C Height Control Valve with Dump

700-17-412



## H00500CA Height Control Valve with Auto Dump

700-17-441

# Tramec Air Valve



## 51107 Quick Release Valve

17-7-190



**Height Control Valve  
(Controlled Response)**  
NE-90054007  
Generic AV-90054007



**Height Control Valve  
(Immediate Response)**  
NE-90554241  
Generic AV-90554241



**Height Control Valve  
with Dump  
(Immediate Response)**  
NE-90554271



**SRK168 Linkage  
Assembly**  
NE-48100225  
Use with valve NE-90054007



**SRK205 Linkage  
Assembly**  
NE-48100267  
Use with valves NE-9005424  
and NE-9055427



**Pilot Valve**  
NE-90554615  
Generic AV-90054079



**Electric Solenoid Valves**  
**(Normally Closed)**  
NE-90054074



**(Normally Open)**  
NE-90054075

**Manually Operated  
Valve**  
NE-90054088  
Generic AV-90054088



**Dump Valves**

**(Normally Closed)**  
NE-90554630

**(Normally Open)**  
NE-90554335

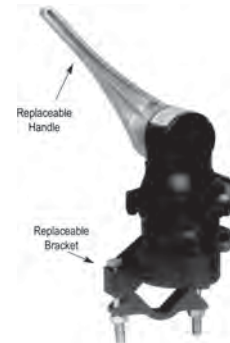

**Hand Control Valve**  
NE-90054082

# Neway Air Valves



**Pressure Protection Valve**

NE-90554107



**Sensor Valve (EDL)**

NE-90554664



**Universal Air Gauge**

NE-90054700

## Air Control Kit

Part No.	Kit Contains		
	Quantity	Part No.	Description
NE-AC-84-S-1	1	NE-90054074	Electric Solenoid Valve
	2	NE-90054615	Pilot Valve
	1	30-90044234	Decal

# Hendrickson Air Valves

## Air Control Kits

Part No.	Kit Contains		
	Quantity	Part No.	Description
HT-AK-147	1	A-14157	Manual 3-Way Valve
HT-AK-152	1	A-14568	Dial-A-Ride Package
	1	S-1129	Quick Release Valve
	1	S-14149	Pressure Protection Valve
	1	A-20417	Adaptor Kit
HT-AK-162	1	S-14149	Pressure Protection Valve
	1	B-14335	Air Kit Enclosure
HT-AK-53	1	A-24797	Solenoid Valve
HT-AK-54	1	A-2552	Pilot Valve
HT-AKH-187-3	1	VS-227	Height Control Valve
	1	S-1128	Pressure Protection Valve
HT-AKHD-203-3	1	VS-227	Height Control Valve
	1	S-1128	Pressure Protection Valve
	1	S-23460	Dump Valve





**Pilot Valve**  
HT-A-2552



**Pilot Valve**  
HT-S-24053

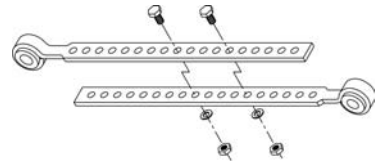

**Link Assembly  
(Bolted)**  
HT-A-14187



**Auto Dump Valve**  
HT-S-23460



**Height Control  
Valve**  
HT-VS-227



**Height Control  
Valve with Dump**  
HT-VS-27116



**Pressure Protection  
Valve**  
HT-S-1128



**Pressure Gauge**  
HT-A-14566



**Air Regulator**  
HT-A-1968



**Flipper Valve**  
HT-S-9951

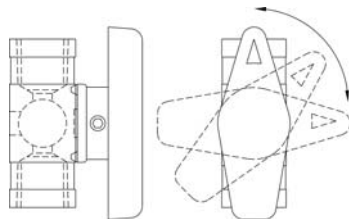

**2-Way Ball Valve**  
HT-VS-28048



**4-Way Push Pull  
Valve**  
HT-S-14179

# Hendrickson Air Valves



**Dial-A-Ride**  
HT-S-1314

## QUIK-DRAW



**3-Way Auto Reset Valve**  
HT-VS-25223



**Knob with Screw**  
HT-VS-25849



**Actuator Kit**  
HT-S-25593

## SURELOK



**Ball Valve**  
HT-VS-22535



**Bolt Kit**  
HT-S-25516



**Return Spring**  
HT-S-24495

## Tandem Retrofit Kit for TN and TQ Axles RW-31965-22

The bill of material for this retrofit kit is as follows:

Part No.	Description	Quantity	Note
32201-01-A	Press Plug Assy 1.75 with o-ring	4	Stocked as RW-32202-01-A
32631-00	Wet Wipe	4	
32621-00	Loctite 620 (10 ML)	1	
31314-21	1/4 NPT Stator/Filter Assembly	4	Stocked as RW-31314-21
31314-03	Brass Through Tee Assembly	4	1 of each of these 3 items is assembled together and stocked as Service Kit RW-31316-03
31313-16	Breather Valve (Flapper)	4	
32791-00	Deflector Shield	4	
31292-01	Press Plug Instructions	1	
31084-00	Black Control Box	1	
31072-02	Self-Locking Hex Nut	2	
31132-00	1/4 Flat Washer	3	
31152-00	1/4 Hex Cap Screw	3	
31072-01	5/16 Hex Head Cap Screw	2	
31042-00	1/8 x 1/4 TBG Compression (90)	2	
31142-00	1/4 Nylon Lock Nut	3	
31373-00	Long Flex Hose -- Inside Tire	4	Stocked as RW-31373-00
31363-00	Short Flex Hose -- Outside Tire	4	Stocked as RW-31363-00
31252-25	Cable Ties	1	
31163-00	1/4 TBG Union Tee	1	
31073-00	Control Box Bracket	1	
31052-35	1/4 Tubing 35 Ft.	1	
31023-01	Primary Pressure Protection Valve	1	
31182-75	Wiring Harness	1	
31263-06	Light Bag Assembly	1	



**Flipper Relief Valve**  
RW-31313-26



**Stator & Filter**  
RW-31314-21



**Press Plug Kit**  
RW-32202-01-A

# Meritor PSI Tire Inflation System



**Flex Hose**

**(Short for Outside Tire)**  
RW-31363-00

**(Long for Inside Tire)**  
RW-31373-00



**Brass Through Tee**

**(with Flapper & Shield)**  
RW-31316-03



**6-Hole Hub Cap PSI**

RW-32282-00  
or SM-343-4350

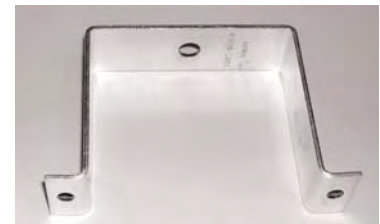

**Hubo Mounting  
Bracket PSI**

SM-610-0085

## Listing of Generic Air Valves

	Generic Part No.
Bendix	AV-065437
	AV-065439
	AV-102626
	AV-103010
	AV-229859
	AV-281865
	AV-286171
	AV-287114
	AV-289714
Neway	AV-90054007
	AV-90054079
	AV-90054088
	AV-90554241
Haldex	AV-KN28060
	AV-KN28510
	AV-KN28520
	AV-KN28600
	AV-KN28601

# Suspensions

---

<b>NEWAY SUSPENSIONS .....</b>	<b>4-1 TO 4-4</b>
<b>HENDRICKSON SUSPENSIONS .....</b>	<b>4-5 TO 4-15</b>
<b>FIRESTONE AIR SPRINGS .....</b>	<b>4-16 TO 4-17</b>
<b>GABRIEL FLEETLINE SHOCK ABSORBERS .....</b>	<b>4-18 TO 4-21</b>
<b>BINKLEY SUSPENSIONS .....</b>	<b>4-22 TO 4-25</b>
<b>HUTCH SUSPENSIONS .....</b>	<b>4-26 TO 4-41</b>
<b>TRAILMOBILE SUSPENSIONS .....</b>	<b>4-42 TO 4-47</b>
<b>FRUEHAUF SUSPENSIONS .....</b>	<b>4-48 TO 4-49</b>
<b>REYCO SUSPENSIONS .....</b>	<b>4-50 TO 4-56</b>
<b>MERITOR RHP11 SUSPENSION .....</b>	<b>4-57 TO 4-58</b>
<b>DANA RS ADVANTAGE SUSPENSION .....</b>	<b>4-58</b>
<b>U BOLTS .....</b>	<b>4-59</b>
<b>MISCELLANEOUS .....</b>	<b>4-60</b>

## Rolling Lobe Air Springs

**APPLICATION**

**NE-90557023**      **NE-90557027**      **NE-90557112**      **NE-90557113**      **NE-90557121**      **NE-90557223**      **NE-90557225**

4 THREADED HOLES ON BOTTOM      1 THREADED HOLE ON BOTTOM

AR-41	X						
AR-45	X						
AR-50-US	X						
AR-50-US-F-1		X					
AR-51	X						
AR-75-6		X					
AR-75-8		X					
AR-75-9		X					
AR-90-1-14		X		X			
AR-90-1-17		X		X			
AR-90-14			X				
AR-90-15			X				
AR-90-16			X				
AR-90-17			X				
NS190-16						X	
NS190-17							X
RL-196-15					X		
RL-196-16					X		
RL-196A-12						X	
RL-228-12						X	
RL-228-6.75						X	

## Shock Absorbers

Part No.	Travel	Extended Length	Compressed Length	Bushing Part No.
NE-90044089	7.63	21.43	13.80	NE-90508004
NE-90044162	5.36	16.89	11.53	
NE-90044625	10.95	28.06	17.11	
NE-90044626	9.07	24.30	15.23	
NE-90044642	6.95	20.07	13.12	

# Neway Air Suspensions



**Air Spring  
Mounting Plate**  
NE-90031027



**Lower Shock  
Mounting Bracket**  
NE-90519425



**Axle Beam Seat**  
NE-90001006



**Axle Adapter  
5" Round Axle**  
NE-90001082



**Axle Cap  
5" Round Axle**  
NE-90010032



**Steel Rubber Pad  
New Style**  
NE-90028083



**Rubber Wrapper  
New Style**  
NE-90028047



**Rubber Wrapper  
5" Square Axle**  
NE-90028073



**Rubber Bushing  
Front Pivot**  
NE-90008139



**Rubber Bushing  
Axle Connection**  
NE-90008149



**Alignment Block**  
NE-90001045

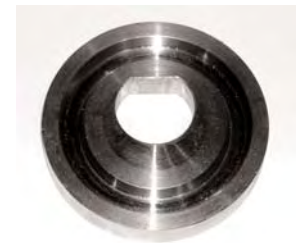

**Alignment Block**  
NE-90008186



**Alignment Bushing**  
NE-90008147



**Alignment Block & Bolt Assembly**  
NE-90508009

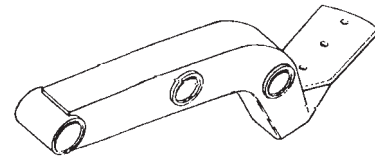

**Equalizing Beam (AR-90)**  
NE-90516112 L.H.  
NE-90516113 R.H.

### U Bolts 5" Round Axle

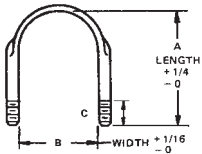
	Part No.	Size	A	B	C
	NE-90041878	1" -8	9"	6-5/16"	2-1/4"
	NE-90042791		10-1/2"		3-1/2"
	NE-90042792		12-1/2"		

### Cap Screws

Part No.	Size	Grade
NE-93201045	1-1/8" -7 x 8-1/2"	5
NE-93201051		8
NE-93201055	1-1/8" -7 x 9-1/4"	

### Flat Washers

Part No.	Size
NE-90036177	1-3/16"
NE-93900027	1"

### Lock Nut

Part No.	Size
NE-93400506	1-1/8" -7

### Service Repair Kits

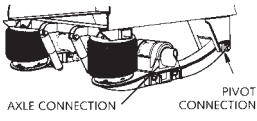
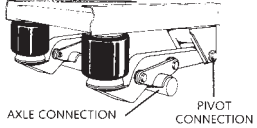
			Part No.	Description
	New Style 5" Round Axle	AR-41 AR-45 AR-75	NE-48100108 NE-48100202	SRK-64 Axle Connection SRK-145 Pivot Connection
AR-50		NE-48100108 NE-48100025	SRK-64 Axle Connection SRK-48 Pivot Connection	
	AR-90	NE-48100206 NE-48100202	SRK-149 Axle Connection SRK-145 Pivot Connection	



# Neway Spring Suspension



**Trunnion Bushing**  
NE-91008022



**Trunnion Cap**  
NE-91010047



**Trunnion Spring  
Seat Casting**  
NE-91001051

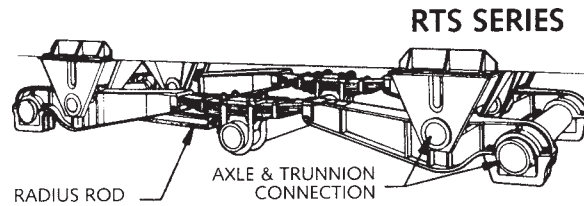

## **RTS-Series Service Repair Kits**

NE-48100033 (SRK-36 Trunnion Connection)  
NE-48100050 (SRK-39 Radius Rod Connection)

## Model HT190T

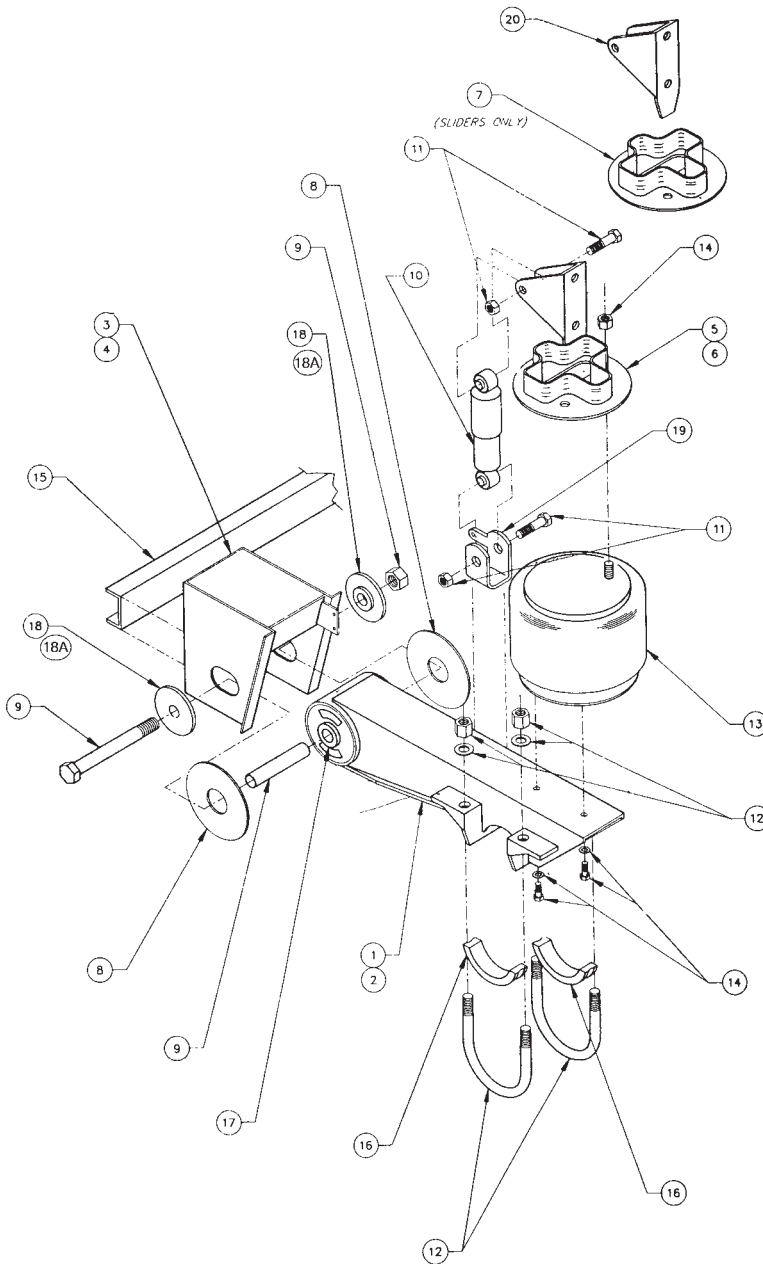

Item No.	Part No.	Description
1	HT-S-20000-1	Beam Assembly RS
2	HT-S-20000-2	Beam Assembly CS
3	Refer to Hendrickson Catalog	
4		
5		
6		
7		
8	HT-S-11613	Bushing Wear Pad
9	HT-S-3646	Pivot Bolt Kit
10	HT-S-20001	Shock Absorber
11	HT-S-20031/2	Shock Bolt Kit
12	HT-S-20032/4	U Bolt Kit
13	HT-S-20223	Air Spring
14	S-20033/2	Air Spring Bolt Kit
15	A-1631-19	Frame Bracket Channel
16	HT-S-20701	Axle Spacer
17	HT-S-6914	Tri-Functional Bushing Kit
18	HT-S-2770	Alignment Collar
18A	HT-S-220700	Alignment Collar
19	C-20030	Lower Shock Clevis
20	C-20023	Upper Shock Clevis

# Hendrickson Suspensions

## Model HK190T for K-2 Slider

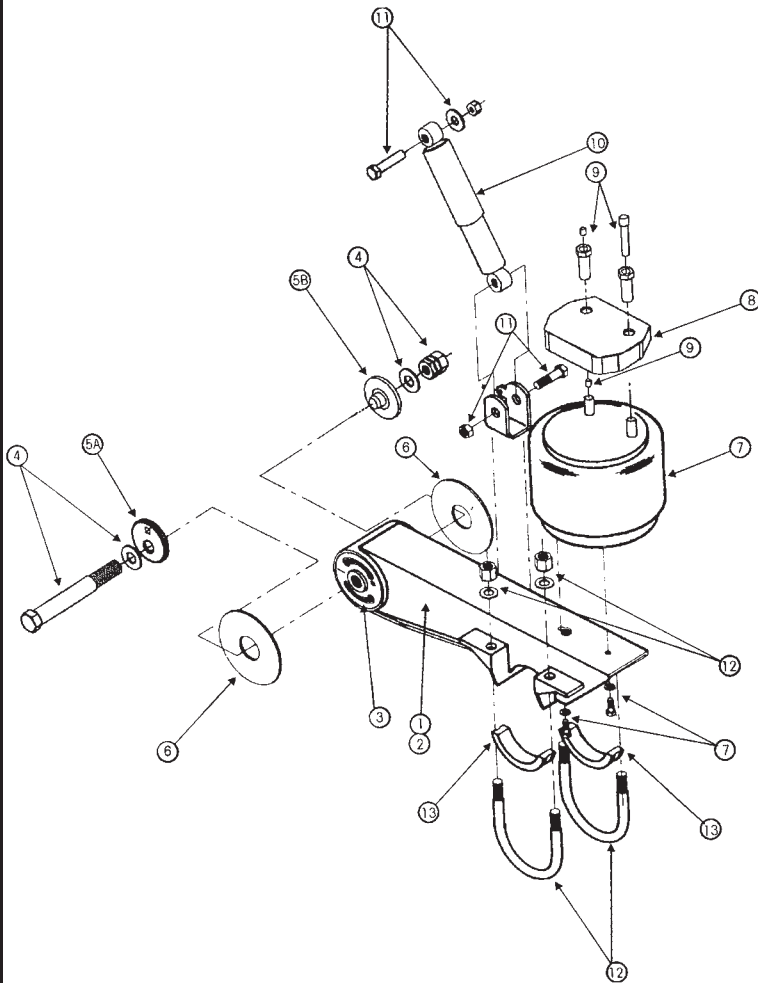

Item No.	Part No.	Description
1	HT-S-20000-1	Beam Assembly RS
2	HT-S-20000-2	Beam Assembly CS
3	HT-S-24691	Quick-Align Bushing Kit
4	HT-S-24679	Quick-Align Pivot Bolt Kit
5A	HT-S-20925	Eccentric Washer
5B	HT-S-20924	Concentric Washer
6	HT-S-11613	Bushing Wear Pad
7	HT-S-22045	Air Spring
8	Refer to Hendrickson Catalog	
9		
10	HT-S-21292	Shock Absorber
11	HT-S-20031/2	Shock Bolt Kit
12	HT-S-20032/4	U Bolt Kit
13	HT-S-20701	Axle Spacer

## Model HT230T

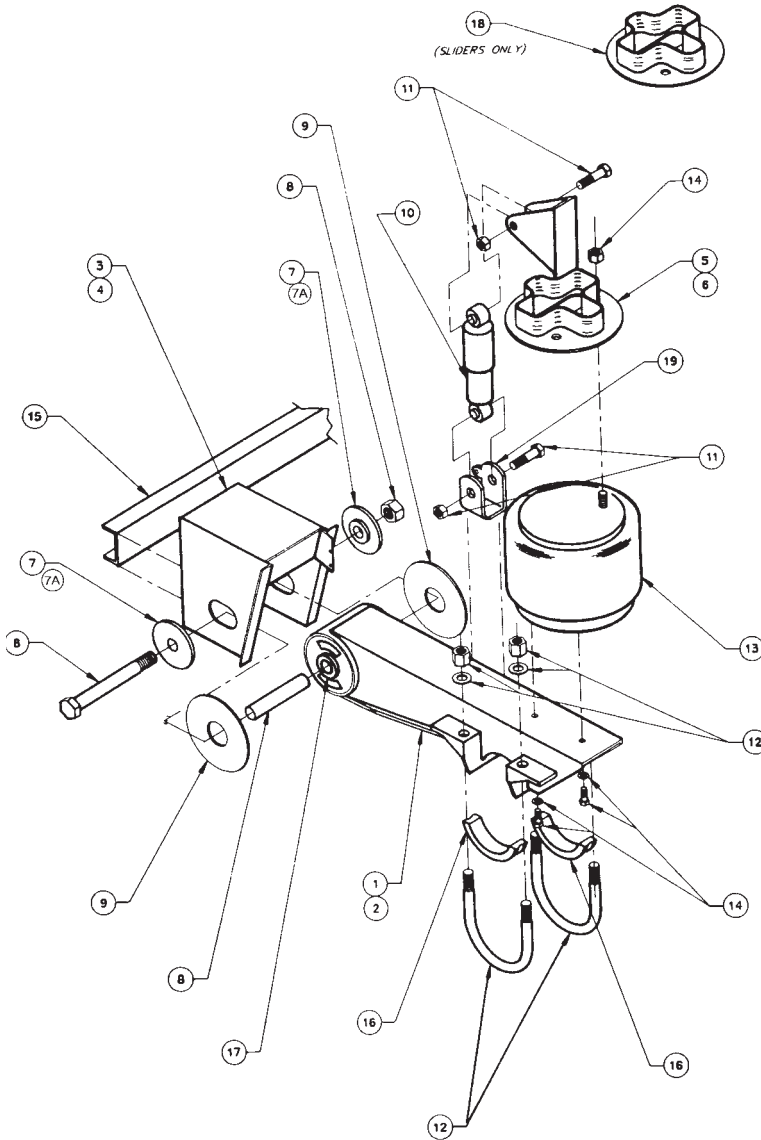

Item No.	Part No.	Description
1	HT-S-20000-1	Beam Assembly RS
2	HT-S-20000-2	Beam Assembly CS
3	Refer to Hendrickson Catalog	
4		
5		
6		
7	HT-S-2770	Alignment Collar
7A	HT-S-20700	Alignment Collar
8	HT-S-3646	Pivot Bolt Kit
9	HT-S-11613	Bushing Wear Pad
10	HT-S-20002	Shock Absorber
11	HT-S-20031	Shock Bolt Kit
12	HT-S-20032/4	U Bolt Kit
13	HT-S-20010	Air Spring
14	A-20033	Air Spring Bolt Kit
15	A-1631-39	Frame Bracket Channel
16	HT-S-20701	Axle Spacer
17	HT-S-6914	Tri-Functional Bushing Kit
18	Refer to Hendrickson Catalog	
19	HT-S-20069	Lower Shock Clevis

# Hendrickson Suspensions

## Model HK230T for K-2 Slider

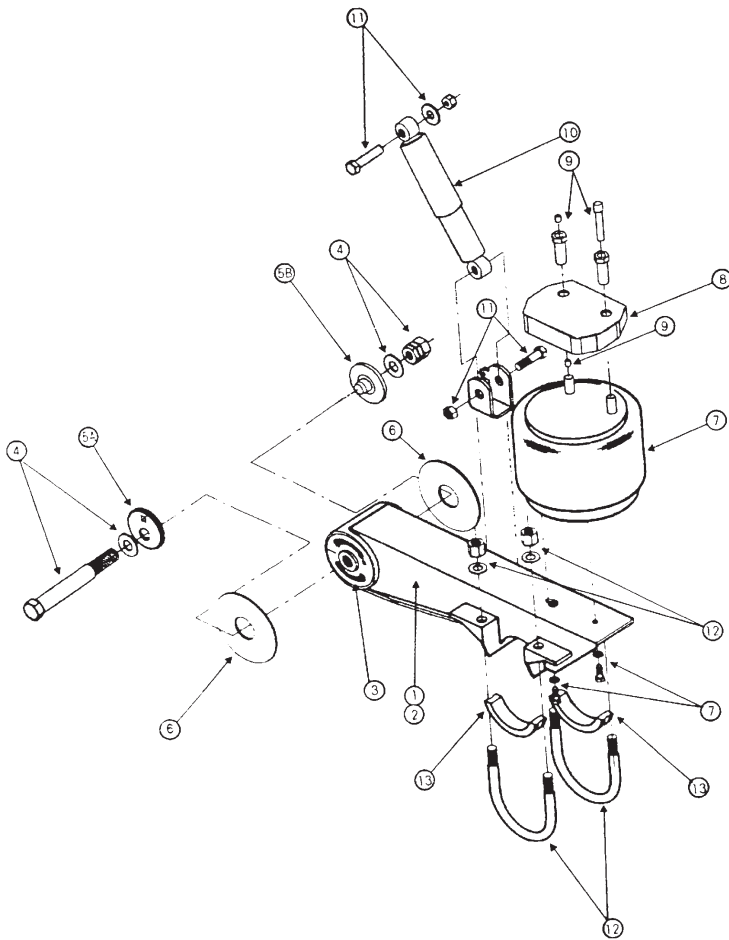

Item No.	Part No.	Description
1	HT-S-2000-1	Beam Assembly RS
2	HT-S-2000-2	Beam Assembly CS
3	HT-S-24691	Quick-Align Bushing Kit
4	HT-S-24679	Quick-Align Pivot Bolt Kit
5	HT-S-20925	Eccentric Washer
5A	HT-S-20924	Concentric Washer
6	HT-S-11613	Bushing Wear Pad
7	HT-S-22046	Air Spring
8	Refer to Hendrickson Catalog	
9	Refer to Hendrickson Catalog	
10	HT-S-21292	Shock Absorber
11	HT-S-20031/2	Shock Bolt Kit
12	HT-S-20032/4	U Bolt Kit
13	HT-S-20701	Axle Spacer

## Model HT250T

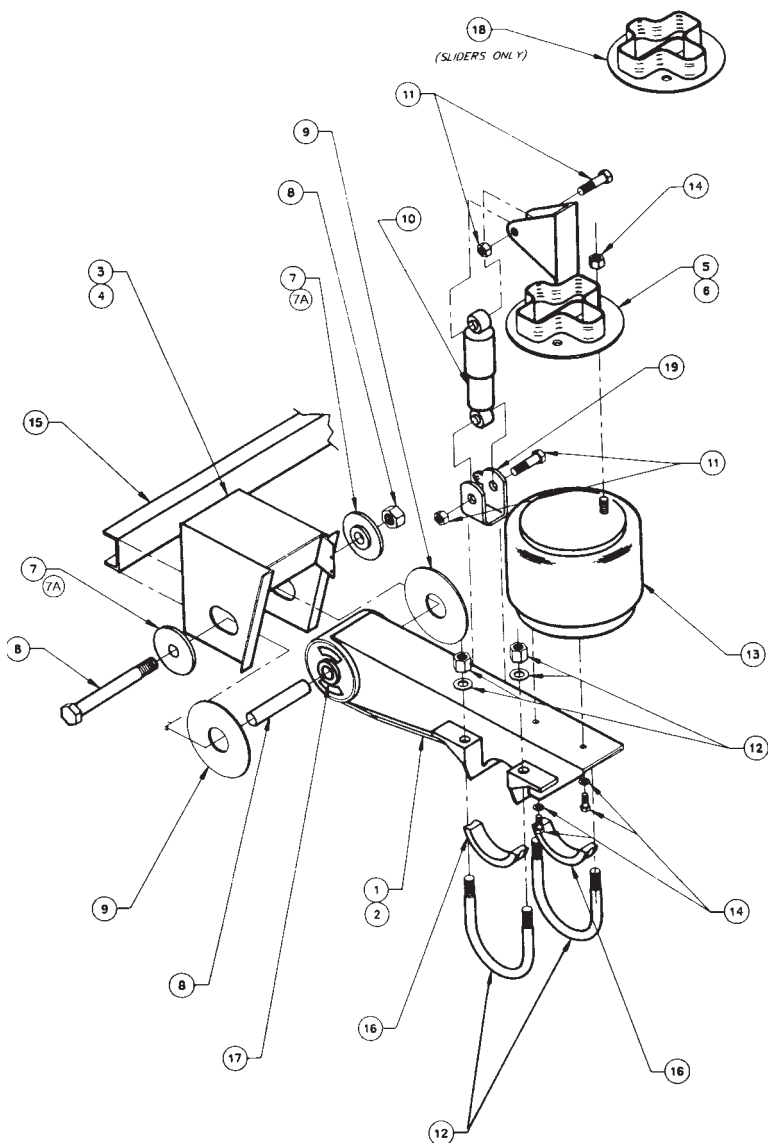

Item No.	Part No.	Description
1	D-20602-1	Beam Assembly RS
2	D-20602-2	Beam Assembly CS
3	Refer to Hendrickson Catalog	
4		
5		
6		
7	HT-S-2770	Alignment Collar
8	HT-S-11613	Bushing Wear Pad
9	S-2212	Shock Absorber
10	HT-S-20031/2	Shock Bolt Kit
11	HT-S-20032/4	U Bolt Kit
12	HT-S-20701	Axle Spacer
13	S-20033	Air Spring Bolt Kit
14	HT-S-20124	Air Spring
15	A-1631-19	Frame Bracket Channel
16	HT-S-20069	Shock Clevis
17	HT-S-6914	Tri-Functional Bushing Kit
18	HT-S-3646	Pivot Bolt Kit

# Hendrickson Suspensions

## Model HKA180 Vantraax

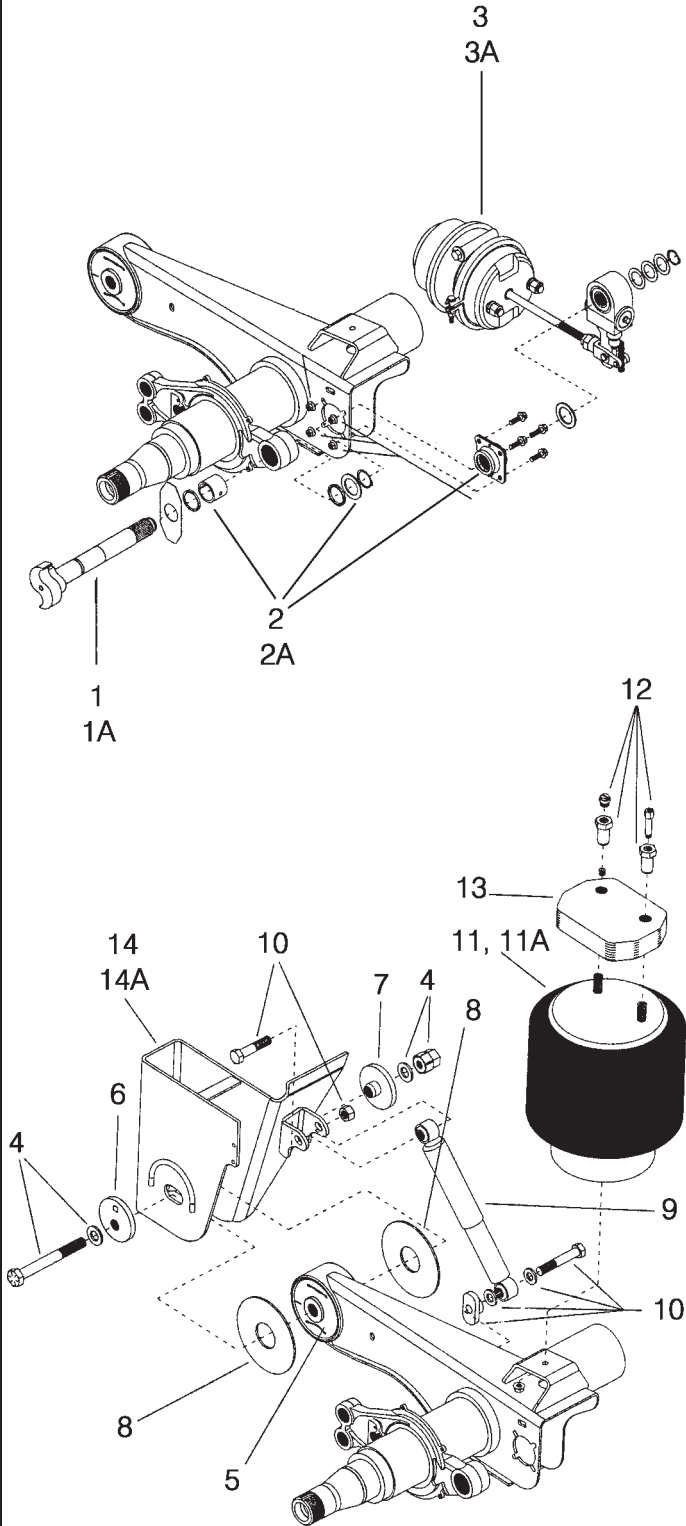

Item No.	Part No.	Description
1	HT-S-24636-1L	Camshaft
1A	HT-S-24636-1R	Camshaft
2	HT-S-23974	S-Cam Kit
2A	HT-S-21181	S-Cam Kit (Used on units shipped before 11-24-97)
3	HT-S-20837-1	Spring Brake
3A	HT-S-24247-1	Spring Brake (Long Stroke)
4	HT-S-24705	Quik-Align Pivot Bolt Kit
5	HT-S-26321	Quik-Align Bushing Kit
6	HT-S-20925	Eccentric Washer
7	HT-S-20924	Concentric Washer
8	HT-S-11613	Bushing Wear Pad
9	HT-S-24088	Shock Absorber
10	S-24049/2	Shock Bolt Kit
11	HT-S-21800	Air Spring (Below 16" Ride Height)
11A	HT-S-22948	Air Spring (From 16" to 19" Ride Height)
12		Refer to Hendrickson Catalog
13		Refer to Hendrickson Catalog
14	HT-D-22179-1	Frame Bracket RS (15-1/2" to 17" Ride Height)
14A	HT-D-22179-2	Frame Bracket CS (15-1/2" to 17" Ride Height)

## PIVOT BOLT KITS

## BUSHING KITS

### For HT190 & HT 230 without Quick-Align

#### HT-S-3646

Components	Part No.	Qty
1-1/8" -7 x 9-3/4" Bolt	B-2809	1
1-1/8" -7 Lock Nut	SA-8900-7	1
Delrin Liner	A-2068-1	1

#### HT-S-6914

Components	Part No.	Qty
Tri-Functional Bushing	C-3558	1
Pivot Bolt Kit	HT-S-3646	1
Lube Pack 2.0 oz	A-14011	1
Bushing Wear Pad	S-11613	2

### For HT190 & HT 230 with Quick-Align; Also for HKA200 & HKA250

#### HT-S-24679

Components	Part No.	Qty
Hardened Steel Washer	A-21024	2
Heavy Hexnut	A-23583	1
Shear-Type Bolt	B-23582-1	1
Decal	L-688	1

#### HT-S-24691

Components	Part No.	Qty
Pivot Bushing	C-21824	1
Pivot Bolt Kit	HT-S-24679	1
Lube Pack 2.0 oz	A-14011	1
Bushing Tube Spacer	B-11613	3

#### HT-S-24680

Components	Part No.	Qty
Hardened Steel Washer	A-21024	2
Heavy Hexnut	A-23583	1
Shear-Type Bolt	B-23582-1	1
Inner Washer	C-20924	1
Eccentric Washer	C-20925	1
Decal	L-688	1

### For HKA180

#### HT-S-24705

Components	Part No.	Qty
Hardened Steel Washer	A-21024	2
Heavy Hexnut	A-23583	1
Shear-Type Bolt	B-23582-1	1
Decal	L-688	1

#### HT-S-26321

Components	Part No.	Qty
Pivot Bushing	D-25364	2
Pivot Bolt Kit	HT-S-24705	1
Lube Pack 2.0 oz	A-14011	1
Bushing Tube Spacer	B-26807	4



# Hendrickson Suspensions

## U Bolt Kits

### HT-S-20032/4

Components	Part No.	Qty
7/8" x 8-3/16" Round U Bolt	SA-1200-47	1
7/8" Hi Nut	SA-1300-1	2
7/8" Flat Washer	SA-1500-1	2

### HT-S-3650/4

Components	Part No.	Qty
7/8" x 8-5/8" Round U Bolt	SA-1200-12	1
7/8" Hi Nut	SA-1300-1	2
7/8" Flat Washer	SA-1500-1	2

## Frame Brackets

Part No.	Roadside / Curbside	Application
HT-C-20064-1	RS	HT190 / 230; 14" & 15" Ride Height HT250T; 12", 14" & 15" Ride Height
HT-C-20064-2	CS	
HT-D-21179-1	RS	HT190TA / 230TA / 250TA 14" & 15" Ride Height
HT-D-21179-2	CS	
HT-D-21291-1	RS	HT190 / 230 16" Ride Height; K2 Slider
HT-D-21291-2	CS	
HT-D-21497-1	RS	HT190 / 230 17" Ride Height; K2 Slider
HT-D-21497-1	CS	
HT-D-21808-1	RS	HKA200C 16" & 17" Ride Height
HT-D-21808-1	CS	
HT-D-22179-1	RS	HKA180 15.5" to 17" Ride Height
HT-D-22179-2	CS	

## Shocks & Shock Strap Kits

Shock	Shock Strap Kit
HT-S-20001	HT-S-14587-1
HT-S-20002	HT-S-14587-1
HT-S-20126	HT-S-14587-8
HT-S-21292	S-14587-9
HT-S-2160	S-14587-2
HT-S-23566	HT-C-23086-1
HT-S-23649	C-23086-5
HT-S-23650	C-23086-3
HT-S-24088	HT-C-23086-1

## Shock Bolt Kits

Part No.	Application
HT-S-24021	HKA200 / 250
HT-S-24024	HT250US
HT-S-24049/2	HKA180
HT-S-20031/2	HT190T / 230T

## Surelok

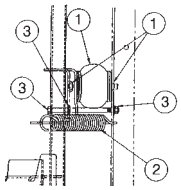
	Item No.	Part No.	Description
	1	HT-S-25593	Actuator Assembly
	2	HT-S-24495	Spring 1.27 x 4.40 x 0.128
	3	HT-S-25516	Restraint Bolt Kit

## Slider Rail Clamps

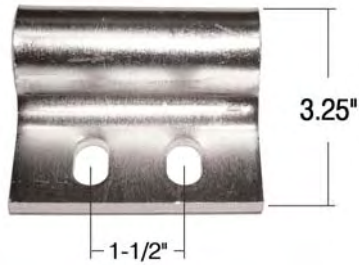

**HT-S-14108**

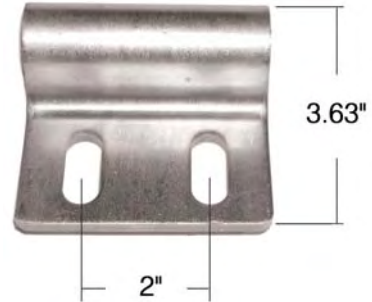

**HT-S-22366**

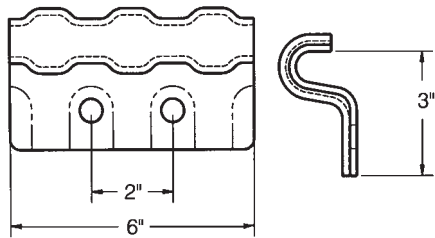

**HT-S-24459**

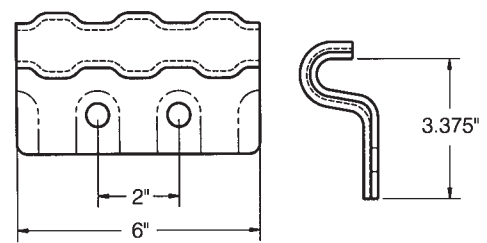

**HT-S-24460**

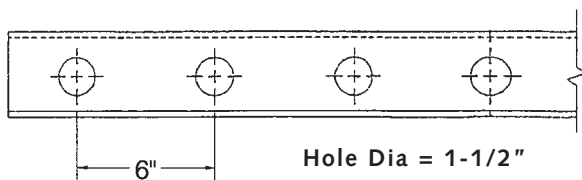

**Slider Rail**  
**HT-RAILE-198**

# Hendrickson Suspensions



## Subframes

Part No.	Mates with these Slider Rails	For these Suspensions	Pin Size	Hole Centers	Ride Height
HT-AMBOX.24	Binkley and Hendrickson	HK190T / 230T	1-3/8"	6"	16"
HT-AMBOX.48	Hutch		1-5/8"	4"	
HT-AMBOX.93		HKA180			17"
HT-AMBOX.81					16"

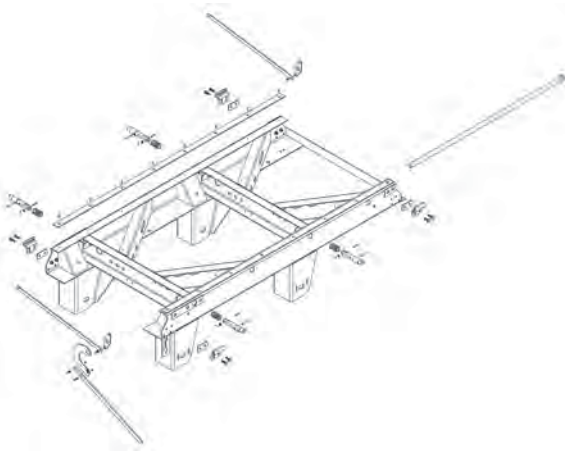

HT-AMBOX.24

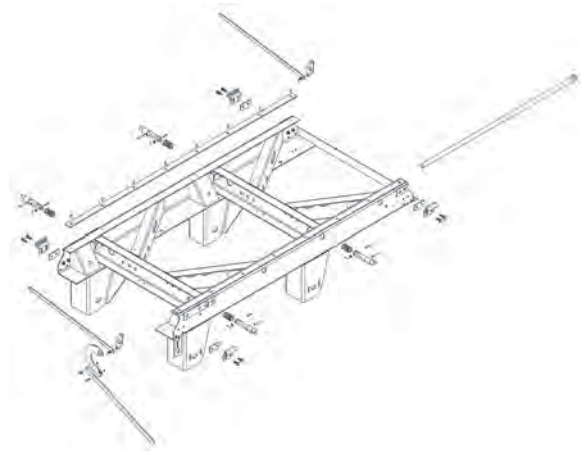

HT-AMBOX.48

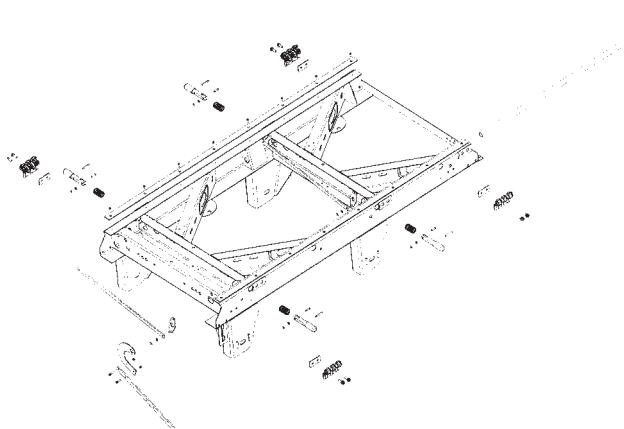

HT-AMBOX.81

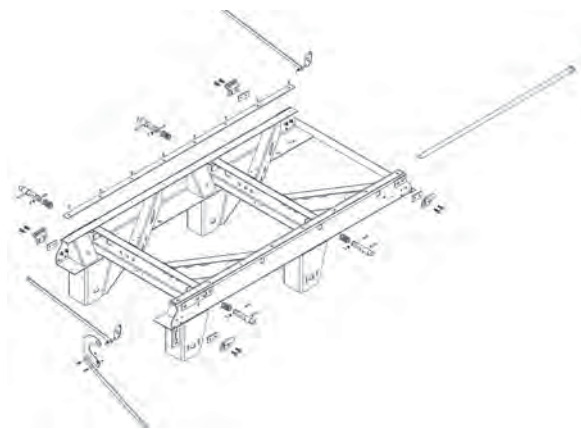

HT-AMBOX.93

## Stop Bars



**HT-S-14231-8**  
48" Box  
6" Hole Centers

**HT-S-21477-8**  
48" Box  
4" Hole Centers

## Air Springs

HT-S-20010	HT-S-21800
HT-S-20124	HT-S-21966
HT-S-20127	HT-S-22045
HT-S-20217	HT-S-22046
HT-S-20223	HT-S-22948
HT-S-21784	

## HS Slider (6" Hole Centers)

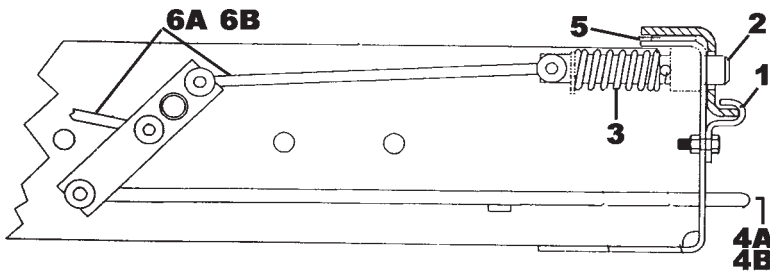

Item No.	Part No.	Description
1	HT-S-14108	Body Rail Clip
2	HT-S-14104	Locking Pin
3	HT-S-14102	Compression Spring
4A	S-14111-2	Actuator Arm 42" Box
4B	S-14111-1	Actuator Arm 48" Box
5	HT-S-14342-1	Wear Pad
6A	S-14112-2	Locking Pin Link 42" Box
6B	S-14112-1	Locking Pin Link 48" Box

## K-2 Slider

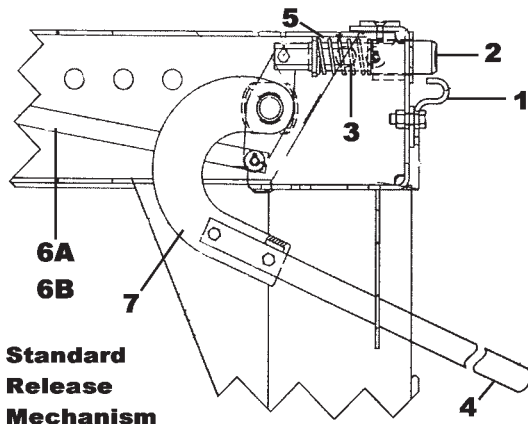

Item No.	Part No.	Description
1	Contact Sales	
2A	B-25262	Locking Pin 1-3/8"
2B	HT-B-25261	Locking Pin 1-5/8"
3	HT-B-23165	Compression Spring
4	HT-B-21505	Handle
5	HT-S-14342-3	Wear Pad Kit
6A	S-23150-1	Locking Pin Link 42" Box
6B	S-23150-2	Locking Pin Link 48" Box
7	S-23232	Handle Mount

# Firestone Air Springs



## Triple Convoluted Style

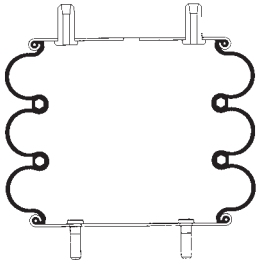

FS-7798  
 FS-7808  
 FS-7843  
 FS-7850  
 FS-8018  
 FS-8033

## Double Convoluted Style

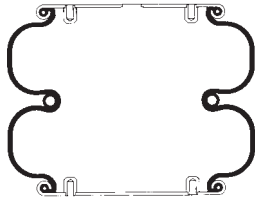

FS-6801	FS-6944	FS-7403
FS-6897	FS-7135	FS-7410
FS-6902	FS-7136	FS-7443
FS-6905	FS-7140	FS-7545
FS-6935	FS-7145	FS-7555
FS-6943	FS-7400	FS-7795

## IT - Reversible Sleeve Style

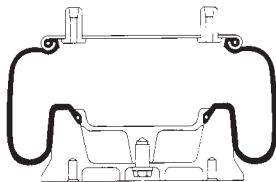

FS-8050	FS-9130	FS-9366
FS-8203	FS-9158	FS-9367
FS-8204	FS-9177	FS-9370
FS-8901	FS-9192	FS-9371
FS-9033	FS-9213	FS-9394
FS-9039	FS-9219	FS-9422
FS-9069	FS-9241	FS-9466
FS-9082	FS-9264	FS-9619
FS-9083	FS-9265	FS-9640
FS-9101	FS-9270	FS-9648
FS-9105	FS-9293	FS-9780
FS-9121	FS-9320	FS-9921
FS-9122	FS-9321	FS-9922

## Goodyear Cross to Stocked Firestone

Goodyear	Firestone
1R11-028	FS-9422
1R12-066	FS-9083
1R12-069	FS-9069
1R12-090	FS-9213
1R12-092	FS-9082
1R12-095	FS-9039
1R12-103	FS-9101
1R12-132	FS-9105
1R12-142	FS-9241
1R12-167	FS-9192
1R12-182	FS-9219
1R12-256	FS-9321
1R12-279	FS-9394
1R12-281	FS-9130
1R12-303	FS-9780
1R12-351	FS-9033
1R12-363	FS-9320
1R12-365	FS-9466

Goodyear	Firestone
1R12-367	FS-9640
1R12-375	FS-9265
1R12-401	FS-9371
1R12-487	FS-9366
1R12-501	FS-9293
1R12-503	FS-9370
1R13-038	FS-9122
1R13-039	FS-9121
1R13-119	FS-9270
1R14-028	FS-9177
1R14-030	FS-9158
1R14-039	FS-8050
1R14-127	FS-9264
2B10-226	FS-7795
2B12-305	FS-7443
2B12-307	FS-7403
2B12-309	FS-7400
2B12-406	FS-7410

Goodyear	Firestone
2B12-406	FS-7545
2B12-440	FS-7555
2B14-354	FS-7145
2B14-356	FS-7136
2B14-359	FS-7140
2B14-360	FS-7135
2B14-365	FS-6801
2B9-201	FS-6902
2B9-201	FS-6935
2B9-206	FS-6905
2B9-250	FS-6943
2B9-252	FS-6944
3B12-303	FS-8018
3B14-354	FS-7808
3B14-356	FS-7798
3B14-364	FS-7843
3B14-452	FS-7850

## Hendrickson Cross to Stocked Firestone

Hendrickson	Firestone
S-20010	FS-9270
S-20124	FS-9265
S-20223	FS-9640

## Neway Cross to Stocked Firestone

Neway	Firestone
90557023	FS-9039
90557027	FS-9082
90557223	FS-8204
90557225	FS-9366

# Gabriel FLEETLINE Shock Absorbers

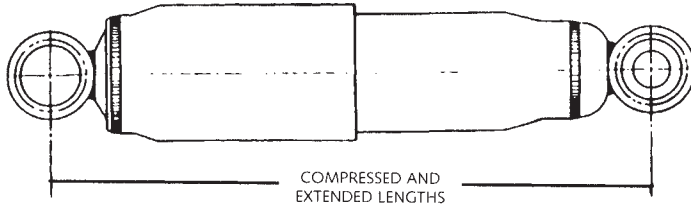

EyeRing/Bushing & Sleeve

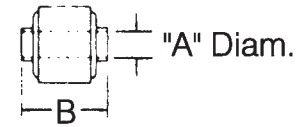

Part No.	Stroke	Extended Length	Compressed Length	A	B
GB-646155	8.35	22.45	14.40	3/4"	1-3/4"
GB-83122	9.49	25.24	15.75		
GB-83123	10.24	26.62	16.38		
GB-83125	10.99	28.12	17.13		
GB-83130	5.99	17.99	12.01		
GB-83203	5.74	17.10	11.36		
GB-83204	7.28	20.14	12.86		
GB-83207	8.03	21.64	13.61		
GB-83209	12.03	29.64	17.61		
GB-83221	9.28	24.01	14.73		
GB-85000	5.76	17.22	11.46		
GB-85013	12.03	29.74	17.71		
GB-85030	9.16	24.00	14.84		
GB-85036	10.08	26.38	16.29		

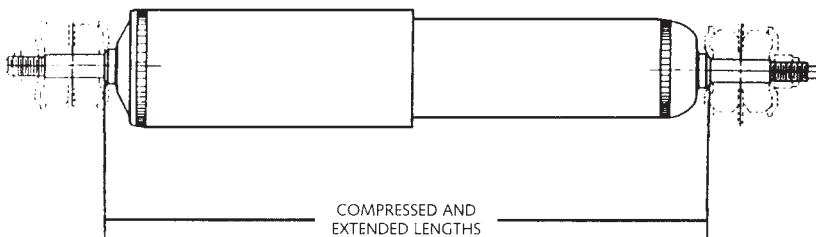

STRAIGHT STEM

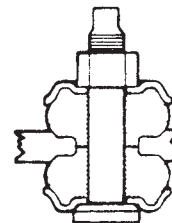

Part No.	Stroke	Extended Length	Compressed Length
GB-83102	9.50	23.00	13.50
GB-85310	6.91	18.65	11.74

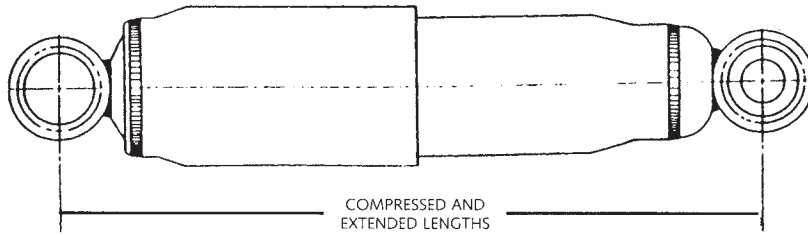

EyeRing & Bushing

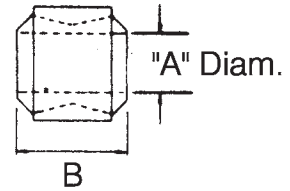

GB-83309	11.53	28.64	17.11	3/4"	1-3/4"
GB-85012	7.78	20.99	13.21		
GB-85023	7.28	20.24	12.96		
GB-85046	10.91	27.51	16.60		
GB-85047	9.78	25.25	15.47		

EyeRing & Bushing

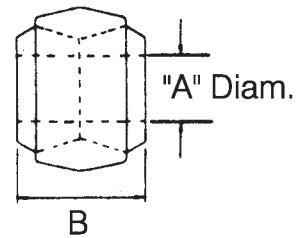
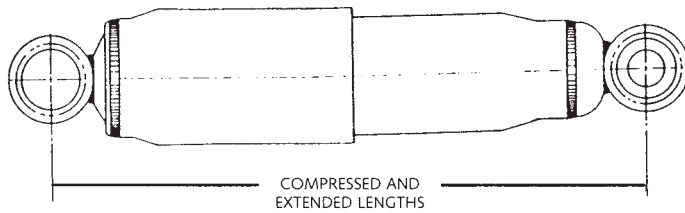

Part No.	Stroke	Extended Length	Compressed Length	A	B
GB-85001	9.91	26.33	16.42	1"	1.91"
GB-85300	5.78	18.00	12.22		
GB-85302	8.03	22.75	14.72		
GB-85320	9.78	26.13	16.35		



# Gabriel FLEETLINE Shock Absorbers

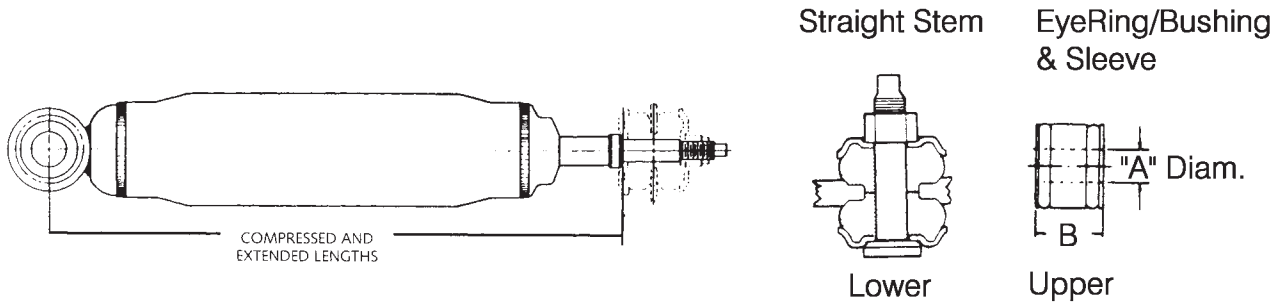

Part No.	Stroke	Extended Length	Compressed Length	A Upper	B Upper
GB-85026	9.03	23.00	13.97	5/8"	1.75"

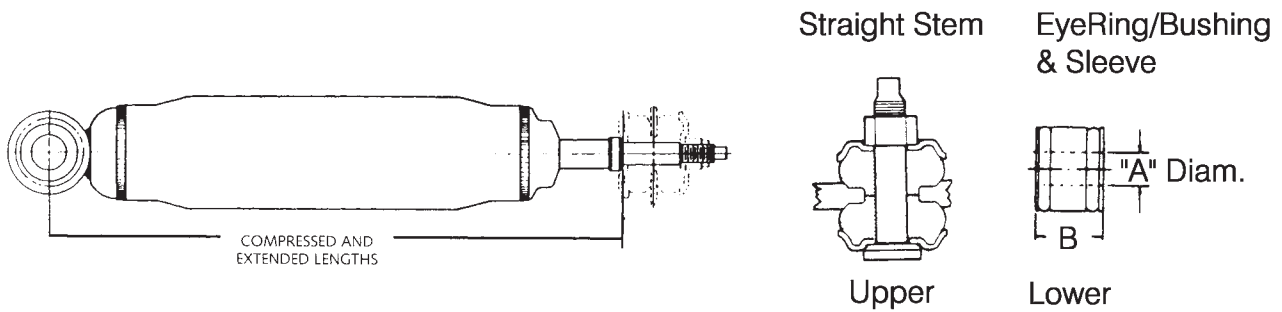

Part No.	Stroke	Extended Length	Compressed Length	A Lower	B Lower
GB-85316	7.76	20.61	12.85	3/4"	1-3/4"
GB-85319	8.28	22.20	13.92		2.24"

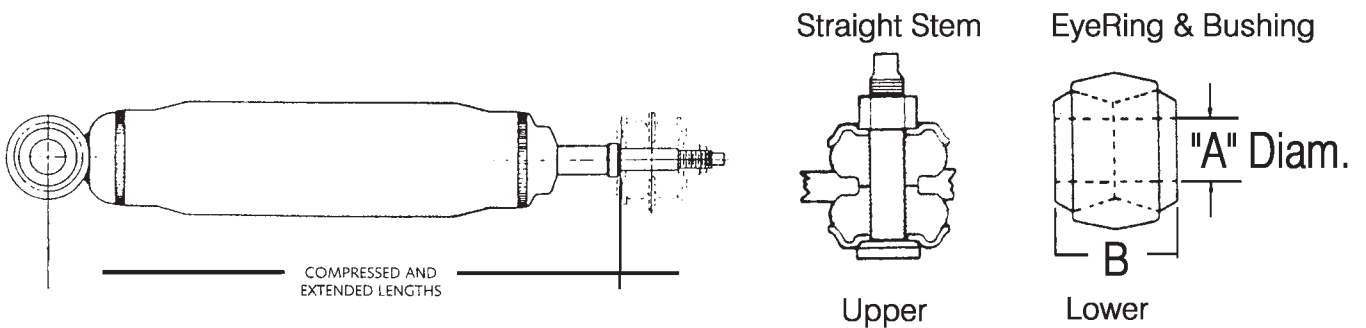

Part No.	Stroke	Extended Length	Compressed Length	A	B
GB-85033	9.84	27.21	17.37	1"	1.91"
GB-85311	9.16	23.95	14.79		

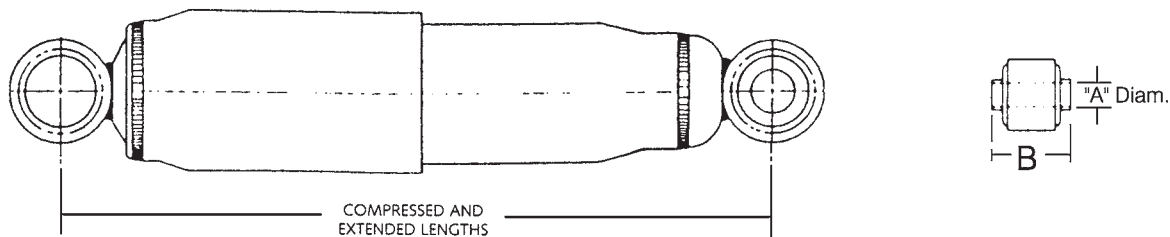

Part No.	Stroke	Extended Length	Compressed Length	A	B
GB-85003	9.78	25.37	15.59	5/8"	2"
GB-85061	9.53	24.75	15.22		2.60"

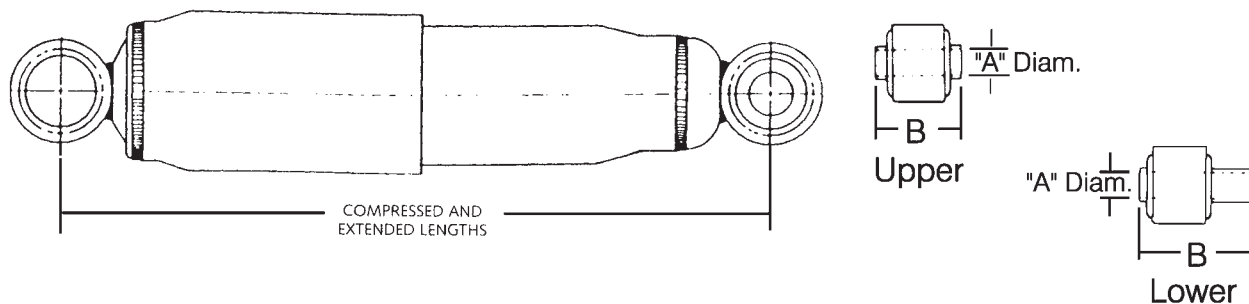

Part No.	Stroke	Extended Length	Compressed Length	A Upper	B Upper
GB-85724	8.28	22.78	14.50	3/4"	3.80"
				A Lower	B Lower
				3/4"	3.21"

# Binkley Suspensions

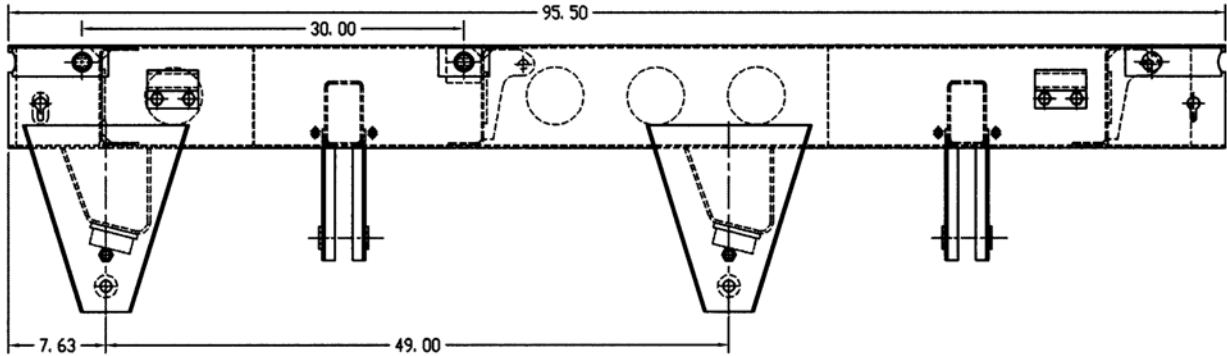

## AirLite2 Replacement Subframe Assembly

**BK-SL0A1280-S8**

48" Frame Width

To mate with Binkley Slider Rails

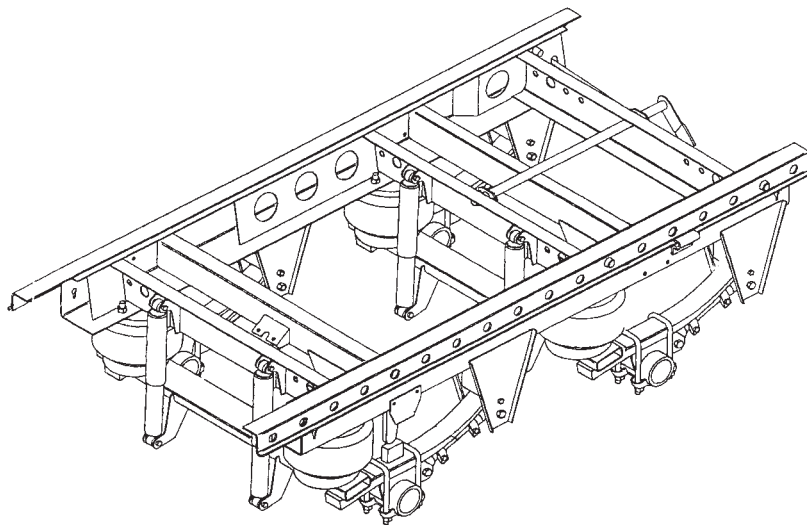

## AirLite2 Retro-Fit Kit

**For conversion from Spring Ride to Full Air Ride**

**BK-AL24R8NH000NN007**

48" Frame Width

To mate with Hutch Slider Rails

Kit contains Height Control Valve with Manual Dump

Kit does not contain Spring Seats or U Bolts

## AirLite2 Replacement Parts

**Air Spring**  
BK-XB-SPN-053-60  
or FS-8204

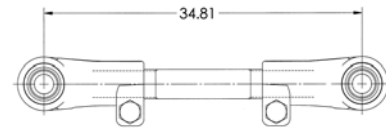
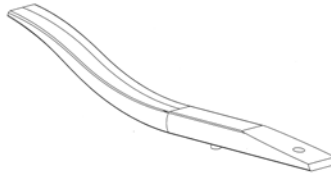

**Shock Absorber**  
GB-83125

**Spring Beam**  
BK-XB-SP0205-01

**Cross Arm**  
BK-SP0202-10

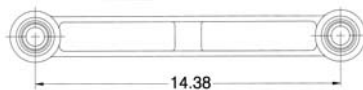
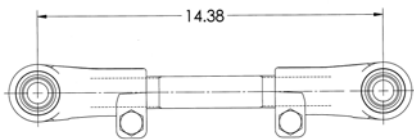

**Torque Arm Bolt**  
BK-PP0050-75

**Adjustable  
Torque Arm**  
BK-SP0202-01

**Non-Adjustable  
Torque Arm**  
BK-SP0224



**Torque Arm Nut**  
BK-PP0012-36

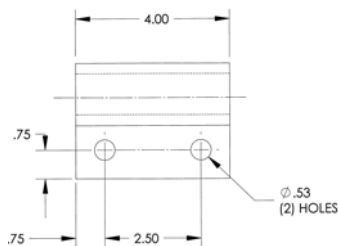

**Hold Down Clip**  
BK-SL0893

## Lite-Slide Replacement Parts

**Pull Arm**  
BK-SL0744-07  
48" Width

**Lock Pin**  
BK-SL0450  
1-3/8"

**Compression Spring**  
BK-XB-SPG020-18

**Hold Down Clamp**  
BK-SL0893

# Binkley Suspensions



**Manual Stop Bar**  
BK-SL0502-48  
48" Frame Width



**Quick Release Handles**  
BK-SL0724-42  
BK-SL0724-48  
Van Sliders

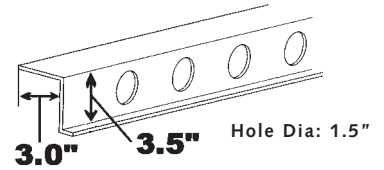

**Body Rail**  
BK-SL0853-40  
240" Length  
6" Hole Centers  
Van Sliders



**Front Hanger**  
BK-SP0100  
Straddle Mount



**Equalizer Hanger**  
BK-SP0110  
Straddle Mount



**Rear Hanger**  
BK-SP0120  
Straddle Mount



**Front Hanger**  
BK-SP0162  
Under Mount



**Equalizer Hanger**  
BK-SP0161  
Under Mount



**Rear Hanger**  
BK-SP0160  
Under Mount



**Equalizer with Bushing**  
BK-SP0131



**Equalizer Bolt**  
BK-PP0050-73  
1" -12 x 6-1/2"



**Flange Lock Nut**  
BK-PP0012-37  
1" -12



**Adjustable  
Torque Arm**

**BK-SP0123**

19-1/4" with Bushings



**Non-Adjustable  
Torque Arm**

**BK-SP0143**

19-1/4" with Bushings

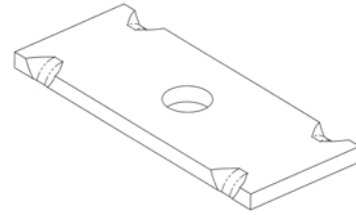

**Top Plate**

**BK-SP0178**

Flat Top U Bolts



**Torque Arm Bolt**

**BK-PP0050-75**

7/8" -14 x 4-3/4"



**Flange Lock Nut**

**BK-PP0012-36**

7/8" -14



**Bottom Plate**

**BK-SP0099**

5" Round Axle



**Spring Seats**

5" Round Axle

Part No.	Height
BK-SP0142-01	3/4"
BK-SP0142-02	1-1/4"
BK-SP0142-03	1-3/4"
BK-SP0149-04	2-1/4"
BK-SP0149-05	2-3/4"

# Hutch Suspensions

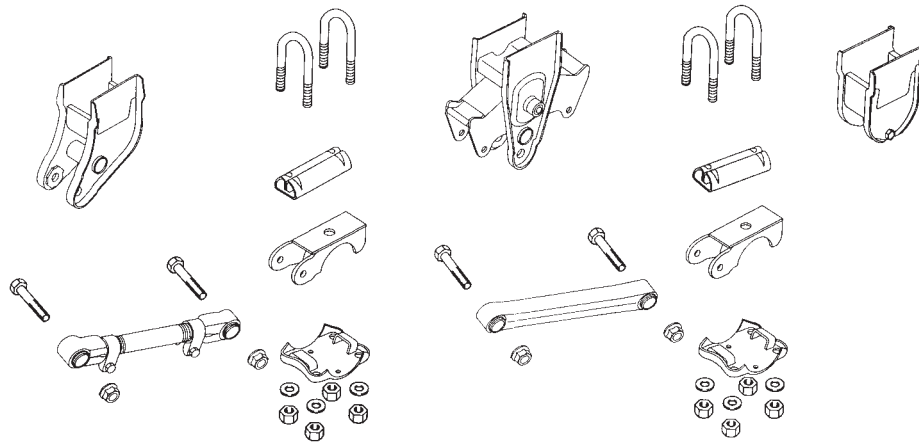

## 9700 Suspension Kits

Part No.	Type Hanger	Remarks	Type Axle	Spring Width	Spring Seat Height
HU-9700S-3/4-STM	Straddle Mount	Fabricated Single	5" Round	3"	3/4"
HU-9700MAC-3/4-STM		Fabricated MAC			
HU-9700S-3/4-UM	Under Mount	Fabricated Single			
HU-9700MAC-3/4-UM		Fabricated MAC			
HU-9700S-3/4-UM-US		Fabricated Single; Underslung			
HU-9700MAC-3/4-UM-US		Fabricated MAC; Underslung			

Single Axle Suspension		Tandem Axle Suspension		Tri-Axle Suspension	
Kit	Qty	Kit	Qty	Kit	Qty
HU-9700S	1	HU-9700S	1	HU-9700S	1
		HU-9700MAC	1	HU-9700MAC	2

### 9700 MAC Kit includes:

Qty	Description
2	Hanger Rocker Assemblies
1	Adjustable Torque Arm
1	Non-Adjustable Torque Arm
2	Spring Seats
2	Bottom Plates
2	Top Plates
4	U Bolts
2	Bump Out Blocks
	Attaching Hardware

### Notes:

Springs are not included in suspension kits

Illustration above is for a tandem axle suspension

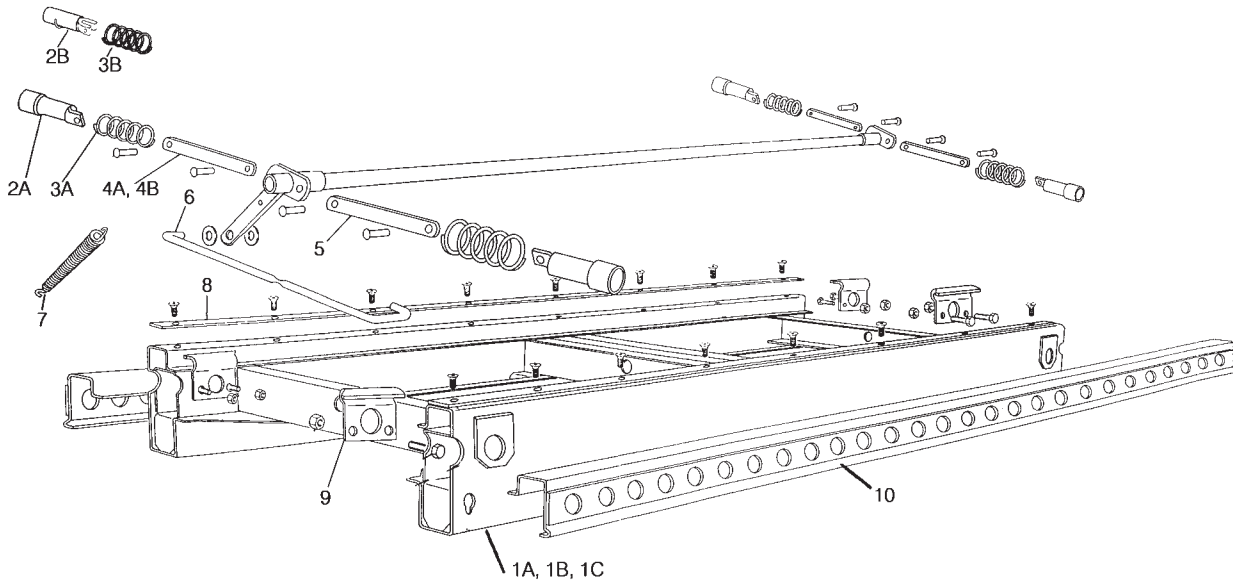

## 8200 Van Sliding Subframe

Item No.	Part No.	Description
1A	HU-8200-42-RLS-SUSP	Subframe Assembly; 42" Frame Width; 38" Spring Centers
		Includes 9700 Hanger Group; 9700 Suspension for 5" Round Axle; 3/4" Spring Seats (Less Springs); 240" Body Rails; Locking Mechanism
1B	HU-8200-42-NO-RLS	Subframe Assembly; 42" Frame Width; 38" Spring Centers
		Includes 9700 Hanger Group; Locking Mechanism
1C	HU-8200-48-NO-RLS	Subframe Assembly; 48" Frame Width; 44" Spring Centers
		Includes 9700 Hanger Group; Locking Mechanism
2A	HU-16006-01	Lock Pin (Manufactured after 1989)
2B	HU-11410-00	Lock Pin (Manufactured before 1989)
3A	HU-12779-01	Compression Spring (Manufactured after 1989)
3B	HU-8098-01	Compression Spring (Manufactured before 1989)
4A	11412-08	Link Strap; 42" Frame Width (Manufactured after 1989)
4B	11412-05	Link Strap; 48" Frame Width (Manufactured after 1989)
5	11412-05	Link Strap (Manufactured after 1989)
6	HU-12781-01	Handle - Pin Release (Manufactured after 1989)
7	HU-8018-02	Spring
8	HU-11421-01	Wear Pad 1/4" x 2" x 96"
9	HU-11420-00	Hold Down Clip
10	18150-19	Body Rail 240"



# Hutch Suspensions

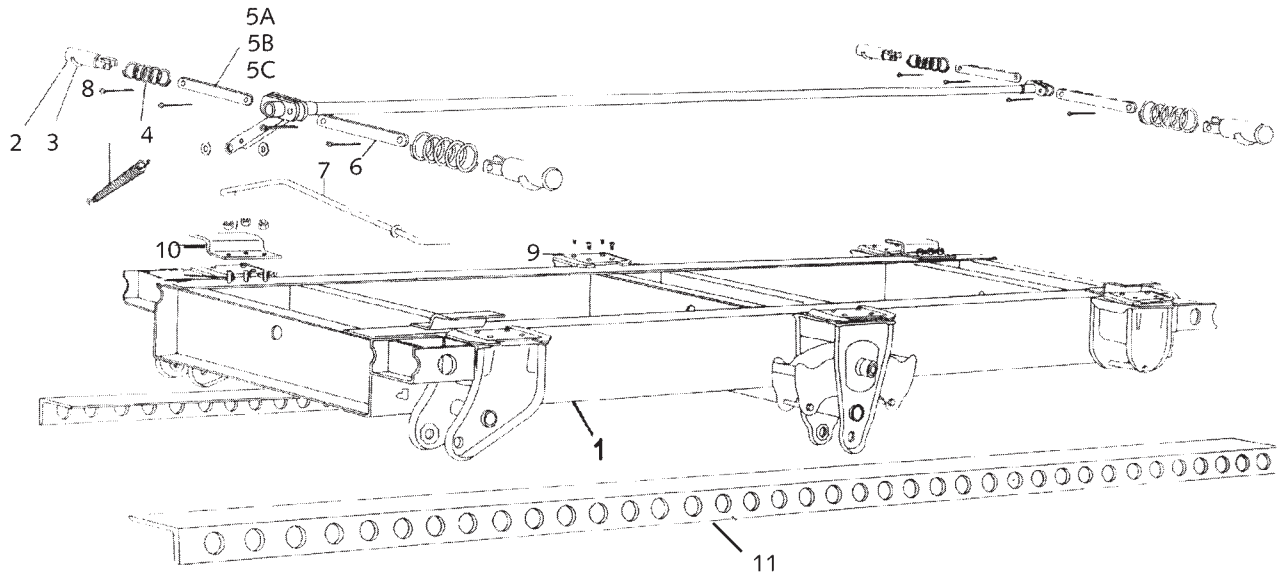

## 8500 Flatbed Sliding Subframe

Item No.	Part No.	Description
1	HU-8500-38-NO-RLS	Subframe Assembly; 38" Spring Centers Includes 9700 Hanger Group; Locking Mechanism
2	11410-02	Lock Pin Assembly 9.19"
3	HU-11414-00	Special Half Washer
4	HU-8098-01	Compression Spring
5A	11412-08	Link Strap; 36" Spring Centers
5B	11412-03	Link Strap; 38" Spring Centers
5C	11412-06	Link Strap; 44" Spring Centers
6	11412-03	Link Strap
7	8518-00	Handle Pin Release
8	HU-8018-01	Spring
9	HU-12818-01	Wear Pad 1/4" x 4" x 5-1/2"
10	8505-00	Hold Down Clip
11	HU-8178-04	Body Rail 240"

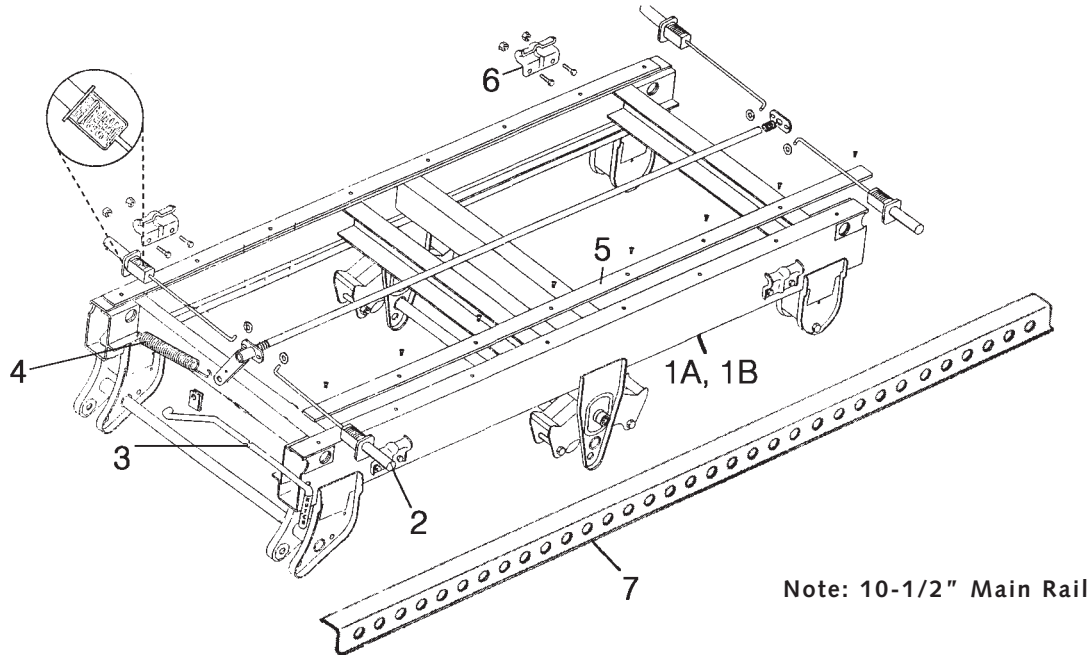

## 9811 Van Sliding Subframe

Item No.	Part No.	Description
1A	HU-9811-48-RLS-SUSP	Subframe Assembly; 48" Frame Width; 44" Spring Centers
		Includes 9700 Hanger Group; 9700 Suspension for 5" Round Axle; 3/4" Spring Seats (Less Springs); 216" Body Rails; Locking Mechanism
1B	HU-9811-48-NO-RLS	Subframe Assembly; 48" Frame Width; 44" Spring Centers
		Includes 9700 Hanger Group; Locking Mechanism
2	HU-19033-03	EZ-Pull Pin Kit Sub-Assembly
3	HU-18797-01	Handle - Pin Release
4	HU-8018-02	Spring
5	HU-11421-01	Wear Pad 1/4" x 2" x 96"
6	HU-20289-01	Hold Down Clip
7	HU-12713-28	Replacement Body Rail 208"

# Hutch Suspensions

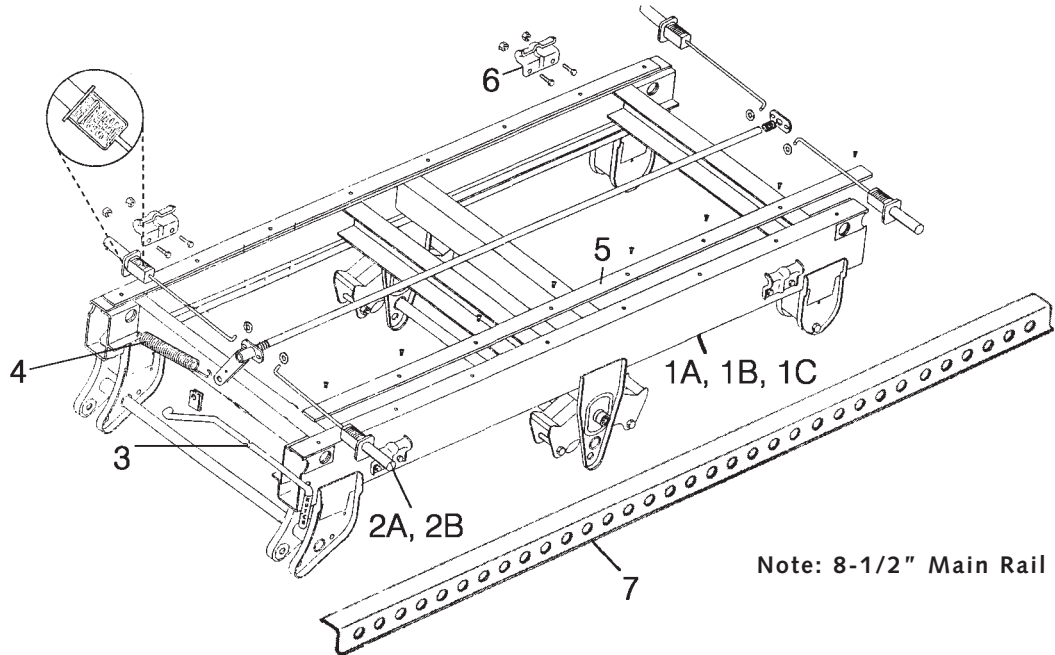

## 9801 Van Sliding Subframe

Item No.	Part No.	Description
1A	HU-9801-48-RLS-SUSP	Subframe Assembly; 48" Frame Width; 44" Spring Centers
		Includes 9700 Hanger Group; 9700 Suspension for 5" Round Axle; 3/4" Spring Seats (Less Springs); 216" Body Rails; Locking Mechanism
1B	HU-9801-48-NO-RLS	Subframe Assembly; 48" Frame Width; 44" Spring Centers
		Includes 9700 Hanger Group; Locking Mechanism
1C	HU-9801-42-NO-RLS	Subframe Assembly; 42" Frame Width; 38" Spring Centers
		Includes 9700 Hanger Group; Locking Mechanism
2A	HU-19033-01	EZ-Pull Pin Kit Sub-Assembly for 42" Frame Width
2B	HU-19033-03	EZ-Pull Pin Kit Sub-Assembly for 48" Frame Width
3	HU-18010-01	Handle - Pin Release
4	HU-8018-02	Spring
5	HU-11421-01	Wear Pad 1/4" x 2" x 96"
6	HU-20289-01	Hold Down Clip
7	HU-12713-28	Replacement Body Rail 208"

## Body Rails

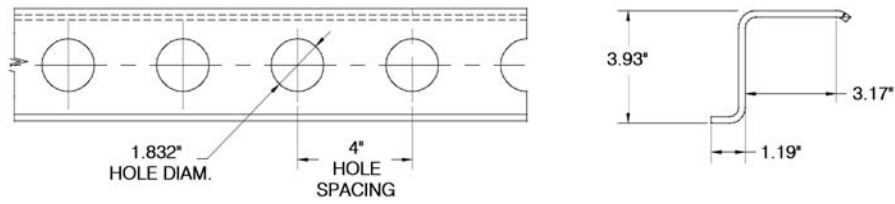

**HU-12713-28**  
208"

**HU-12713-31**  
232"

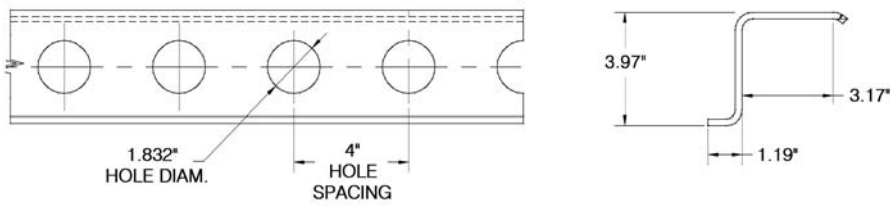

**HU-16816-25**  
240"

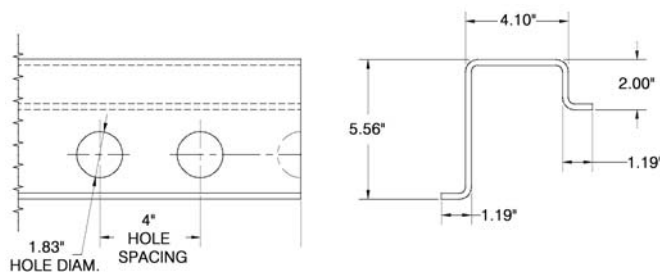

**HU-18150-19**  
240"

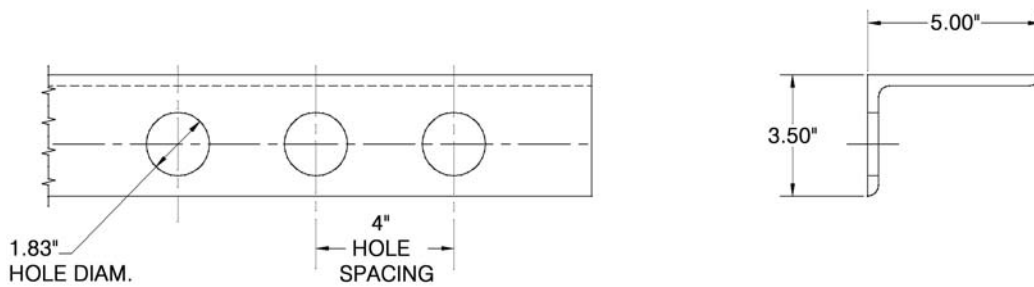

**HU-8178-04**  
240"

# Hutch Suspensions



## MISCELLANEOUS SLIDER COMPONENTS

### Stop Bars

	Part No.	Frame Width	Application
	HU-11641-05	---	8500-38 Slider
	HU-11642-10	48"	8800 & 9800 Sliders
	HU-11485-15	48"	8200 Slider before July 1992
	HU-11642-07	48"	8200 Slider after July 1992
	HU-11642-08	44"	

### Lock Pins

	Part No.	Length	Application
	HU-9611-01	7"	
	HU-8520-00	8-3/4"	
	HU-11410-00	7-5/8"	8200 Van Slider before 1989
	HU-16006-01	7-1/2"	8200 Van Slider after 1989
	HU-12716-01	6-11/16"	8800 Van Slider
	HU-18426-01	7-5/8"	9800 & 9810 Van Sliders

### Hold Down Clips

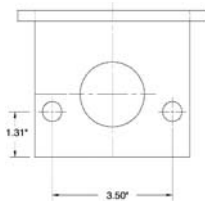

HU-11420-00

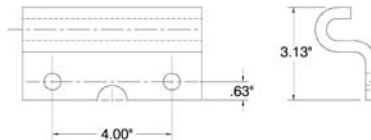

HU-12715-01

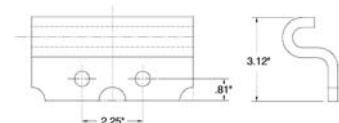

HU-20289-01

### Link Puller Kit



Part No.	Overall Length
HU-8032-07	14-1/2"
HU-8032-08	15-1/2"
HU-8032-09	16-1/2"
HU-8032-10	17-1/2"

### Phenolic Pads



Part No.	Dimensions
HU-8019-01	1/4" x 2" x 11"
HU-12818-01	1/4" x 4" x 15-1/2"
HU-11421-01	1/4" x 2" x 96"

### Spring Handle Retention



Part No.	Length
HU-8018-01	8-5/8"
HU-8018-02	10-1/8"

## MISCELLANEOUS SLIDER COMPONENTS



**Pull Handle**  
HU-12781-01  
8800 Series

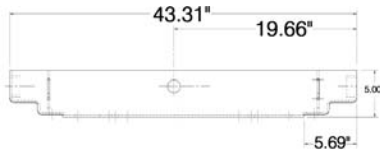

**Slider Pin Cage**  
HU-16238-05  
9000 Series  
44" Spring Centers



**Air Valve  
P-3 Pin Puller**  
HU-17708-01



**Roller Shaft  
Assembly**  
HU-9249-00



**Roller Assembly  
Roller Slider**  
HU-8426-01



**Roll Pin**  
HU-8050-00  
1/4" x 2-1/2"

## Lock Pin Compression Springs



**Flat Washer**  
HU-8035-00  
1-11/16 ID x 2-9/16" OD x 1/8"



HU-8098-01  
2" Diameter x 3-1/2"

HU-12779-01  
1-1/2" Diameter x 3-1/4"

# Hutch Suspensions



## H7700 STRADDLE MOUNT HANGERS



**Front Hanger**  
HU-7701-01



**Center Hanger**  
HU-7702-01



**Rear Hanger**  
HU-7703-01

## H7700 UNDER MOUNT HANGERS



**Front Hanger**  
HU-20728-01



**Center Hanger**  
HU-7702-02



**Rear Hanger**  
HU-20732-01

## H7700 SIDE MOUNT HANGERS



**Front Hangers**  
HU-20729-01 L.H.  
HU-20730-01 R.H.



**Center Hanger**  
HU-7702-03



**Rear Hangers**  
HU-20733-01 L.H.  
HU-20734-01 R.H.

## H7700 FLANGE MOUNT HANGERS (Bolt On)



**Front Hangers**  
HU-7701-07 L.H.  
HU-7701-08 R.H.



**Center Hanger**  
HU-7702-05



**Rear Hangers**  
HU-7703-07 L.H.  
HU-7703-08 R.H.

## H7700 FLANGE MOUNT HANGERS (Weld On)



**Front Hangers**

HU-7701-05 L.H.  
HU-7701-06 R.H.



**Rear Hangers**

HU-7703-05 L.H.  
HU-7703-06 R.H.

## CH7700 STRADDLE MOUNT HANGER



**Front Hanger**

HU-702-01

## H9700 EQUALIZER HANGERS



**Straddle Mount**

HU-16169-01



**Under Mount**

HU-16171-01

## CH7700 UNDER MOUNT HANGERS



**Rear Hanger**

HU-16293-01 L.H.  
HU-16293-02 R.H.

## H7600 STRADDLE MOUNT



**Front Hanger**

HU-7601-01

## H9700 WIDE SPREAD UNDER MOUNT



**Rocker Hanger**

HU-16185-01

## H7700 WIDE SPREAD UNDER MOUNT



**Rear Beam Guide**

HU-7707-14



# Hutch Suspensions

## EQUALIZERS AND HARDWARE



**H7700 Equalizer  
with Bushing**

HU-750-03

Generic 700-3-75



**CH7700 Equalizer  
with Bushing**

HU-19137-01

Generic 700-3-76



**7600 TD Equalizer  
with Bushing**

HU-7750-02



**H9700 Equalizer  
with Bushing**

HU-16158-01

49" Axle Center  
Generic 700-3-102



**CH9700 Equalizer  
with Bushing**

HU-17784-01

49" Axle Center  
Generic 700-3-106



**CH9700 Equalizer  
with Bushing**

HU-16159-03

44" Axle Center



Consists of:  
1 - HU-16169-01  
1 - HU-16158-01  
1 - HU-97ABW

**H9700 Hanger &  
Equalizer Assembly**

HU-16319-01



**Wide Spread  
Equalizer with  
Bushing**

HU-9239-10

109" Axle Center

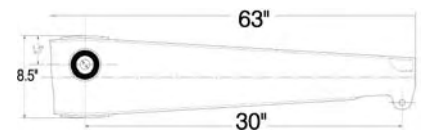

**Wide Spread Rocker**

HU-16168-09

97" Axle Center



**Replacement  
Equalizer Bushing**

HU-7010-00

Rubber



**Replacement  
Equalizer Bushing**

HU-18723-01

Rubber

## EQUALIZER HARDWARE KITS

**HU-77ABW**

	Qty	Part No.	Description
	2	HU-759-00	Bolt
	4	50-2Z-69	Nut
	2	HU-756-00	Spacer Tube
	2	HU-7016-01	Bolt
1	3-36-16	Double Lock Washer	

**HU-97ABW**

	Qty	Part No.	Description
	2	HU-759-00	Bolt
	2	50-2Z-69	Nut
	2	HU-756-00	Spacer Tube
	1	HU-16150-01	Bolt
	2	HU-837-00	Washer
1	HU-11154-00	Nut	

## TORQUE ARMS

**7700/9700  
Adjustable  
Torque Arms  
with Bushings**

	Part No.	A Dimension	Bushing Part No.
	HU-16398-01	14"	3-12-35
	HU-16398-02	16"	
	HU-16398-03	16-5/8"	
	HU-16398-04 Generic 700-3-77	19-1/4"	
	HU-16398-06	21-1/2"	
HU-16398-12	29-1/4"		

**7700/9700  
Non-Adjustable  
Torque Arm  
with Bushings**

	Part No.	A Dimension	Bushing Part No.
	HU-715-00	19-1/4"	3-12-35

**7600  
Adjustable  
Torque Arms  
less Bushings**

	Part No.	A Dimension	Bushing Part No.
	HU-16167-03	16-5/8"	3-12-39
	HU-16167-04	19-1/4"	

**7600  
Non-Adjustable  
Torque Arm  
less Bushings**

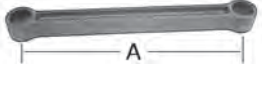
	Part No.	A Dimension	Bushing Part No.
	HU-11953-01	19-1/4"	3-12-39

# Hutch Suspensions



## TORQUE ARM BUSHING KITS



Consists of:  
 1 - 3-13-29 Bolt  
 1 - 3-23-5 Nut  
 1 - 3-12-35 Bushing

700-7-149

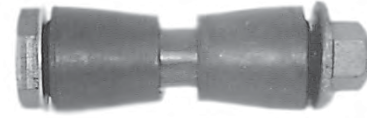

Consists of:  
 1 - HU-12709-01 Bolt  
 1 - HU-34-02 Nut  
 1 - HU-12710-01 Washer  
 1 - HU-12711-01 Washer  
 2 - 3-12-39 Bushing

700-7-230

## 7700/9700 SPRING SEATS

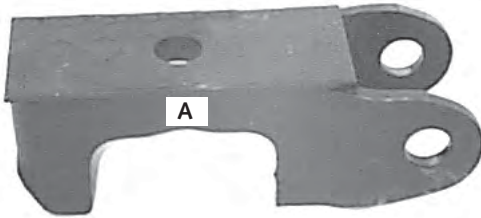

**4" X 6" Axle**

Part No.	Dimension A
HU-19364-01	3/4"
HU-19364-02	1-1/4"

**5" Square Axle**

Part No.	Dimension A
HU-19365-01	3/4"
HU-19365-02	1-1/4"

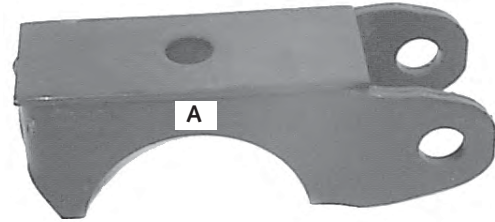

**5" Round Axle**

Part No.	Dimension A
HU-19360-01	3/4"
HU-19360-02	1-1/4"
HU-19360-03	1-3/4"
HU-19360-04	2-1/4"
HU-19360-05	2-3/4"
HU-19360-06	3-1/4"
HU-19360-07	3-3/4"
HU-19360-08	4-1/4"
HU-19360-09	4-3/4"

## 7700/9700 NO-HOP OPTION COMPONENTS



**Torque Arm Attachment**

Part No.	Axle Type
HU-10775-00	5" Round



**Spring Seat**

Part No.	Axle Type	Height
HU-22215-01	5" Round	3/4"

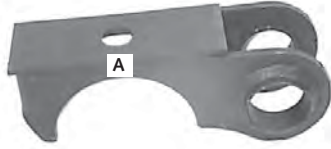

**7600 Axle Seat**  
5" Round

Part No.	"A"
HU-19361-01	3/4"
HU-19361-04	2-1/4"



**7700/9700 Bottom Plate**  
HU-710-00  
5" Round Axle



**CH7700 Bottom Plate**

Part No.	Axle Type
HU-7747-01	5" Square
HU-7746-00	4" x 6" Rect.



**CH7700 Bottom Plate**  
HU-706-01  
Underslung



**Top Plate**  
HU-16868-01



**Hanger Bushing**  
HU-7717-01



**Hanger Wear Plate**  
HU-755-03



**Axle Spacer**  
HU-7028-00  
1-1/2"



**Riser Block**  
HU-7030-00  
1/4" x 3" x 7-9/16"



**Hex Bolt**  
HU-759-00  
5/8" -18 x 4-1/2"



**Hex Bolt**  
HU-719-04  
1-14 x 6"

# Hutch Suspensions



## LEAF SPRINGS

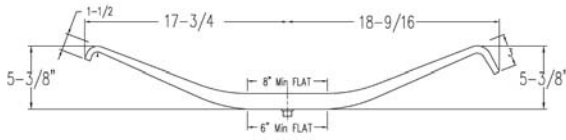

**Low Arch (Single Leaf)**  
**700-3-1**

Replaces TRA026, 7051-42

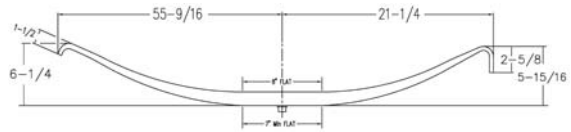

**Low Arch (Single Leaf)**  
**700-3-9**

Replaces TRA021, 7051-01, 363-00

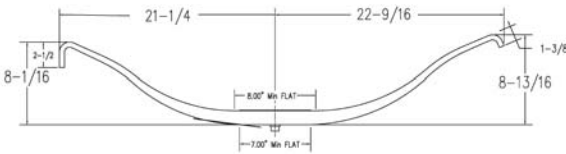

**High Arch (Single Leaf)**  
**700-3-4**

Replaces TRA023, 360-00

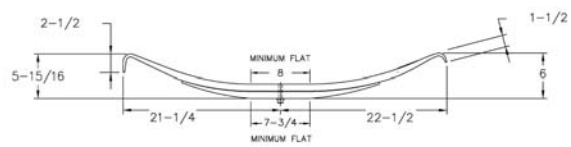

**Low Arch (2 Leaf)**  
**3-A3-83**

Replaces TRA2754, 326-01

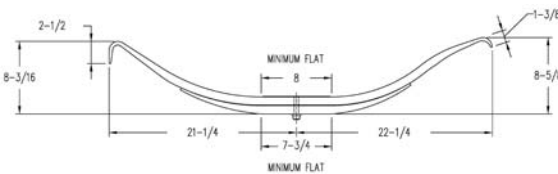

**High Arch (2 Leaf)**  
**3-A3-80**

Replaces TRA2752, 324-01

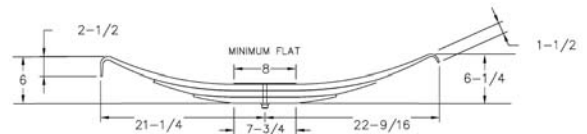

**Low Arch (3 Leaf)**  
**700-3-8**

Replaces TRA2728, 356-00

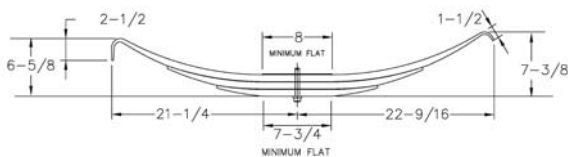

**Medium Arch (3 Leaf)**  
**700-3-7**

Replaces TRA2727, 355-00

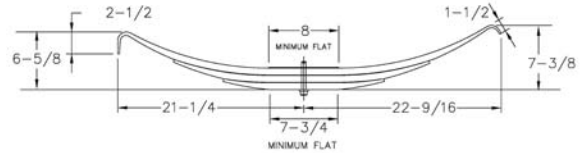

**High Arch (3 Leaf)**  
**700-3-6**

Replaces TRA2726, 354-00

## LEAF SPRINGS

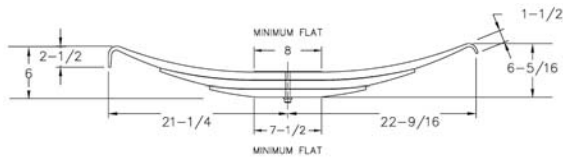

### Low Arch (3 Leaf) H.D.

700-3-11

Replaces TRA2741, 365-01

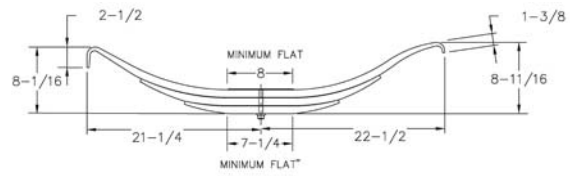

### High Arch (3 Leaf) H.D.

700-3-10

Replaces TRA2740, 365-00

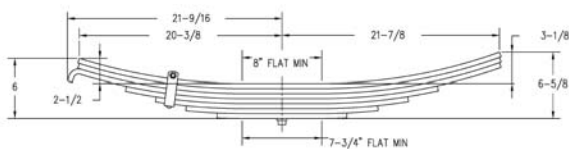

### Low Arch (7 Leaf)

700-3-16

Replaces TRA2706, 751-01

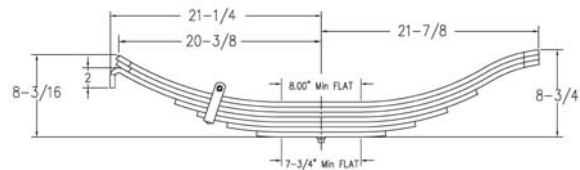

### High Arch (7 Leaf)

700-3-13

Replaces TRA2705, 751-05

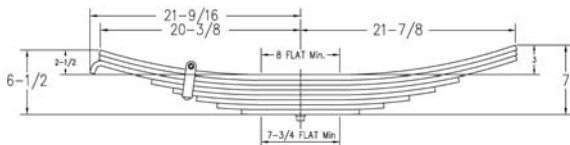

### Low Arch (8 Leaf)

700-3-14

Replaces TRA2732, 752-01

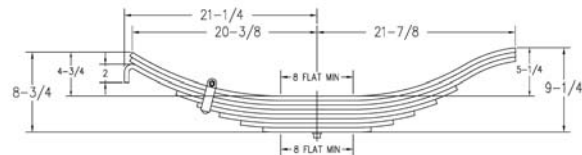

### High Arch (8 Leaf)

700-3-12

Replaces TRA2260, 752-05



### Spring End Pad

HU-814-00

Rubber



### Delrin Spring Liner

HU-7052-02

3" x 7-1/2"

# Trailmobile Suspensions

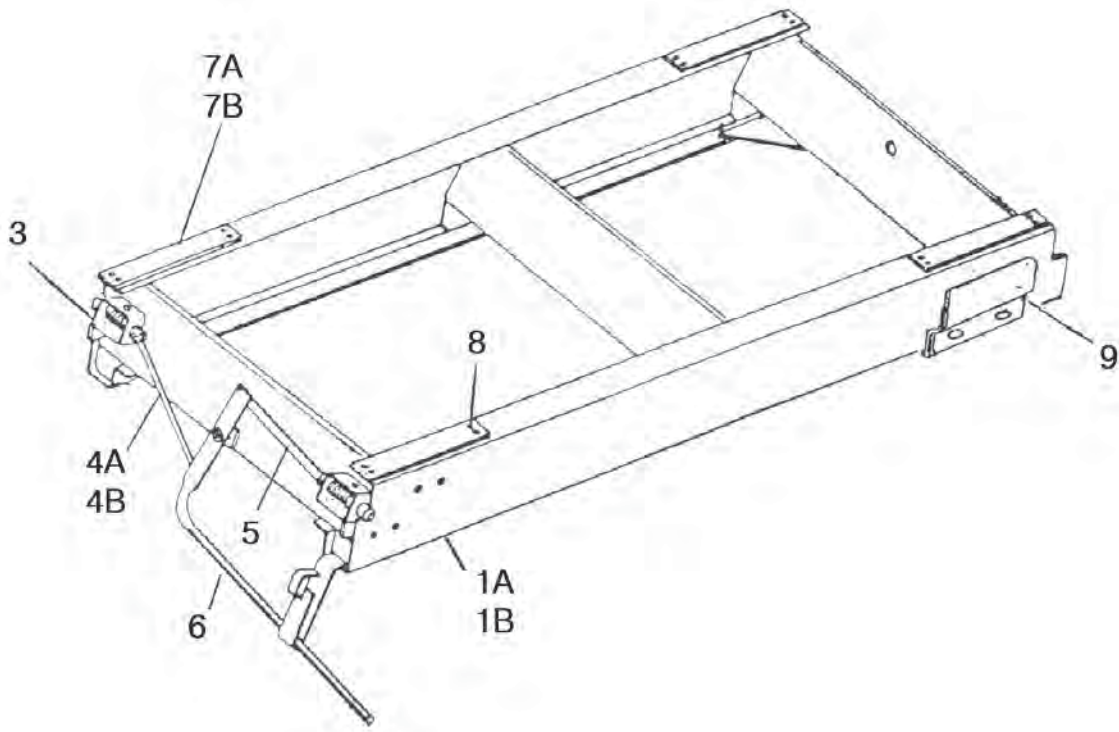

## Old Style "O" Model Subframe

Item No.	Part No.	Description
1A	9001-0-1441	Subframe Assembly; 42" Frame Width
		Includes Hutch 9700 Hanger Group; Locking Mechanism
1B	9001-0-1441-1	Subframe Assembly; 48" Frame Width
		Includes Hutch 9700 Hanger Group; Locking Mechanism
3	1-A33-44	Lock Pin Assembly
4A	700-3-87	Universal Link Strap; 42" Frame Width
4B	700-3-87	Universal Link Strap; 48" Frame Width
5	1-33-98	Link Strap
6	1-A38-5	Handle - Pin Release
7A	3-16-16A	Wear Pad 1/4" x 2-1/2" x 16"
7B	3-16-33B	Wear Pad 1/4" x 2-1/2" x 92-1/4"
8	50-19X-186P-10	Wear Pad Screw 5/16" -18 x 1-1/4"
9	1-A34-6	Hold Down Clip
10	1-1-1033	Body Rail 204-3/4"

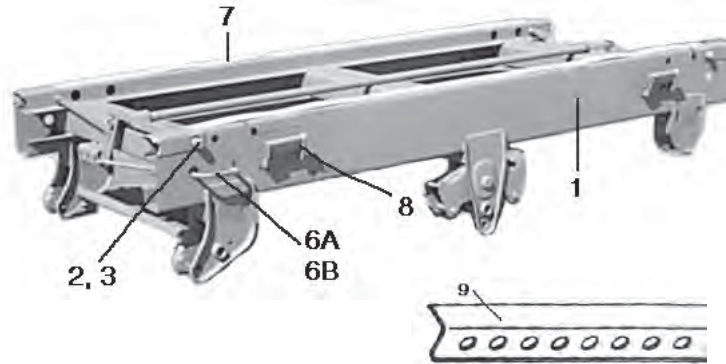

## New Style "O" Model Subframe

Item No.	Part No.	Description
1	1-0-5168-4-1	Subframe Assembly; 48" Frame Width
		Includes Hutch 9700 Hanger Group; Locking Mechanism
2	1-33-121	Lock Pin
3	1-35-16	Compression Spring
6A	1-A38-8	Handle - Pin Release; 42" Frame Width
6B	1-A38-8-1	Handle - Pin Release; 48" Frame Width
7	3-16-38	Wear Pad 1/4" x 2 x 95-3/4"
8	1-34-26	Hold Down Clip
9	700-1-1045	Body Rail 205-3/8"

Note: Lock Pin Kit No. 700-3-70



# Trailmobile Suspensions

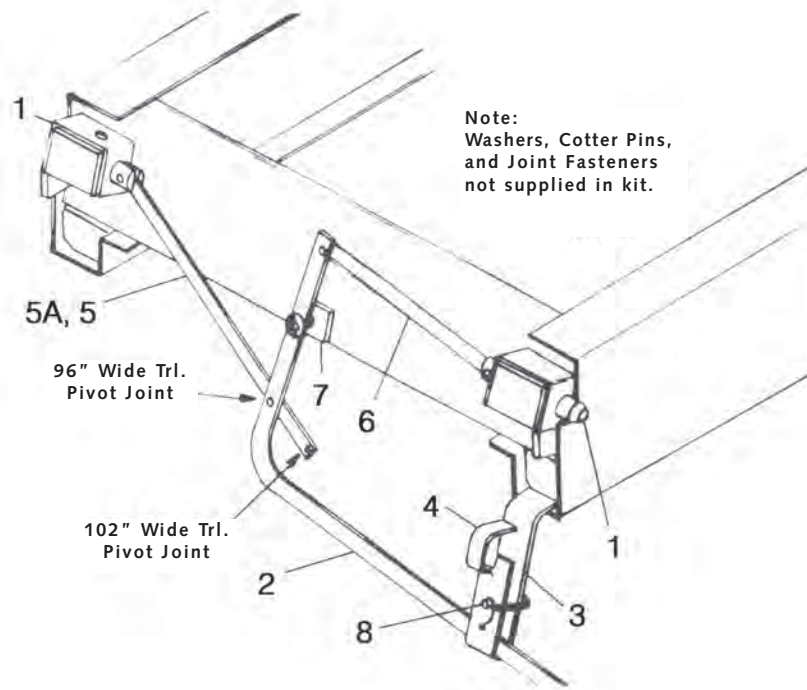

## 'O' Model Subframe Locking Mechanism Assembly (Old Style)

1-A33-45

Components of 1-A33-45:

Item No.	Part No.	Description	Quantity
1	1-A33-44	Locking Pin Assembly	2
2	1-A38-5	Locking Handle Assembly	1
3	1-38-25	Mounting Plate	1
4	1-38-26	Handle Guide	1
5	700-3-87	Universal Link Strap; 42" Frame Width	1
5A	700-3-87	Universal Link Strap; 48" Frame Width	1
6	1-33-98	Link Strap	1
7	1-A34-9	Pivot Assembly	1
8	1-A33-32	Security Pin	1

## Slider Wear Pads

	Part No.	Dimensions	Vans	Flat Beds
	3-16-16A	1/4" x 2-1/2" x 16"	X	
	3-16-16B	1/4" x 2-1/2" x 12-1/2"	X	P31T & P41T
	3-16-26-2	1/2" x 2-1/2" x 12-1/2"	X	F71T
	3-16-33A	1/4" x 2-1/2" x 88"	X	
	3-16-33B	1/4" x 2-1/2" x 92-1/4"	X	
	3-16-38	1/4" x 2" x 95-3/4"	X	

## Hold Down Clamps



1-A34-6



1-34-26



**Lock Pin Assembly  
Old Style**

1-A33-44

Consists of: 1-33-95 Collar;  
1-33-96 Locking Pin; 1-35-12  
Spring; 50-51A-181 Roll Pin



**"A" & "D" Model  
Stop Bar Assembly**

1-A33-29

1-1/2" Dia x 45-3/8"



**Flat Bed (P31T)  
Stop Bar Assembly**

1-A33-30

1-1/2" Dia x 43-3/4"



**Lock Pin Kit  
New Style**

700-3-70

Consists of: 1-33-122 Collar;  
1-33-121 Locking Pin; 1-35-16  
Spring; 50-18T-58 Rivet

## 3-1/2" FABRICATED STRADDLE MOUNT



**Front Hanger**

3-A1-16



**Rear Hanger**

3-A1-17



**Fabricated  
Equalizer with  
Bushing**

3-A66-43

## Equalizer Hardware Kit



700-7-155

Components of 700-7-155:

	Qty	Part No.	Description
	2	50-BIT-34	Bolt
	4	50-2Z-69	Nut
	2	50-BIT-43C	Bolt
	1	3-36-16	Double Lock Washer
	2	3-34-46	Spacer Tube

# Trailmobile Suspensions

## Adjustable Torque Arms with Bushings

	Part No.	Dimension A	Bushing Part No.	Note
	3-A11-65A	17"	3-12-35	Used on 3-1/2" Fabricated Suspension
	3-A11-74G	19-3/8"	3-12-6	Used on 3-1/2" Cast Suspension

## Adjustable Torque Arms less Bushings

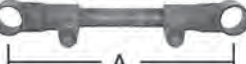
	Part No.	Dimension A	Bushing Part No.	Note
	HU-16167-03	16-5/8"	3-12-39	Used on International Suspension
	HU-16167-04	19-1/4"		

## Non-Adjustable Torque Arms with Bushings

	Part No.	Dimension A	Bushing Part No.	Note
	3-A11-64	17"	3-12-35	Used on 3-1/2" Fabricated Suspension

## Non-Adjustable Torque Arms less Bushings

	Part No.	Dimension A	Bushing Part No.	Note
	HU-11953-01	19-1/4"	3-12-39	Used on International Suspension

Note: On 3-1/2" International and Cast Suspensions, use Adjustable Torque Arms when replacing Non Adjustable side

## Torque Arm Bushing Kits



Consists of:  
 1 - 3-13-29 Bolt  
 1 - 3-23-5 Nut  
 1 - 3-12-35 Bushing

**700-7-149**

3-1/2" Fabricated Suspension



Consists of:  
 1 - HU-12709-01 Bolt  
 1 - HU-34-02 Nut  
 1 - HU-12710-01 Washer  
 1 - HU-12711-01 Washer  
 2 - 3-12-39 Bushing

**700-7-230**

International Suspension



Consists of:  
 1 - 50-18-200 Bolt  
 1 - 3-23-2 Nut  
 2 - 3-36-5 Washer  
 1 - 3-12-7 Sleeve  
 1 - 3-12-6 Bushing

## Torque Arm Bushing Kit

700-7-44  
Cast Suspension



## Torque Arm Bushing

3-12-16  
Rubber & Steel  
2-29/64" O.D.  
x 1-5/16" I.D. x 3"



## Torque Arm Sleeve

3-12-17  
1-5/16" O.D.  
x 4-15/16"

### 3-1/2" FABRICATED SUSPENSION



## Spring Seat 4 X 6 Axle

3-A5-7A      A = 1"  
3-A5-7B      A = 1-3/4"



## Bottom Plate 4 X 6 Axle

3-A5-8

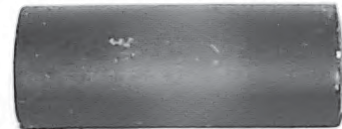

## Top Plate 3-A26-11

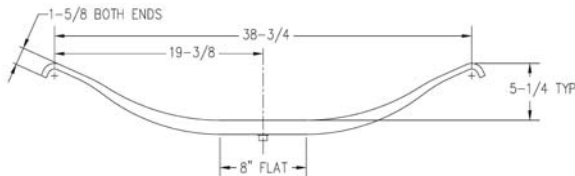

## 3-1/2" (Single Leaf)

3-A3-56  
Replaces TRA051

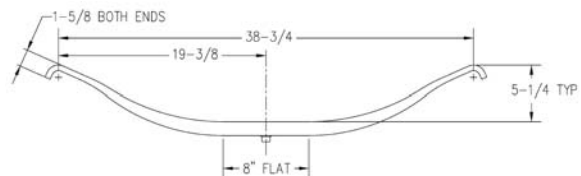

## 3-1/2" (3 Leaf)

3-A3-62  
Replaces TRA1492

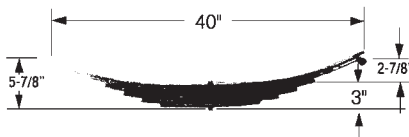

## 3-1/2" (6 Leaf)

3-A3-47  
Replaces TRA1477



## Delrin Spring Liner

3-34-33  
3-1/2" x 7-7/8"

# Fruehauf Suspensions



## UNDER MOUNT HANGERS



**Front Hanger**  
700-3-42  
Replaces UCF2467-001



**Center Hanger**  
700-3-43  
Replaces UXA0034-001



**Rear Hanger**  
700-3-44  
Replaces UCF2470-001



**Front Hanger  
Wide Base**  
700-3-45  
Replaces UCF1466-001



**Center Hanger  
Wide Base**  
700-3-46  
Replaces UCE7746-001



**Rear Hanger used  
with Wide Base**  
700-3-44  
Replaces UCF2470-001



**Rear Hanger**  
700-3-49  
Replaces UCF5858-001

## Cast Equalizers



700-3-36  
Replaces UXA00017



700-3-72  
Replaces UCF6963-001



**Equalizer Bushing  
Kit**  
700-7-85



**Adjustable  
Torque Arm  
(less Bushing)**  
700-3-40  
15-1/2"  
Replaces UCF002640-001



**Non-Adjustable  
Torque Arm  
(less Bushing)**  
700-3-41  
15-1/2"  
Replaces UXA000026-001



**Torque Arm Bushing Kit**  
700-7-83



**Slider Pin Kit**  
700-3-48  
Replaces  
FCF006457-900



**High Arch (Single Leaf)**  
700-3-3  
Replaces TRA011, UXA000186



**Medium Arch (Single Leaf)**  
700-3-19  
Replaces TRA015, UXA000178

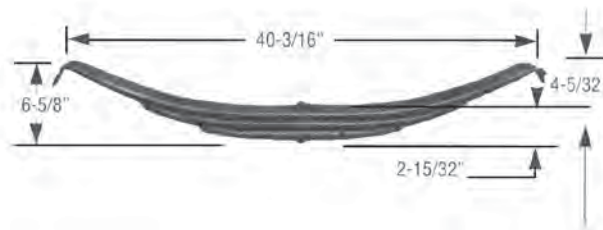

**High Arch (3 Leaf)**  
700-3-32  
Replaces TRA693, UCD0511-1

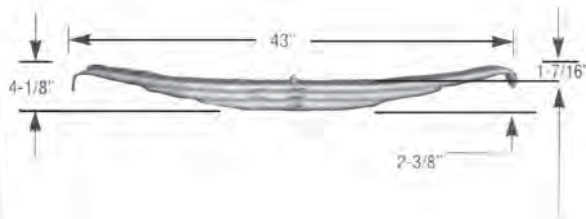

**Low Arch (3 Leaf)**  
700-3-35  
Replaces TRA697, UAC007981-001

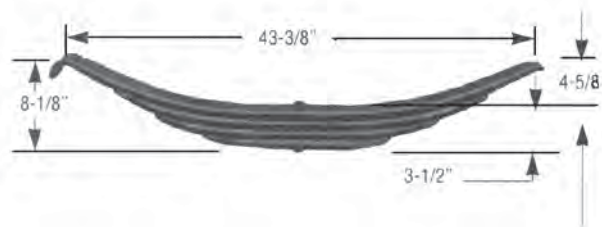

**High Arch (4 Leaf)**  
700-3-33  
Replaces TRA699, UXB000201

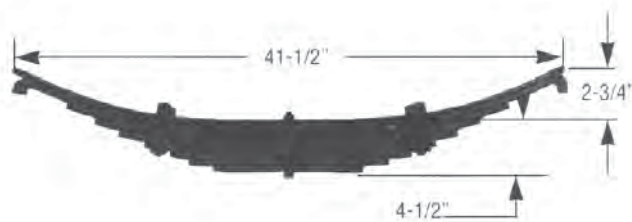

**Low Arch (9 Leaf)**  
700-3-73  
Replaces TRA696, UXA000252

**Axle Conversion Kit**  
**5" Square to 5" Round**  
700-3-114

Each kit contains:

- 2 - 700-3-113 (UXA000028)
- 2 - RY-10114-01 (UXA000047)
- 2 - 700-7-83 (UXA000011900)

# Reyco Suspensions



## 21B UNDER MOUNT HANGERS



**Front Hanger**

RY-T5562 R.H.

RY-T5563 L.H.



**Center Hanger**

RY-T5564



**Rear Hanger**

RY-T5566 R.H.

RY-T5565 L.H.

## 21B FLANGE MOUNT HANGERS



**Front Hanger**

RY-T5424 R.H.

RY-T5425 L.H.



**Center Hanger**

RY-T5426



**Rear Hanger**

RY-T5428 R.H.

RY-T5429 L.H.

## 21B Equalizers (less Bushings)



RY-21725-01

Generic 700-3-60  
42", 49", 53" Axle Spacing



RY-11799-01

44" Axle Spacing



Consists of:

- 4 - RY-T5524 Bushings
- 2 - RY-14247-01 Equalizer Shafts
- 4 - RY-14248-01 Cap Screws
- 4 - RY-14249-01 Washers
- 4 - RY-14250-01 Lock Washers

**Equalizer Bushing Kit (Tandem)**

RY-TK12506

## 21B Adjustable Torque Arms (less Bushings)

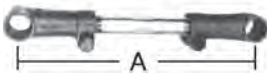
	Part No.	Axle Spacing	Dimension A	Bushing Part No.
	RY-15172-01	42", 44"	16"	RY-T5493
	RY-15173-01	49"	19"	

## 21B Non-Adjustable Torque Arms (less Bushings)

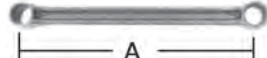
	Part No.	Axle Spacing	Dimension A	Bushing Part No.
	RY-15178-01	44"	16"	RY-T5493
	RY-15179-01	49"	19"	



- Consists of:
- 2 - RY-T2224 Washers
  - 1 - RY-T5495 Lock Nut
  - 1 - RY-T5492 Bolt
  - 2 - RY-T5493 Bushings

### 21B Torque Arm Bushing Kit RY-TK18997

Note: For Tandem Bushing Kit, use RY-TK7319



### 21B Axle Stabilizer RY-08480-01 5" Round

## 21B Axle Seats



### RY-07980-01 3/4" 5 X 5 Axle



### RY-09730-01 3/4" 5" Round Axle



### RY-10114-01 5" Round Axle

## 21B Top & Bottom Plates



### Top Plate RY-08677-01 U Bolts Down



### Top Plate RY-T7175 U Bolts Up



### Bottom Plate RY-09139-01 5" Round Axle



# Reyco Suspensions



## 21B MISCELLANEOUS PARTS

### Spacer Blocks

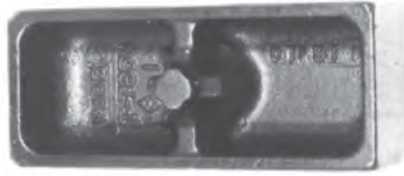

**RY-T7716**  
1"

**RY-T7655**  
2"



**Spring Roller Assembly**  
**RY-TK19011**



**Spring Roller**  
**RY-T2106**



**Spring Roller Bolt**  
**RY-T5544**  
1/2" -20 x 4-3/4"

## MODEL 86 & 88HD STRADDLE MOUNT HANGERS



**Front Hanger**  
**RY-0046-20**



**Center Hanger**  
**RY-0062-20**



**Rear Hanger**  
**RY-0051-20**

## MODEL 86 & 88HD UNDER MOUNT HANGERS



**Front Hanger**  
**RY-0084-00**



**Center Hanger**  
**RY-0088-00**



**Rear Hanger**  
**RY-0086-00**

## MODEL 86 & 88HD FLANGE MOUNT HANGERS



**Front Hanger**  
RY-0400-02 R.H.  
RY-0400-01 L.H.



**Center Hanger**  
RY-0401-00



**Rear Hanger**  
RY-0402-02 R.H.  
RY-0402-01 L.H.

## MODEL 86 & 88 EQUALIZERS & HARDWARE



**Equalizer with Bushing**  
RY-0650-00  
Fabricated



**Equalizer with Bushing**  
RY-0850-00  
Cast



Consists of:  
1 - RY-0001-14 Bolt  
1 - RY-0649-02 Bushing  
1 - RY-0274-01 Lock Nut

**Equalizer Bushing Kit**  
RY-0649-04

## MODEL 86 & 88 TORQUE ARMS & HARDWARE

### Adjustable Torque Arm with Bushings

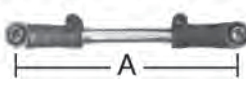
	Part No.	Axle Spacing	Dimension A	Bushing Part No.
	RY-1035-20	49" & 54"	19-7/8"	RY-09729-01

### Non-Adjustable Torque Arm with Bushings

	Part No.	Axle Spacing	Dimension A	Bushing Part No.
	RY-0075-20	49" & 54"	19-7/8"	RY-09729-01



Consists of:  
1 - RY-0001-08 Bolt  
1 - RY-09729-01 Bushing  
1 - RY-14345-01 Lock Nut  
1 - RY-T7292 Washer

**Torque Arm Bushing Kit**  
RY-0022-01

# Reyco Suspensions



## MODEL 86 & 88 AXLE SEATS, BOTTOM PLATES, & MISC.

### Axle Seats



**RY-0636-01**

1"  
5" Round Axle

**RY-0636-02**

2"  
5" Round Axle



**Hanger Wear Pad**

**RY-0045-00**



**Bottom Plate**

**RY-0538-00**

5" Round Axle



**Bottom Plate**

**RY-0415-00**

No Hop  
5" Round Axle



**Spring Roller**

**RY-0741-01**

### Cap Screws



**RY-0001-04**

5/8" -18 x 4-1/2"

**RY-0001-02**

5/8" -18 x 5-1/8"



**Lock Nut**

**RY-0002-07**

5/8" -18

### MODEL 86AR

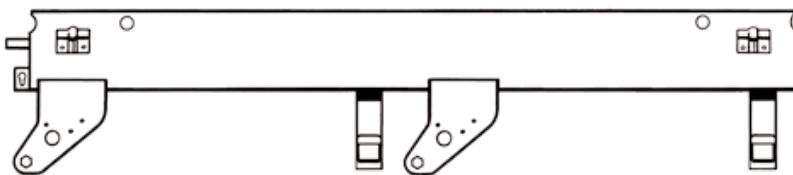

**Model 86AR/RS1015**

**RY-19786-48**

Subframe with hangers; to mate with Binkley slider rails



**Spring Beam  
Assembly**

**RY-19914-01** R.H.

**RY-11913-01** L.H.

**Rigid Track Rod Assy**

**RY-10910-01**

44"

## MODEL 102 TORQUE ARMS & HARDWARE

### Adjustable Torque Arm (less Bushings)

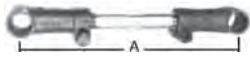
	Part No.	Axle Spacing	Dimension A	Bushing Part No.
	RY-15354-01	52" & 60"	21"	RY-T2242

### Adjustable Torque Arm (Includes RY-09729-01 Axle End Bushing)

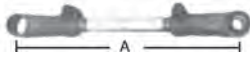
	Part No.	Axle Spacing	Dimension A	Hanger End Bushing Kit Part No.
	RY-15186-01	52" & 60"	20-1/2"	RY-TK21640T



**Torque Arm Bushing**  
RY-09729-01



**Torque Arm Bushing Kit**  
RY-TK21640T



**Lock Nut**  
RY-T5495

## LEAF SPRINGS

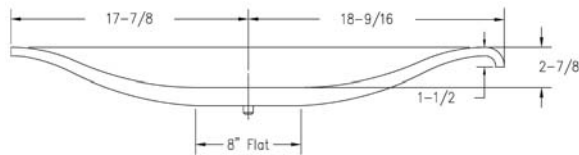

**Medium Arch (Single Leaf)**

700-3-115

Replaces TRA035, T7297

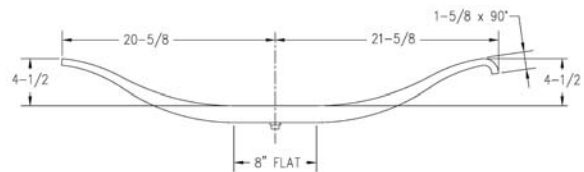

**Medium Arch (Single Leaf)**

RY-15636-01

Replaces TRA038

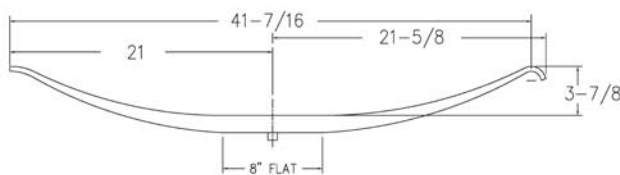

**Medium Arch (Single Leaf)**

700-3-2

Replaces TRA031, T5555

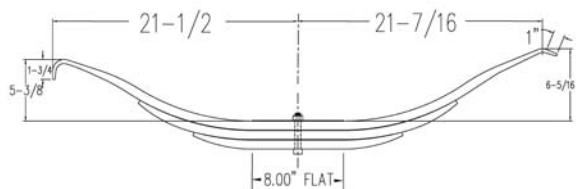

**High Arch (3 Leaf)**

RY-0079-01

Replaces TRA3340

# Reyco Suspensions

## LEAF SPRINGS

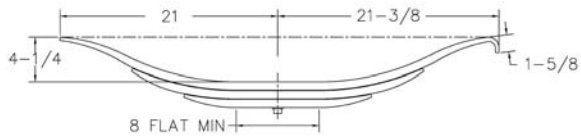

### Medium Arch (3 Leaf)

**RY-08376-01**

Replaces TRA2291

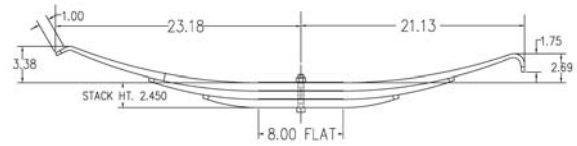

### Low Arch (3 Leaf)

**RY-0079-02**

Replaces TRA3341

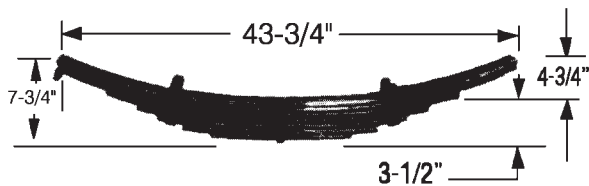

### High Arch (7 Leaf)

**700-3-30**

Replaces TRA2256, T3086

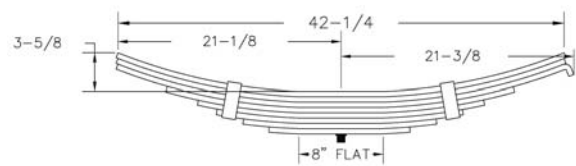

### Medium Arch (8 Leaf)

**700-3-74**

Replaces TRA2270, T3564

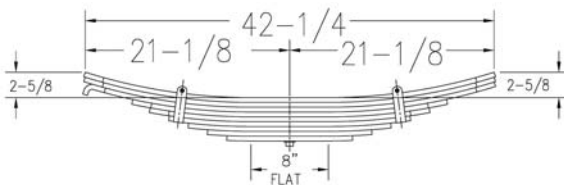

### Medium Arch (9 Leaf)

**700-3-89**

Replaces TRA2297, T7452

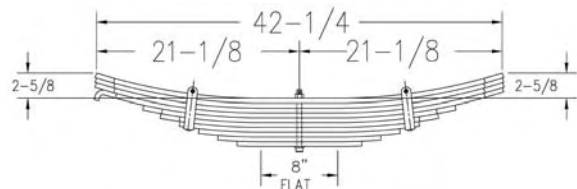

### Medium Arch (10 Leaf)

**700-3-90**

Replaces TRA2297HD-10, T7452-10

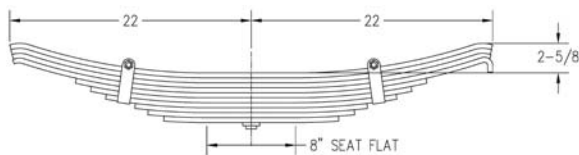

### Low Arch (10 Leaf)

**700-3-107**

Replaces TRA3343, 18356-01

## Subframe with Hangers RW-B7420N1002



**Air Spring**  
RW-A2258F1410



**Shock Absorber**  
RW-85919



**Hold Down Clamp  
Kit**  
RW-KIT11117



**Lower Control Arm  
Adjustable**  
RW-A13133Y8345



**Lower Control Arm  
Non-Adjustable**  
RW-A3133G8249



**Bushing Kit  
Lower Control Arm**  
RW-KIT11102



**Bolt Kit for Upper &  
Lower Control Arm**  
RW-KIT11107



**Bolt Kit  
Upper Control Arm  
Adjustable**  
RW-KIT11106



**Bolt Kit  
Upper Control Arm  
Non-Adjustable**  
RW-KIT11107

# Meritor RHP11 Suspension



**Upper Control Arm  
Bushings & Bolt Kit**  
RW-KIT11300



**Side Plate Repair  
Kit**  
RW-KIT11301

# Dana RS Advantage Suspension



**Air Spring**  
DA-SR1JA100  
With Mounting Hardware

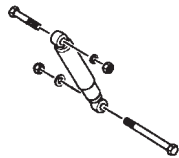

**Shock Absorber**  
DA-SR1JA102  
With Mounting Hardware



**Pivot Bolt Kit**  
DA-SR1JA103  
One Side

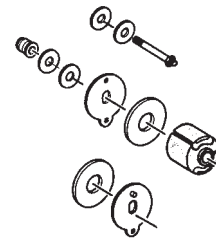

**Pivot Bushing Kit**  
DA-SR1JA112  
One Side

## ROUND TOP U BOLT KITS

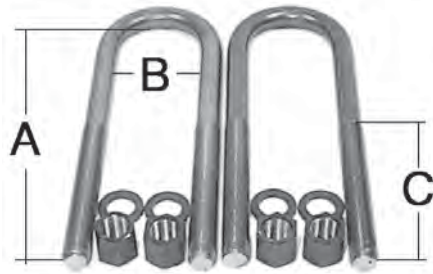

## SQUARE TOP U BOLT KITS

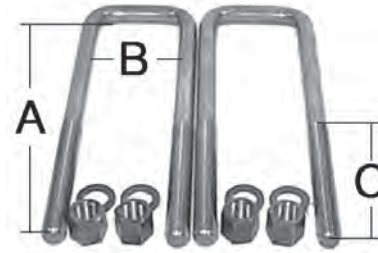

Each kit consists of:

- 2 - U Bolts
- 4 - Hi Nuts
- 4 - Washers

### 7/8" Diameter

Part No.	B	A	C
700-3-111	3"	10"	6"
700-3-23		12"	
700-3-26		14"	
700-3-88		16"	
700-3-50		17"	
700-3-29	3-1/2"	12-1/2"	
700-3-27		16"	
700-3-38	5"	12"	
700-3-25		14"	
700-3-105		15"	
700-3-86	5-3/4"	15-3/4"	

Part No.	B	A	C
700-3-24	3-1/2"	14"	6"
700-3-28	5"	14.73"	

### 3/4" Diameter

Part No.	B	A	C
700-3-80	3"	12-1/2"	6"
700-3-81		15-1/2"	
700-3-82		17-1/2"	

Part No.	B	A	C
700-3-108	3.19"	11.38"	6"
700-3-109		14.88"	



**U Bolt Hi Nut**  
3-23-9  
7/8" -14



# Miscellaneous



## Spring Center Bolt with Nut

3-73-38

1/2" -20 x 6"

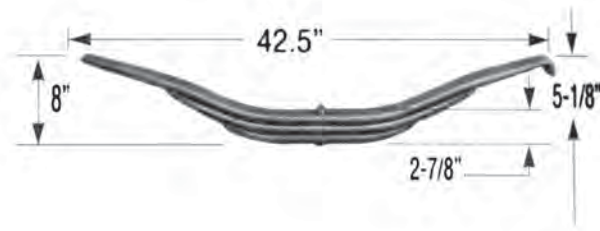

## Dayton High Arch (3 Leaf)

700-3-31

Replaces TRA3113, 39100100



# Landing Gear and Components

---

<b>HOLLAND BINKLEY LANDING GEAR .....</b>	<b>5-1 TO 5-6</b>
<b>BUTLER LANDING GEAR .....</b>	<b>5-7 TO 5-8</b>
<b>HOLLAND LANDING GEAR .....</b>	<b>5-9 TO 5-10</b>
<b>JOST LANDING GEAR .....</b>	<b>5-11 TO 5-14</b>
<b>AUSTIN-WESTRAN LANDING GEAR .....</b>	<b>5-15 TO 5-22</b>
<b>MOUNTING BRACKETS .....</b>	<b>5-23 TO 5-27</b>
<b>BRACING .....</b>	<b>5-27 TO 5-30</b>
<b>SAND SHOES .....</b>	<b>5-31 TO 5-33</b>
<b>CRANK HANDLES .....</b>	<b>5-34</b>
<b>MISCELLANEOUS .....</b>	<b>5-35</b>
<b>LANDING GEAR PART NUMBER CROSS REFERENCE .....</b>	<b>5-36 TO 5-39</b>

# Holland Binkley Landing Gear

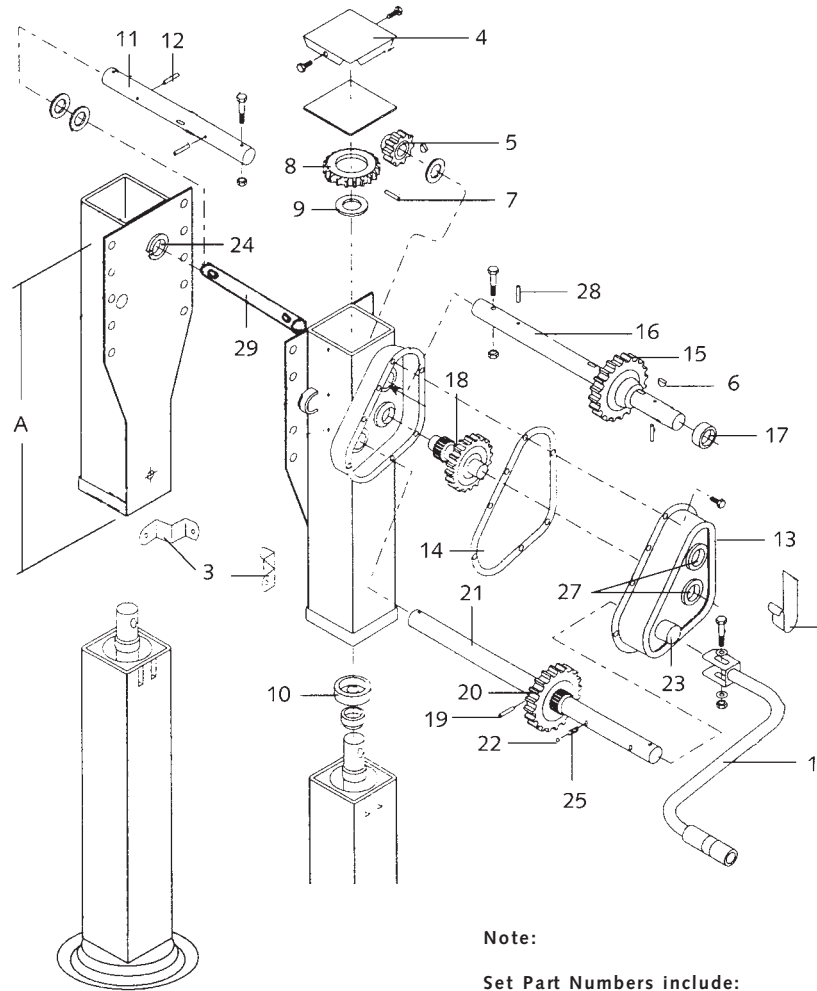

Note:

Set Part Numbers include:

- 1 - Crank Handle
- 1 - Cross Shaft
- 1 - Crank Hanger
- 2 - Brace Lugs

## BINKLEY 50,000 CHALLENGER MODEL Universal Mounting

Set Part No.	Gear Box Leg Part No.	Non Gear Box Leg Part No.	Travel	Dimension A	Footware
BK-4-A5-380S	BK-4-A5-381GB	BK-4-A5-382NGB	19"	30-1/2"	4-1/2" x 10" x 12" Tilt Shoe
BK-700-4-342S	BK-700-4-343GB	BK-700-4-344NGB	17"	28"	10" Diameter Shock Foot
BK-700-4-349S	BK-700-4-350GB	BK-700-4-351NGB	13-1/2"	25-1/2"	4-1/2" x 10" x 10" Sand Shoe
BK-700-4-179S	BK-700-4-180GB	BK-700-4-181NGB	17"	28"	4-1/2" x 10" x 10" Sand Shoe
BK-700-4-416S	BK-700-4-417GB	BK-700-4-418NGB	19"	30-1/2"	10" Diameter Removable Cushion Foot

## BINKLEY 50,000 CHALLENGER MODEL

Item No.	Part No.	Description
1	BK-LG0083-01	Crank Handle
2	BK-LG0085	Crank Hanger
3	BK-LG0266	Brace Lug
4	BK-LG0264	Cover
5	BK-LG0531-02	Pinion Gear
6	BK-PP0018-02	Woodruff Key
7	BK-PP0052-21	Groove Pin 3/8" x 2"
8	BK-LG0570-01	Bevel Gear
9	BK-PP0016-62	Washer
10	BK-PP0013-77	Thrust Bearing
11	BK-LG0259	Jack Shaft L.H. Universal Mount
12	BK-PP0014-27	Roll Pin 1/4" x 1-1/2"
13	BK-LG0663	Gear Box Cover
14	BK-LG0428	Gasket
15	BK-LG0543-01	Output Gear
16	BK-LG0260	Jack Shaft R.H. Universal Mount
17	BK-LG0219-01	Spacer Bushing
18	BK-LG0542-01	Idler Gear
19	BK-PP0014-07	Groove Pin 1/4" x 1-1/2"
20	BK-LG0541-01	Input Gear
21	BK-LG0261-01	Shift Shaft Universal Mount
	BK-LG0371-01	Shift Shaft I-Beam Mount
22	BK-XB-BAL-023-07	Shift Lock Ball
23	BK-LG0658-01	Bushing
24	BK-XB-LG0219-02	Bushing
25	BK-XB-SPG-020-36	Shift Lock Spring
27	BK-LG0659-01	Bushing
28	BK-PP0014-27	Roll Pin 1/4" x 1-1/2"
29	BK-LG0094-6650	Cross Shaft 66-1/2"

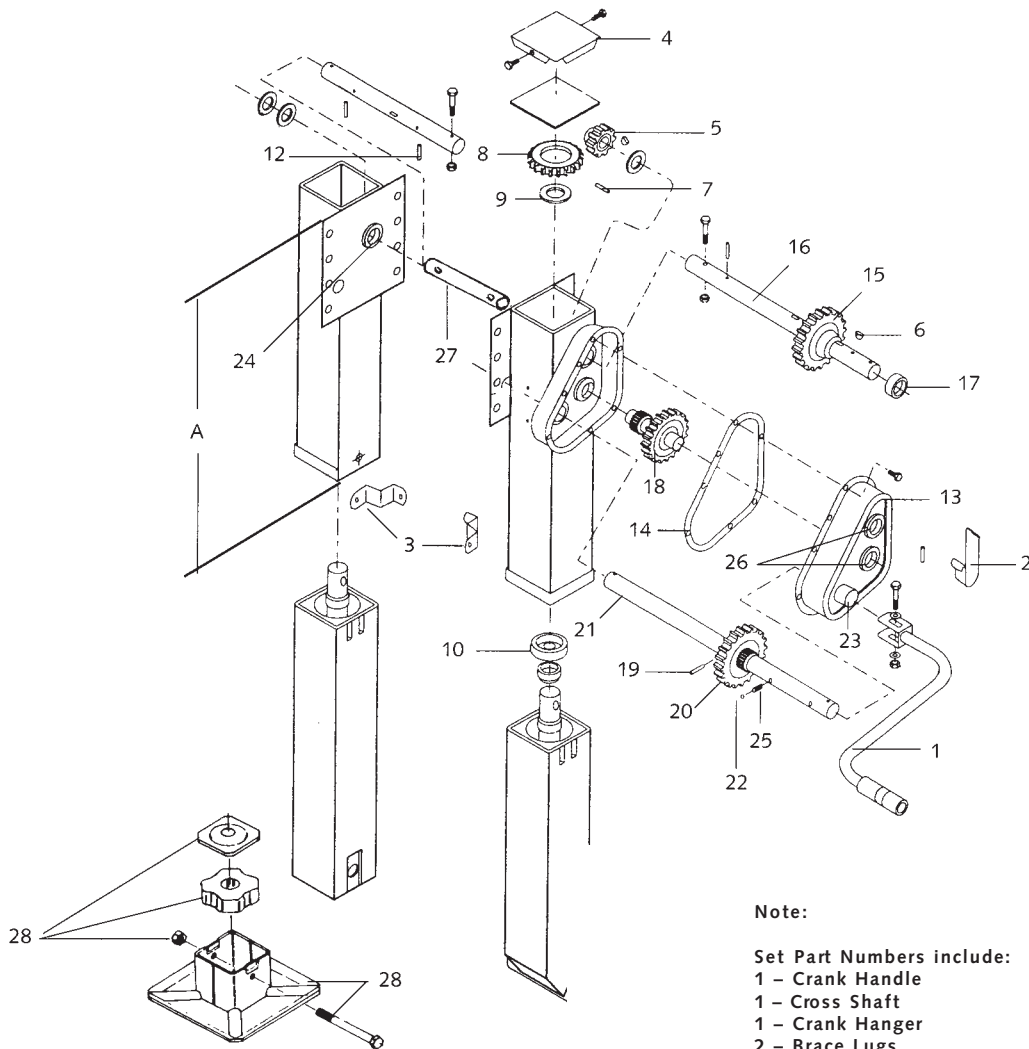

## BINKLEY 51,000 CONTENDER MODEL Universal Mounting

Set Part No.	Gear Box Leg Part No.	Non Gear Box Leg Part No.	Travel	Dimension A	Footware
BK-700-4-272S	BK-700-4-273GB	BK-700-4-274NGB	17"	28"	4-1/2" x 10" x 12" Tilt Shoe
BK-700-4-345S	BK-700-4-346GB	BK-700-4-347NGB	17"	30"	10" x 10" Removable Cushion Foot
BK-700-4-369S	BK-700-4-370GB	BK-700-4-371NGB	17"	28"	10" x 10" Removable Cushion Foot Minimum Retract Length
BK-700-4-425S	BK-700-4-426GB	BK-700-4-427NGB	19"	30"	2" x 10" x 10" Sand Shoe
BK-700-4-485S	BK-700-4-486GB	BK-700-4-487NGB	17"	28"	2" x 10" x 10" Sand Shoe

## BINKLEY 51,000 CONTENDER MODEL

Item No.	Part No.	Description
1	BK-LG0083-01	Crank Handle
2	BK-LG0085	Crank Hanger
3	BK-LG0266	Brace Lug
4	BK-LG0880	Cover
5	BK-LG1823-01	Pinion Gear
6	BK-PP0018-02	Woodruff Key
7	BK-PP0052-21	Groove Pin 3/8" x 2"
8	BK-LG0570-01	Bevel Gear
9	BK-PP0016-62	Washer
10	BK-PP0013-77	Thrust Bearing
12	BK-PP0014-27	Roll Pin 1/4" x 1-1/2"
13	BK-LG0663	Gear Box Cover
14	BK-LG0428	Gasket
15	BK-LG0543-01	Output Gear
16	BK-LG0928	Jack Shaft R.H. Universal Mount
17	BK-LG0219-01	Spacer Bushing
18	BK-LG0542-01	Idler Gear
19	BK-PP0014-07	Groove Pin 1/4" x 1-1/2"
20	BK-LG0541-01	Input Gear
21	BK-LG0261-01	Shift Shaft Universal Mount
22	BK-XB-BAL-023-07	Shift Lock Ball
23	BK-LG0658-01	Bushing
24	BK-XB-LG0219-02	Bushing
25	BK-XB-SPG-020-36	Shift Lock Spring
26	BK-LG0659-01	Bushing
27	BK-LG0094-6650	Cross Shaft 66-1/2"
28	BK-LG0048-01	Removable Cushion Foot Assembly

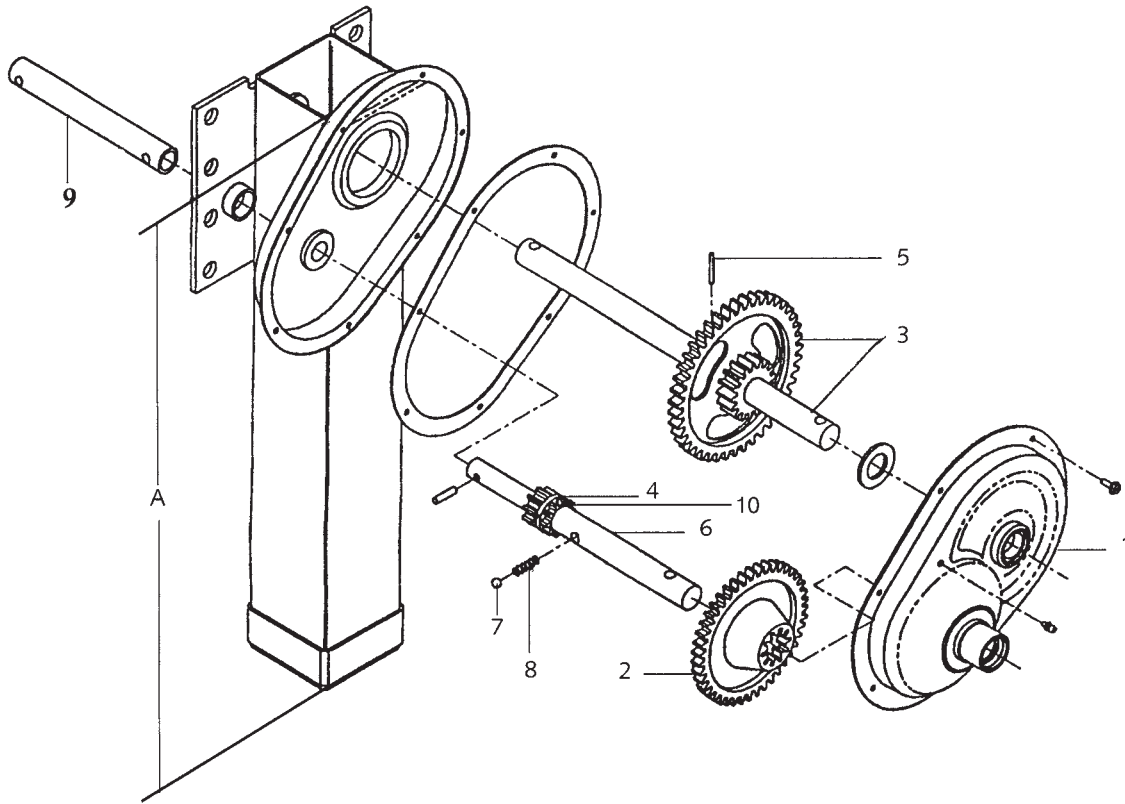

**Note:**

Set Part Numbers include:

- 1 - Crank Handle
- 1 - Cross Shaft
- 1 - Crank Hanger
- 2 - Brace Lugs

## BINKLEY FG4000 FAST GEAR MODEL Universal Mounting

Set Part No.	Gear Box Leg Part No.	Non Gear Box Leg Part No.	Travel	Dimension A	Footware
BK-700-4-413S	BK-700-4-414GB	BK-700-4-415NGB	17"	30"	10" x 10" Removable Cushion Foot
BK-700-4-478S	BK-700-4-479GB	BK-700-4-480NGB	17"	28"	10" x 10" Removable Cushion Foot Minimum Retract Length
BK-700-4-495S	BK-700-4-496GB	BK-700-4-497NGB	17"	30"	2" x 10" x 10" Sand Shoe

## BINKLEY FG4000 FAST GEAR MODEL

Item No.	Part No.	Description
1	BK-LG0944-10	Gear Box Cover
2	BK-LG0934	Input Gear
3	BK-LG2242-01	Output Gear Kit
4	BK-LG0933-01	Input Gear - Low
5	BK-PP0052-21	Groove Pin 3/8" x 2"
6	BK-LG0910	Shift Shaft
7	BK-XB-BAL-023-07	Shift Lock Ball
8	BK-XB-SPG-020-36	Shift Lock Spring
9	BK-LG0932	Extension Shaft
10	BK-GP-052-11	Drive Pin .250" x 1"

**Note:**

For more parts information on the FG4000 Landing Gear, please refer to the 51,000 Contender parts breakdown on pages 5-3 and 5-4



# Butler Landing Gear

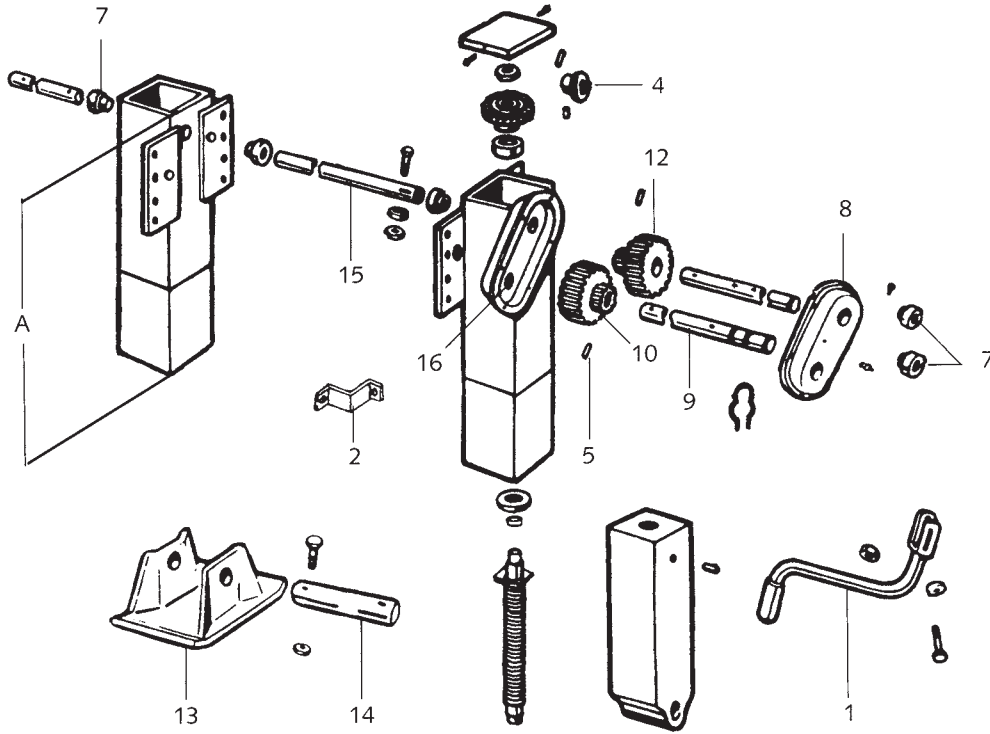

Note:

- Set Part Numbers include:  
 1 - Crank Handle  
 1 - Cross Shaft  
 2 - Brace Lugs

## BUTLER 26110 VOYAGER MODEL Universal Mounting

Set Part No.	Gear Box Leg Part No.	Non Gear Box Leg Part No.	Travel	Dimension A	Footware
BP-700-4-364S	BP-700-4-365GB	BP-700-4-366NGB	16-1/2"	26-3/4"	4-1/2" x 10" x 12" Sand Shoe

## BUTLER 26110 VOYAGER MODEL

Item No.	Part No.	Description
1	BP-20-99029	Crank Handle
2	BP-20-20503	Brace Lug
4	BP-10-50058	Pinion Gear
5	BP-10-80126	Groove Pin 1/4" x 1-1/4"
7	BP-10-70020	Bushing
8	BP-20-40500	Gear Box Cover
9	BP-20-60500	Crank Shaft Universal Mounting
10	BP-10-50046	Crank Shaft Gear
12	BP-10-50053	Cross Shaft Gear
13	BP-20-110101	Sand Shoe
14	BP-20-10501	Sand Shoe Axle
15	BP-20-60001	Cross Shaft 59-3/4"
16	BP-10-70501	Flange Bearing

# Holland Landing Gear

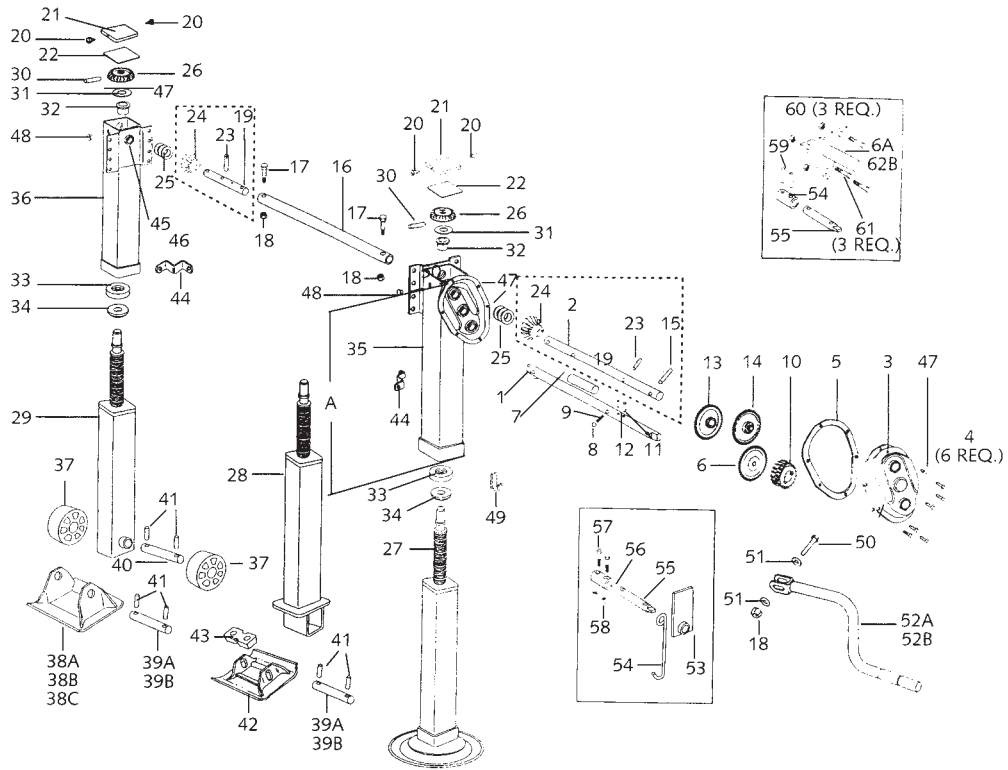

**Note:**

- Set Part Numbers include:  
 1 - Crank Handle  
 1 - Cross Shaft  
 1 - Crank Hanger  
 2 - Brace Lugs

**HOLLAND MARK V MODEL  
 Universal Mounting  
 Manufactured after May 1994**

Set Part No.	Gear Box Leg Part No.	Non Gear Box Leg Part No.	Travel	Dimension A	Footware
HL-700-4-378S	HL-700-4-379GB	HL-700-4-380NGB	16-1/2"	28"	12" Diameter Self-Leveler
HL-700-4-381S	HL-700-4-382GB	HL-700-4-383NGB	16-1/2"	28"	4-1/2" x 12" x 11-1/2" Sand Shoe
HL-700-4-384S	HL-700-4-385GB	HL-700-4-386NGB	17-1/2"	29-1/4"	12" Diameter Self-Leveler
HL-700-4-387S	HL-700-4-388GB	HL-700-4-389NGB	17-1/2"	29-1/4"	4-1/2" x 12" x 11-1/2" Sand Shoe

## HOLLAND MARK V MODEL

No.	Part No.	2-Speed Side	Single-Speed Side	Description
1	XA-V-06625-A	1		Crank Shaft
2	XA-V-06624-A	1		Drive Gear Shaft
3	XA-V-06618	1		Gearbox Cover
4	XB-06372	8		Thread Rolling Screw
5	XB-V-06621	1		Gearbox Gasket
6	XA-V-06602	1		Idler Gear
7	XA-V-07085	1		Idler Gear Shaft
8	XB-BAL-023-01	1		Ball
9	XB-SPG-020-02	1		Spring
10	XA-V-06604-1	1		Shifter Gear
11	XA-CRP-V-06633	1		Pin, .25" x 1.44"
12	XB-21-S-218-1500	1		Spring Pin, .22" x 1.25"
13	XA-V-06606	1		Spur Gear
14	XA-V-06603	1		Step Gear
15	XA-CRP-V-06634	1		Pin, .38" x 1.5"
16	XA-V-1910		1	Cross Shaft (specify frame width, mounting style, model no.)
17	XB-V-444-1	1	1	HHCS, 3/8" -16 x 1.75"
18	XB-338	2	1	Locknut, 3/8" -16
19	XA-V-06623-A		1	Bevel Gear Shaft (Single-Speed)
20	XB-06372	2	2	Thread Rolling Screw
21	XA-V-06611	1	1	Upper Leg Cover
22	XB-V-07054	1	1	Gasket
23	XB-GP-38-1-12-E	1	1	Groove Pin
24	XA-V-06600	1	1	Bevel Pinion Gear
25	XB-01977	2	2	Shim (as required)
26	XA-V-06601	1	1	Bevel Gear
27	XA-V-06628-010-1 through -515-1	1	1	Inner Leg & Screw Assembly (01 Series)
28	XA-V-06628-020-2 through -514-2	1	1	Inner Leg & Screw Assembly (14 Series)
29	XA-V-06628-000-0 through -505-0	1	1	Inner Leg & Screw Assembly (05, 13, or 15 Series)
30	XA-CRP-V-06635	1	1	Pin, .38" x 2"
31	XB-V-06632	1	1	Washer
32	XB-V-06630	1	1	Bushing
33	XB-V-647	1	1	Thrust Bearing
34	XA-V-06629	1	1	Collar
35	XA-V-07133-0 through -5	1		2-Speed Upper Leg
36	XA-V-07132-0 through -5		1	Single-Speed Upper Leg
37	XB-V-747	2	2	Wheel

No.	Part No.	2-Speed Side	Single-Speed Side	Description
38A	XA-V-796-B-1	1	1	Skid Foot (05 Series) 4.9" x 12" x 11.5"
38B	XA-V-796-L	1	1	Low Profile Skid Foot (13 Series) 2.5" x 12" x 11.5"
38C	XA-V-796-WS	1	1	Weight Saver Skid Foot (15 Series) 3" x 10" x 11.5"
39A	XA-V-1901-1	1	1	Standard Axle
39B	XA-V-1903-1	1	1	Solid Axle
40	XA-V-1901-2	1	1	Axle (03 Series)
41	XB-21-S-375-3000	2	2	Rollpin .38" x 3"
42	XA-04681	1	1	Cushion Skid Foot (14 Series)
43	XB-04676	1	1	Rubber Cushion
44	XA-V-1938	1	1	Brace Lug
45	XA-LG0559	1	2	Bearing
46	XB-LG1570	1	2	Retainer
47	XB-767	3	2	Lube Fitting
48	XB-01789	1	1	Plastic Plug
49	XA-V-1914	1		Crank Hanger
50	XB-C-38-C-214	1		HHCS, 3/8" -16 x 2.25"
51	XB-1108	2		3/8" SAE Washer
52A	XA-V-90-0	1		Crank
52B	XA-V-90-2	1		Extra Long Crank (Optional)
53	XA-V-971	1		Crank Shaft Bracket (Optional)
54	XB-V-1915	1		Crank Hanger (Optional)
55	XA-V-1916	1		Extension Shaft - Long (Optional)
55	XA-V-1916-1	1		Extension Shaft - Short (Optional)
56	XA-V-630-2	1		Crank Shaft Coupling (Optional)
57	XB-V-444-1	2		HHCS, 3/8" -16 x 1.75" (Optional)
58	XB-338	2		Locknut, 3/8" -16 (Optional)
59	XB-GP-38-138-5	2		Groove Pin 3/8" x 1.38" (Optional)
60	XB-3103	3		Locknut 1/4" -28 (Optional)
61	XB-07618	3		HHCS, 1/4" -28 x 2.5" (Optional)
62A	XA-V-07601-1	1		Extension Bracket - Long (Optional)
62B	XA-V-07601-2	1		Extension Bracket - Short (Optional)

# Jost Landing Gear

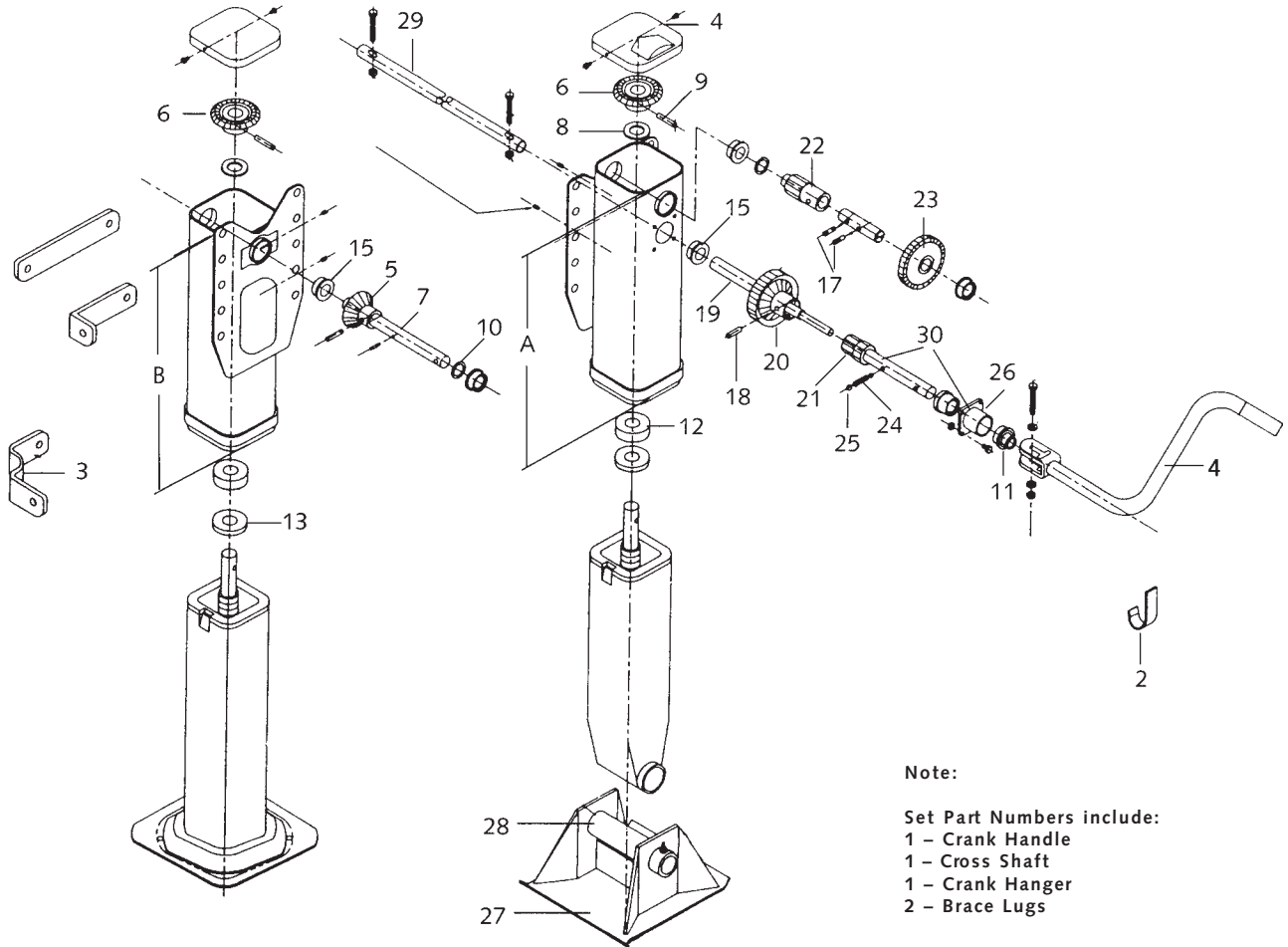

## JOST A400 MODEL Outside Mount

Set Part No.	Gear Box Leg Part No.	Non Gear Box Leg Part No.	Travel	Dimension A	Dimension B	Footware
JO-700-4-390S	JO-700-4-391GB	JO-700-4-392NGB	17"	29-1/2"	26-3/4"	4-1/2" x 10" x 10" Sand Shoe
JO-700-4-402S	JO-700-4-403GB	JO-700-4-404NGB	17"	29-1/2"	26-3/4"	10" x 10" Cushion Foot
JO-700-4-443S	JO-700-4-444GB	JO-700-4-445NGB	19"	31-1/2"	28-3/4"	4-1/2" x 10" x 10" Sand Shoe
JO-700-4-498S	JO-700-4-499GB	JO-700-4-500NGB	19"	31-1/2"	28-3/4"	10" x 10" Cushion Foot

## JOST A400 MODEL

Item No.	Part No.	Description
1	JO-C10592.2	Crank Handle
2	JO-B10261	Crank Hanger
3	JO-C10108	Brace Lug W
4	JO-C10217	Cover - Gear Box
5	JO-C10177	Pinion Gear
6	JO-C10155	Bevel Gear
7	JO-B10130	Pinion Shaft
11	JO-A10283	Grease Seal
15	JO-A10255	Bushing
17	JO-A10260.1	Spiral Pin 5/16" x 1-1/2"
18	JO-A10054.7	Roll Pin 3/8" x 1-3/4"
19	JO-B10236	Output Cluster Shaft
20	JO-C10234	Output Cluster Gear
21	JO-C10233	Input Gear Shaft
22	JO-C10078	Output Spur Gear
23	JO-C10085	Input Spur Gear
24	JO-A10049	Detent Spring
25	JO-A10048	Detent Ball
26	JO-B10229	Shift Housing
27	JO-C10035	Sand Shoe 4-1/2" x 10" x 10"
28	JO-B10036	Sand Shoe Axle
29	JO-B10066.77.4	Cross Shaft 68-1/2"
30	JO-B10285	Shifter Housing Assembly

# Jost Landing Gear

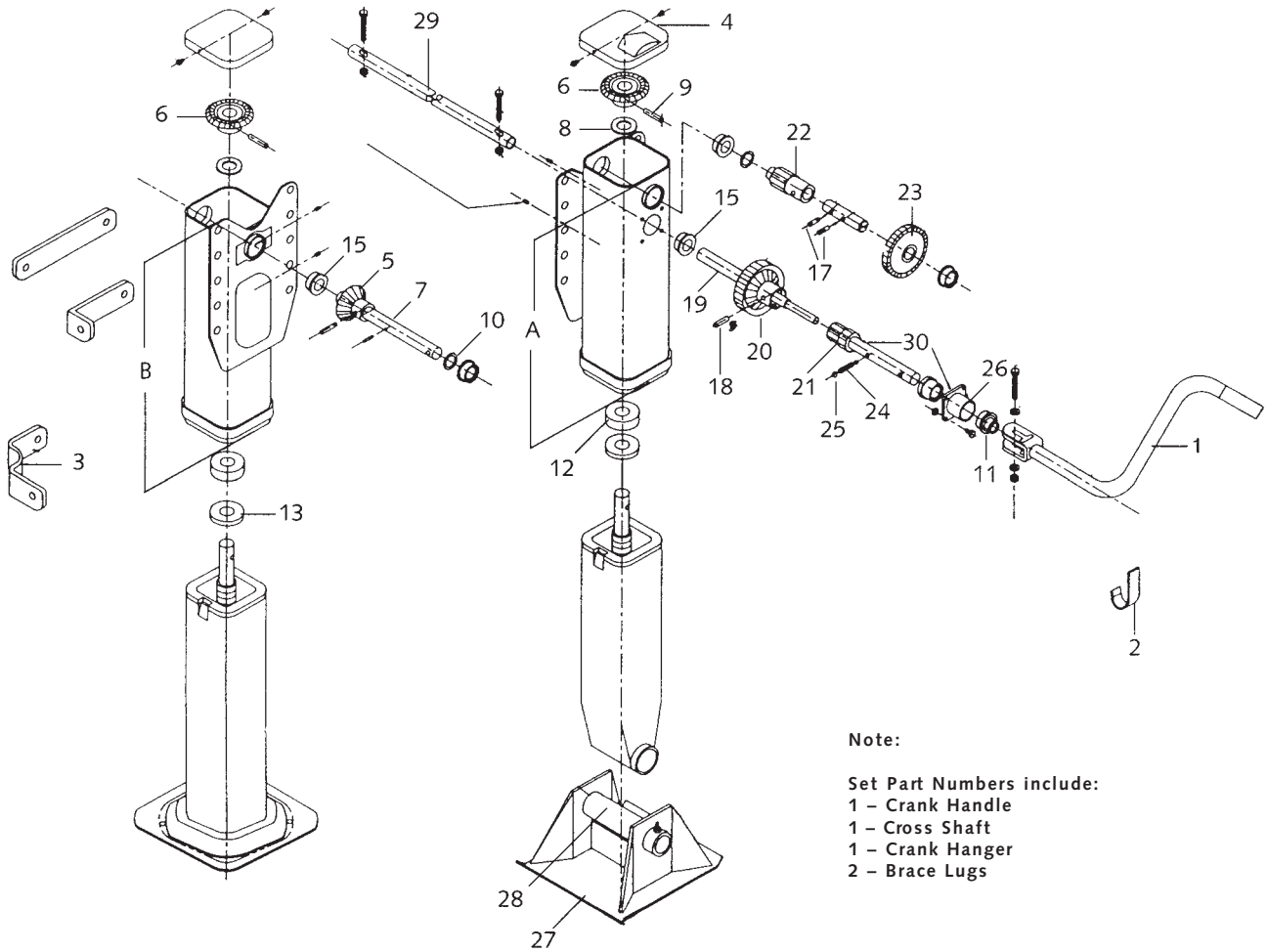

Note:

- Set Part Numbers include:  
 1 - Crank Handle  
 1 - Cross Shaft  
 1 - Crank Hanger  
 2 - Brace Lugs

## JOST A401 MODEL Inside Mount

Set Part No.	Gear Box Leg Part No.	Non Gear Box Leg Part No.	Travel	Dimension A	Dimension B	Footware
JO-700-4-393S	JO-700-4-394GB	JO-700-4-395NGB	17"	29-1/2"	26-3/4"	4-1/2" x 10" x 10" Sand Shoe
JO-700-4-410S	JO-700-4-411GB	JO-700-4-412NGB	17"	29-1/2"	26-3/4"	10" x 10" Cushion Foot

## JOST A401 MODEL

Item No.	Part No.	Description
1	JO-C10592.2	Crank Handle
2	JO-B10261	Crank Hanger
3	JO-C10108	Brace Lug W
4	JO-C10217	Cover - Gear Box
5	JO-C10177	Pinion Gear
6	JO-C10155	Bevel Gear
7	JO-B10130	Pinion Shaft
11	JO-A10283	Grease Seal
15	JO-A10255	Bushing
17	JO-A10260.1	Spiral Pin 5/16" x 1-1/2"
18	JO-A10054.7	Roll Pin 3/8" x 1-3/4"
19	JO-B10236	Output Cluster Shaft
20	JO-C10234	Output Cluster Gear
21	JO-C10233	Input Gear Shaft
22	JO-C10078	Output Spur Gear
23	JO-C10085	Input Spur Gear
24	JO-A10049	Detent Spring
25	JO-A10048	Detent Ball
26	JO-B10229	Shift Housing
27	JO-C10035	Sand Shoe 4-1/2" x 10" x 10"
28	JO-B10036	Sand Shoe Axle
29	JO-B10066.77.4	Cross Shaft 68-1/2"
30	JO-B10285	Shifter Housing Assembly



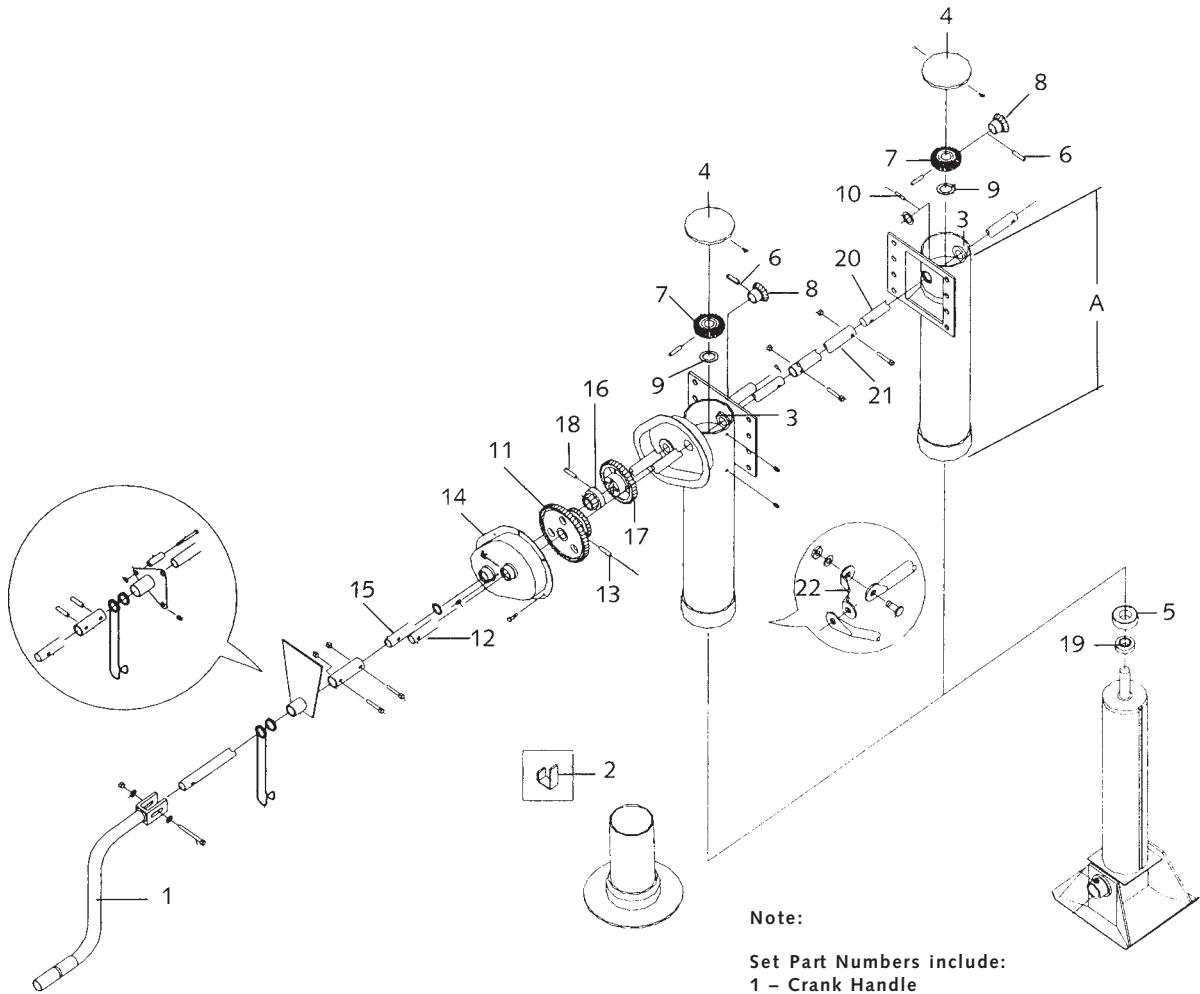

Note:

Set Part Numbers include:  
 1 - Crank Handle  
 1 - Cross Shaft  
 1 - Crank Hanger  
 2 - Brace Lugs

### AUSTIN-WESTRAN CMR MODEL Universal Mounting

Set Part No.	Gear Box Leg Part No.	Non Gear Box Leg Part No.	Travel	Dimension A	Footware
KW-700-4-358S	KW-700-4-359GB	KW-700-4-360NGB	16-7/8"	31"	10" Diameter Cushion Foot
KW-700-4-361S	KW-700-4-362GB	KW-700-4-363NGB	16-7/8"	27-1/2"	4-1/2" x 10" x 11-1/4" Sand Shoe
KW-700-4-454S	KW-700-4-455GB	KW-700-4-456NGB	16-7/8"	27-1/2"	2" x 10" x 10" Sand Shoe
KW-700-4-509S	KW-700-4-510GB	KW-700-4-511NGB	14-1/8"	28-1/4"	10" Diameter Cushion Foot

## AUSTIN-WESTRAN CMR MODEL

Item No.	Part No.	Description	Austin-Westran No.
1	KW-J-27-BX-3	Crank Handle	730113
2	KW-J-7153	Crank Hanger	750812
3	---	Bushing	724036
4	KW-751601	Cover	751601
5	TK-T127	Thrust Bearing	729005
6	KW-1453-A40	Roll Pin 3/8" x 1-3/8"	725002
7	---	Bevel Gear	730590
8	KW-J-5311-1	Pinion Gear	730011
9	---	Washer	722017
10	KW-1453-A1	Roll Pin 1/4" x 1-1/4"	725001
11	KW-J-5309	Gear	750009
12	KW-6948-1	Pinion Shaft	750002
13	KW-1453-A5	Roll Pin 3/8" x 1-1/2"	725003
14	KW-741158	Gear Box Cover	741158
15	KW-751175	Crank Shaft	751175
16	KW-751173	Gear - Low Speed	751173
17	KW-751174	Gear - High Speed	751174
18	---	Groove Pin 5/16" x 1-1/2"	725046
19	KW-J-4928-1	Collar	730007
20	KW-6956-1	Pinion Shaft	750004
21	KW-6884-70	Cross Shaft 66-7/8"	---
22	KW-J-4154	Brace Lug	730005

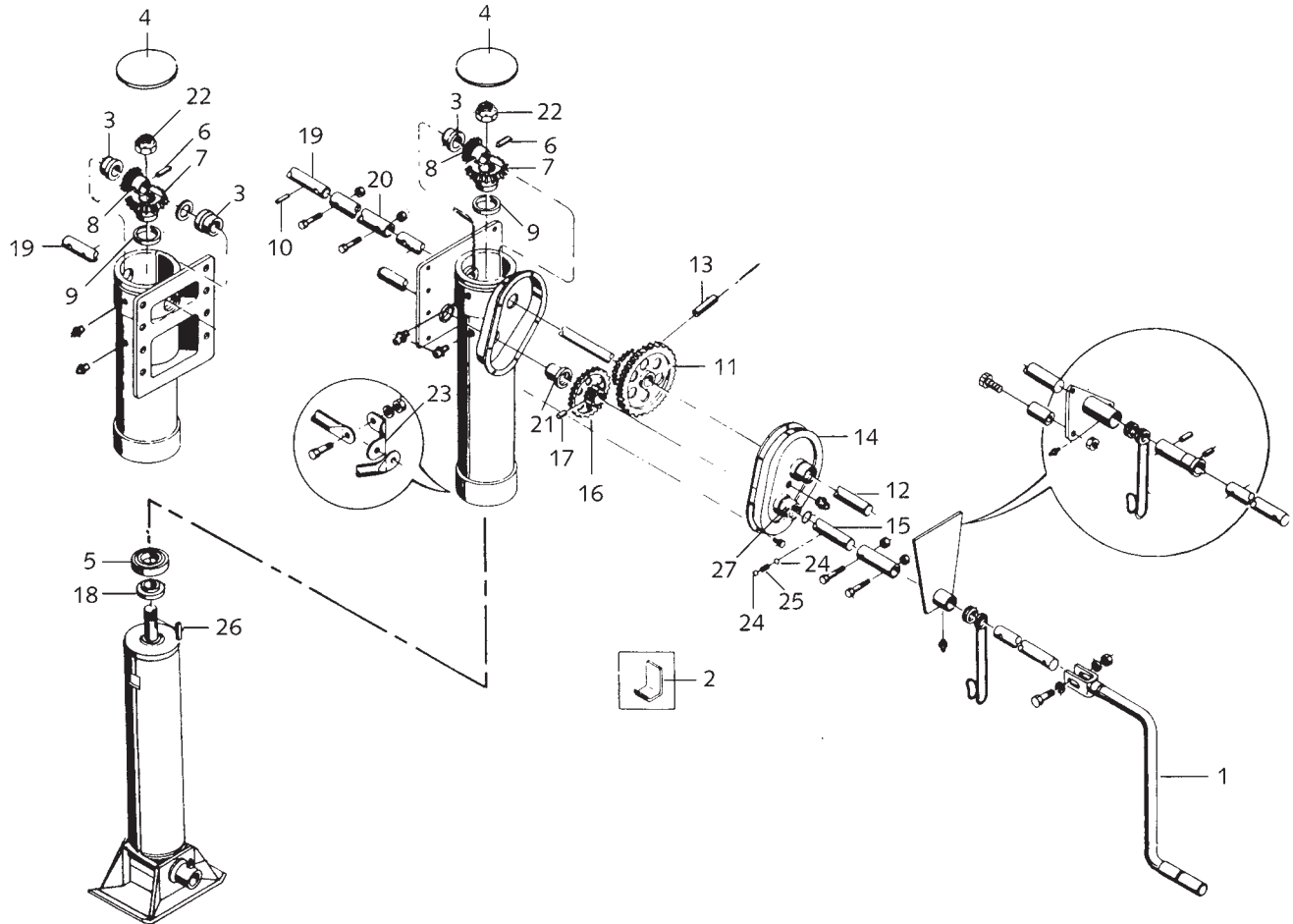

**AUSTIN-WESTRAN LPR MODEL  
Universal Mounting  
Manufactured before May 1996**

Note: Use CMR Model Parts Breakdown for LPR Models manufactured after May 1996	
Except:	
Omit: KW-75173 Low Speed Gear	Add: KW-J-5310-1 Gear
Omit: KW-75174 High Speed Gear	Add: KW-6943-2 Crank Shaft
Omit: KW-75175 Crank Shaft	Add: KW-9366-3 Gear Box Cover
Omit: KW-741158 Gear Box Cover	Add: KW-6365-1 Detent Spring
Omit: 725046 Groove Pin	Add: KW-1050-A1 Detent Ball
	Add: KW-1453-A61 Roll Pin

## AUSTIN-WESTRAN LPR MODEL

Item No.	Part No.	Description	Austin-Westran No.
1	KW-J-27-BX-3	Crank Handle	730113
2	KW-J-7153	Crank Hanger	750812
3	KW-8994	Bushing	724003
4	KW-8984	Cover	750109
5	TK-T127	Thrust Bearing	729005
6	KW-1453-A40	Roll Pin 3/8" x 1-3/8"	725002
7	KW-J-5312-1	Bevel Gear	750355
8	KW-J-5311-1	Pinion Gear	730011
9	KW-J-5313	Bushing	724000
10	KW-1453-A1	Roll Pin 1/4" x 1-1/4"	725001
11	KW-J-5309	Gear	750009
12	KW-6948-1	Pinion Shaft	750002
13	KW-1453-A5	Roll Pin 3/8" x 1-1/2"	725003
14	KW-9366-3	Gear Box Cover	740001
15	KW-6943-2	Crank Shaft	750003
16	KW-J-5310-1	Gear	750010
17	KW-1453-A61	Roll Pin 5/16" x 1-1/4"	725015
18	KW-J-4928-1	Collar	730007
19	KW-6956-1	Pinion Shaft	750004
20	KW-6884-70	Cross Shaft 66-7/8"	---
21	KW-6364-1	Bushing	724001
22	KW-1402-A7	Lock Nut 1"	723001
23	KW-J-4154	Brace Lug	730005
24	KW-1051-A1	Detent Ball	729001
25	KW-6365-1	Detent Spring	729000
26	KW-J-3237	Key 1/4" x 13/16"	729003
27	KW-6363-1	Bushing	724002

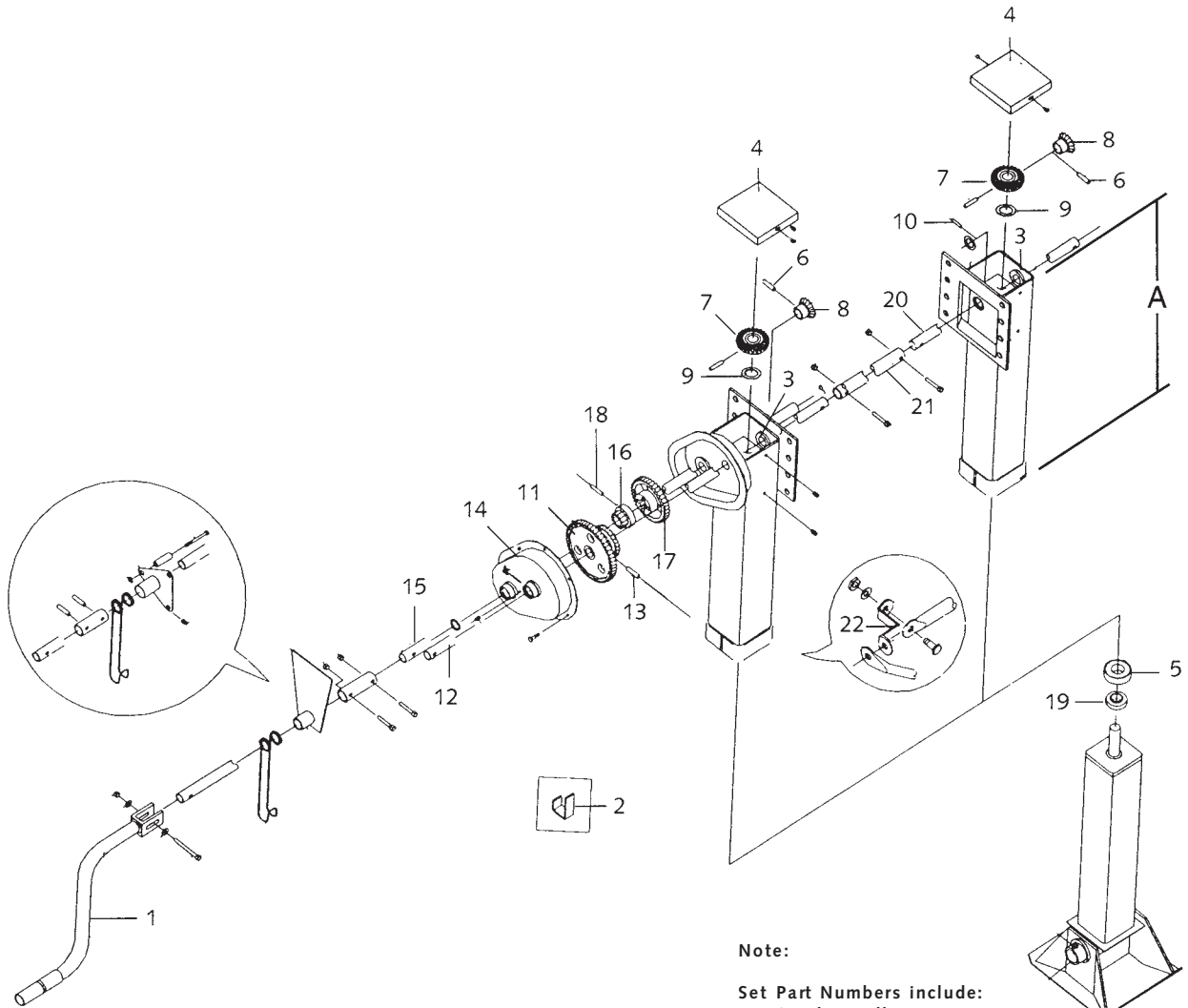

Note:

- Set Part Numbers include:  
 1 - Crank Handle  
 1 - Cross Shaft  
 1 - Crank Hanger  
 2 - Brace Lugs

## AUSTIN-WESTRAN CMS MODEL Universal Mounting

Set Part No.	Gear Box Leg Part No.	Non Gear Box Leg Part No.	Travel	Dimension A	Footware
KW-700-4-372S	KW-700-4-373GB	KW-700-4-374NGB	16-1/2"	27-1/2"	4-1/2" x 10" x 11-1/4" Sand Shoe

## AUSTIN-WESTRAN CMS MODEL

Item No.	Part No.	Description	Austin-Westran No.
1	KW-J-27-BX-3	Crank Handle	730113
2	KW-J-7153	Crank Hanger	750812
3	---	Bushing	724037
4	---	Cover	751569
5	TK-T127	Thrust Bearing	729005
6	KW-1453-A40	Roll Pin 3/8" x 1-3/8"	725002
7	---	Bevel Gear	730590
8	KW-J-5311-1	Pinion Gear	730011
9	---	Washer	722017
10	KW-1453-A1	Roll Pin 1/4" x 1-1/4"	725001
11	KW-J-5309	Gear	750009
12	KW-6948-1	Pinion Shaft	750002
13	KW-1453-A5	Roll Pin 3/8" x 1-1/2"	725003
14	KW-741158	Gear Box Cover	741158
15	KW-751175	Crank Shaft	751175
16	KW-751173	Gear - Low Speed	751173
17	KW-751174	Gear - High Speed	751174
18	---	Groove Pin 5/16" x 1-1/2"	725046
19	KW-J-4928-1	Collar	730007
20	KW-6956-1	Pinion Shaft	750004
21	KW-6884-70	Cross Shaft 66-7/8"	---
22	KW-J-4890	Brace Lug	730157

# Austin-Westran Landing Gear

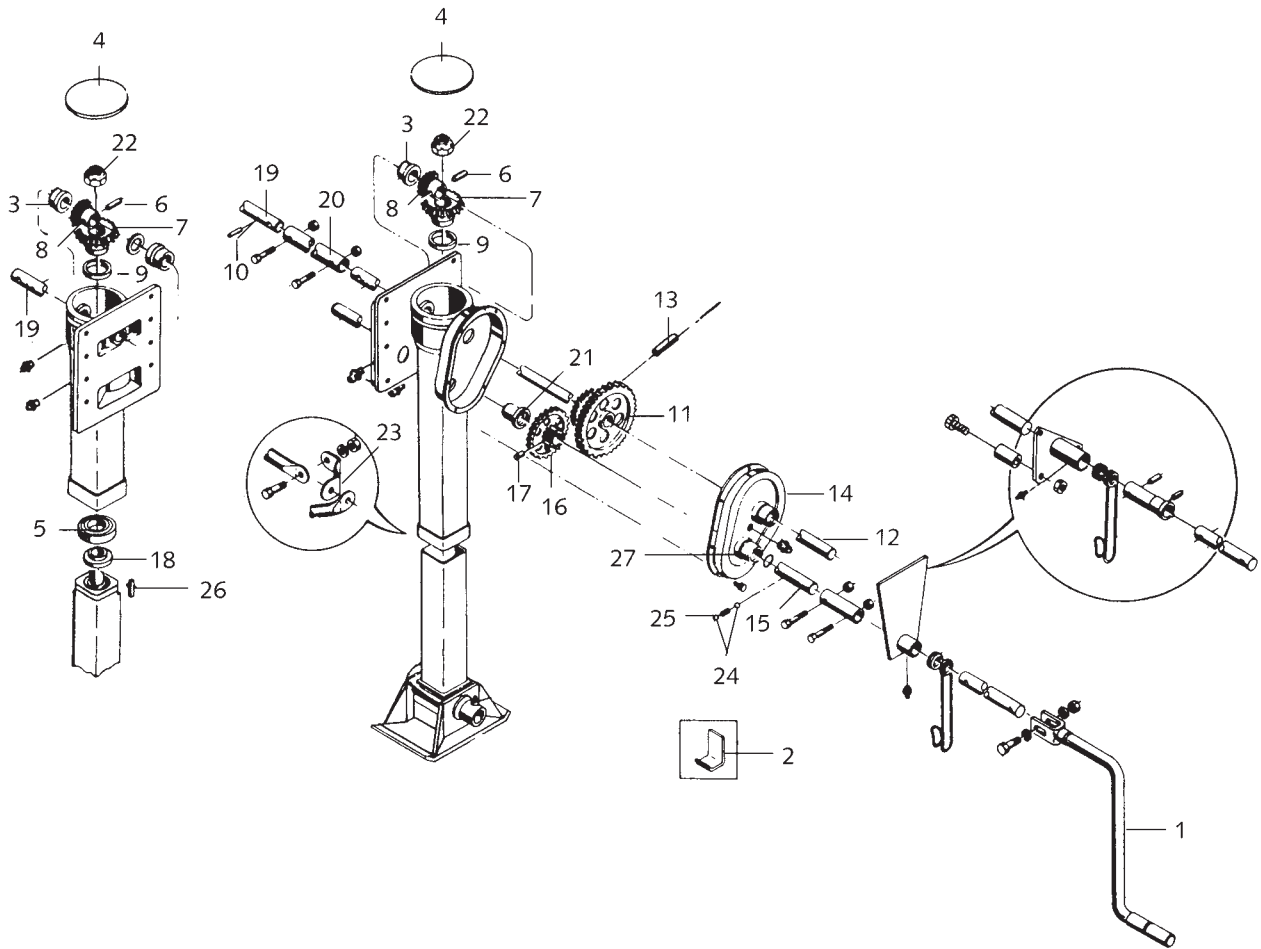

**AUSTIN-WESTRAN LPS MODEL  
Universal Mounting  
Manufactured before May 1996**

Note: Use CMS Model Parts Breakdown for LPS Models manufactured after May 1996	
Except:	
Omit: KW-75173 Low Speed Gear	Add: KW-J-5310-1 Gear
Omit: KW-75174 High Speed Gear	Add: KW-6943-2 Crank Shaft
Omit: KW-75175 Crank Shaft	Add: KW-9366-3 Gear Box Cover
Omit: KW-741158 Gear Box Cover	Add: KW-6365-1 Detent Spring
Omit: 725046 Groove Pin	Add: KW-1050-A1 Detent Ball
	Add: KW-1453-A61 Roll Pin

## AUSTIN-WESTRAN LPS MODEL

Item No.	Part No.	Description	Austin-Westran No.
1	KW-J-27-BX-3	Crank Handle	730113
2	KW-J-7153	Crank Hanger	750812
3	KW-8994	Bushing	724003
4	KW-8984	Cover	750109
5	TK-T127	Thrust Bearing	729005
6	KW-1453-A40	Roll Pin 3/8" x 1-3/8"	725002
7	KW-J-5312-1	Bevel Gear	750355
8	KW-J-5311-1	Pinion Gear	730011
9	KW-J-5313	Bushing	724000
10	KW-1453-A1	Roll Pin 1/4" x 1-1/4"	725001
11	KW-J-5309	Gear	750009
12	KW-6948-1	Pinion Shaft	750002
13	KW-1453-A5	Roll Pin 3/8" x 1-1/2"	725003
14	KW-9366-3	Gear Box Cover	740001
15	KW-6943-2	Crank Shaft	750003
16	KW-J-5310-1	Gear	750010
17	KW-1453-A61	Roll Pin 5/16" x 1-1/4"	725015
18	KW-J-4928-1	Collar	730007
19	KW-6956-1	Pinion Shaft	750004
20	KW-6884-70	Cross Shaft 66-7/8"	---
21	KW-6364-1	Bushing	724001
22	KW-1402-A7	Lock Nut 1"	723001
23	KW-J-4890	Brace Lug	730157
24	KW-1051-A1	Detent Ball	729001
25	KW-6365-1	Detent Spring	729000
26	KW-J-3237	Key 1/4" x 13/16"	729003
27	KW-6363-1	Bushing	724002



# Mounting Brackets

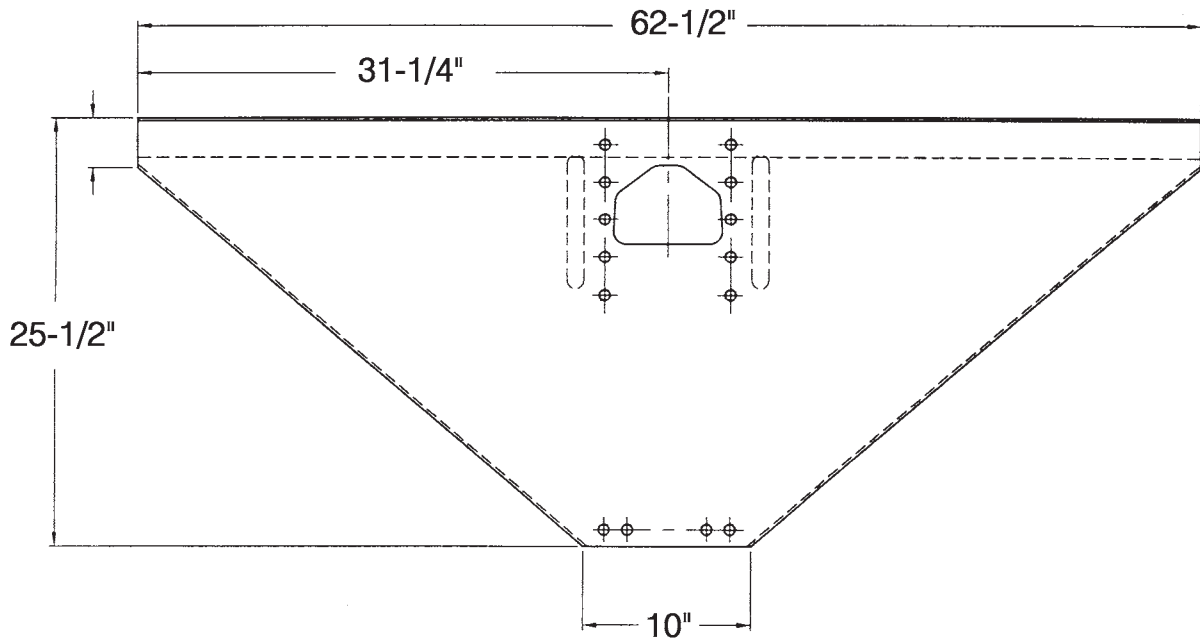

## Trailmobile Deep Mounting Bracket

4-A1-223

Generic 700-4-507

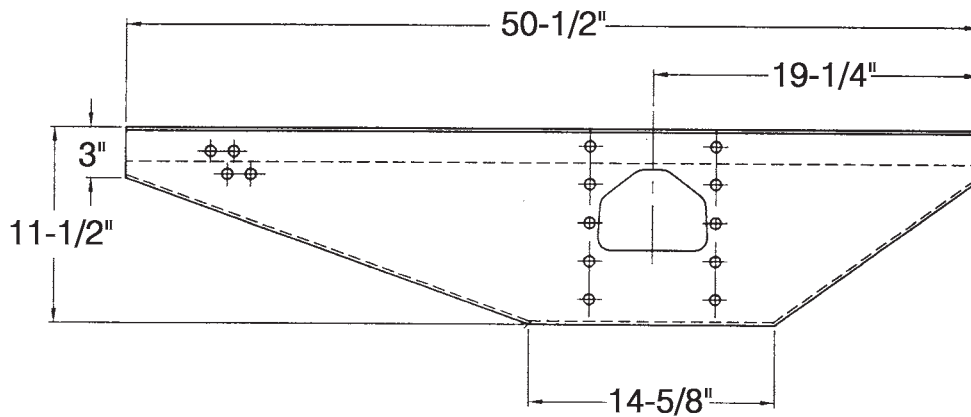

R.H. Shown

## Trailmobile Shallow Mounting Brackets

4-A1-224L L.H.

4-A1-224R R.H.

Generic 700-4-508L

Generic 700-4-508R

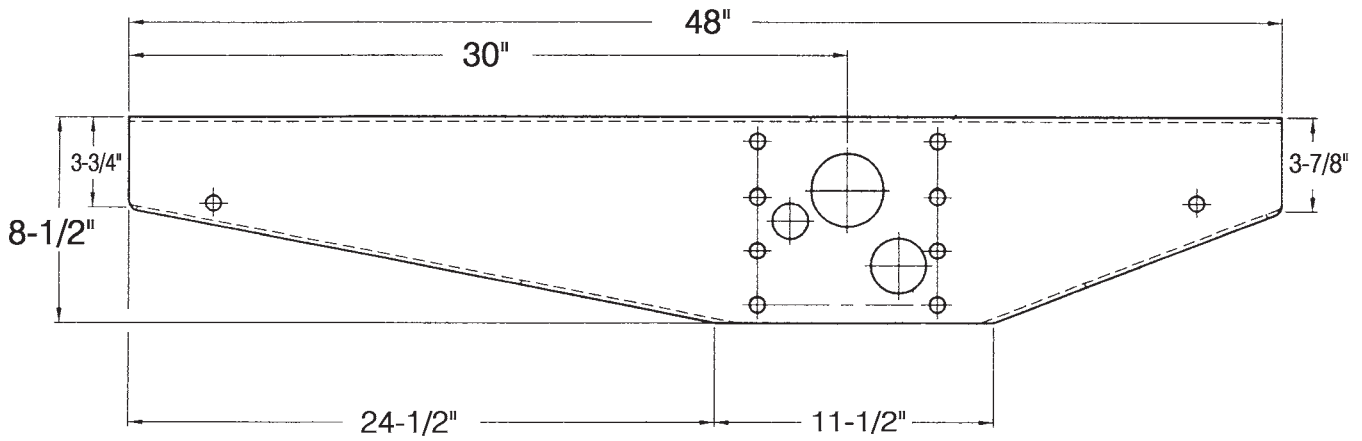

R.H. Shown

## Wabash Style Mounting Brackets

700-4-420L L.H.  
Replaces 13S00047

700-4-420R R.H.  
Replaces 13S00048

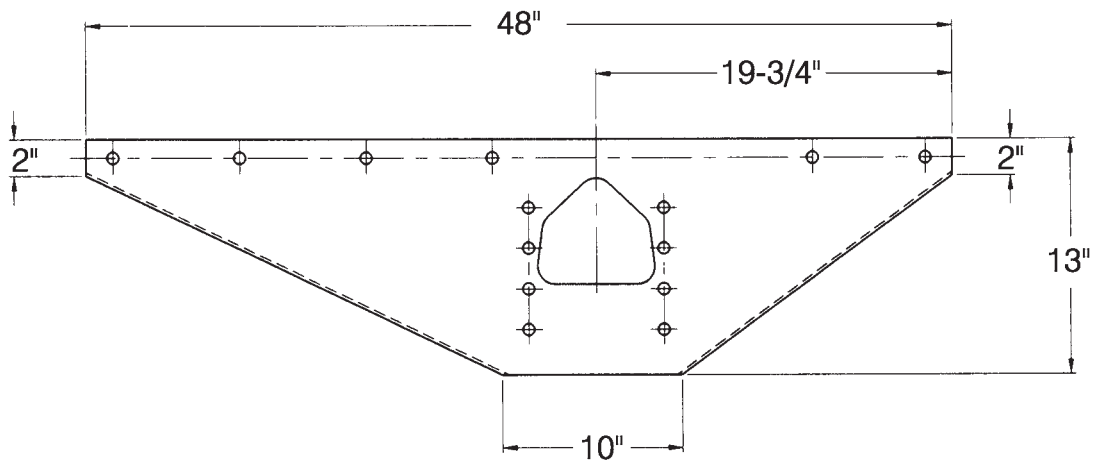

R.H. Shown

## Great Dane Style Mounting Brackets

700-4-502L L.H.  
Replaces 13647

700-4-502R R.H.  
Replaces 13646

# Mounting Brackets

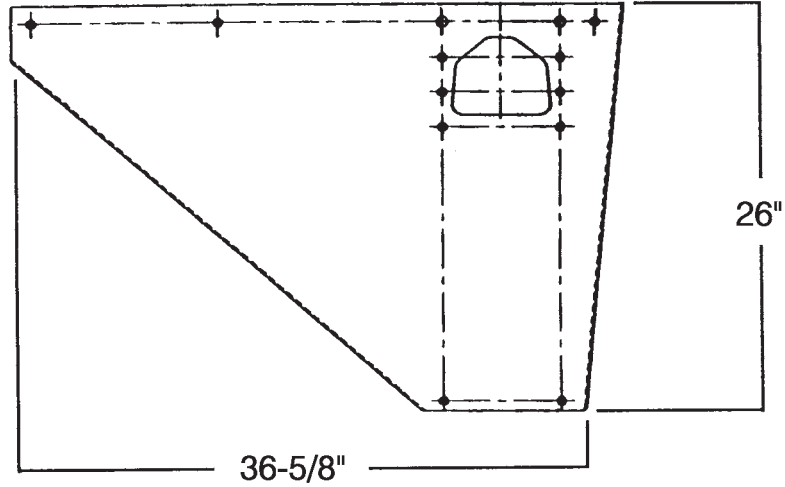

R.H. Shown

## Pines Style Mounting Brackets

700-4-421L L.H.  
Replaces LGB1314L

700-4-421R R.H.  
Replaces LGB1314R

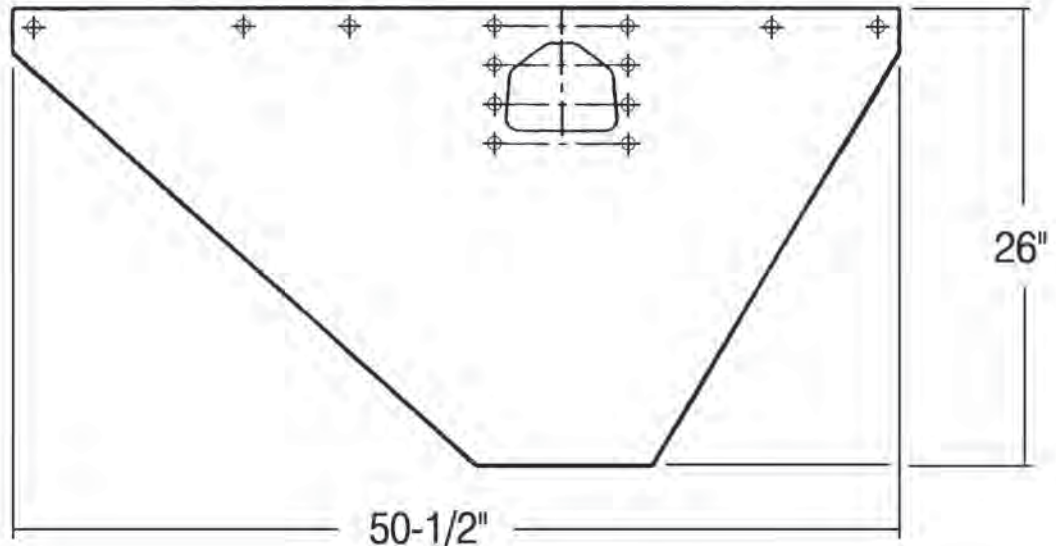

R.H. Shown

## Pines Style Mounting Brackets

700-4-422L L.H.  
Replaces LGB1315L

700-4-422R R.H.  
Replaces LGB1315R

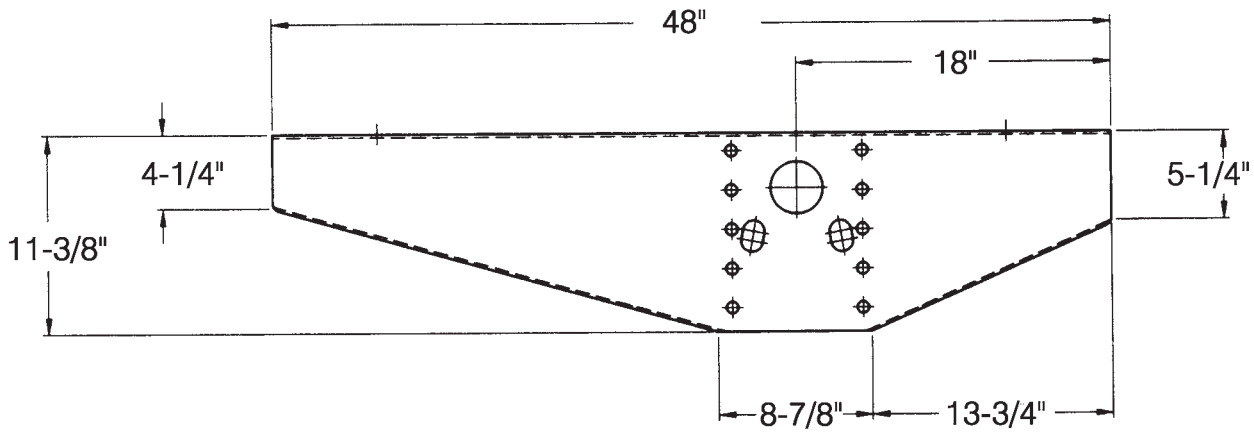

R.H. Shown

## Monon Style Mounting Brackets

700-4-501L L.H.  
Replaces V09-189A-RS

700-4-501R R.H.  
Replaces V09-189B-RS

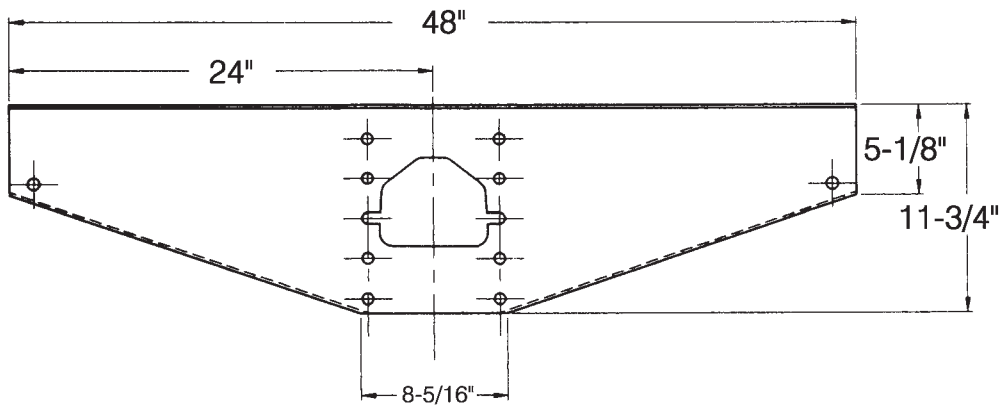

## Miller Style Mounting Bracket

700-4-481  
Universal left or right

# Mounting Brackets

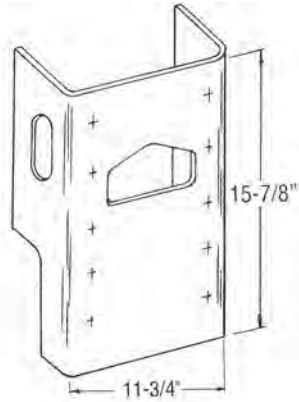

**Trailmobile Flatbed Mounting Bracket**  
4-A1-264

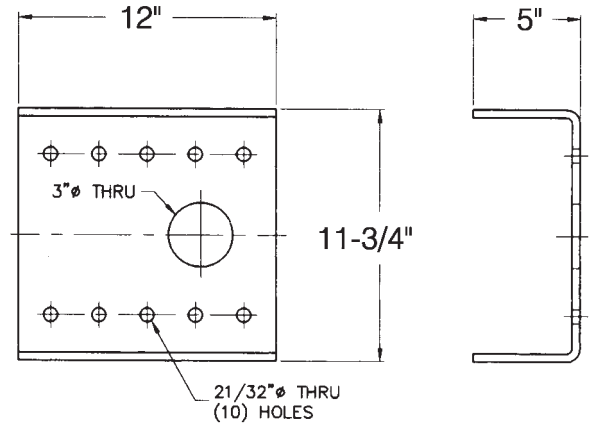

**ACL Style Flatbed Mounting Bracket**  
700-4-457  
Replaces Penz 02-03

## Bracing

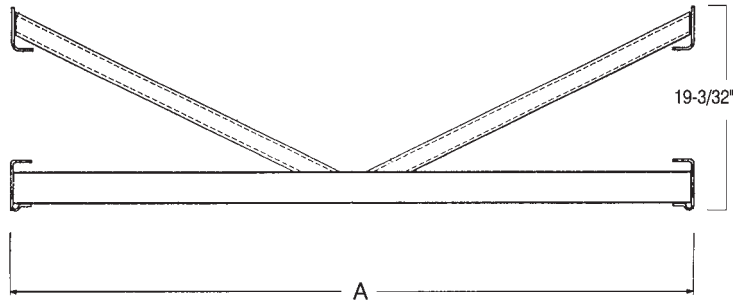

**Trailmobile Prop Brace Assemblies**

4-A8-9  
A = 63-5/8"

4-A8-9-1  
A = 69-5/8"

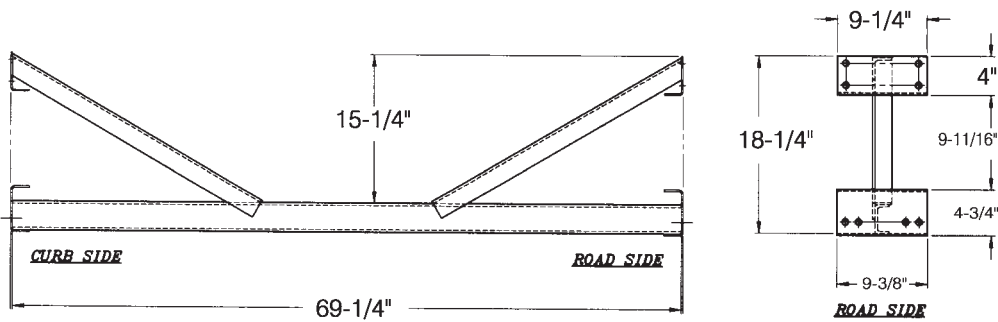

**Universal K-Brace**  
700-4-503  
For 102" Wide Trailers

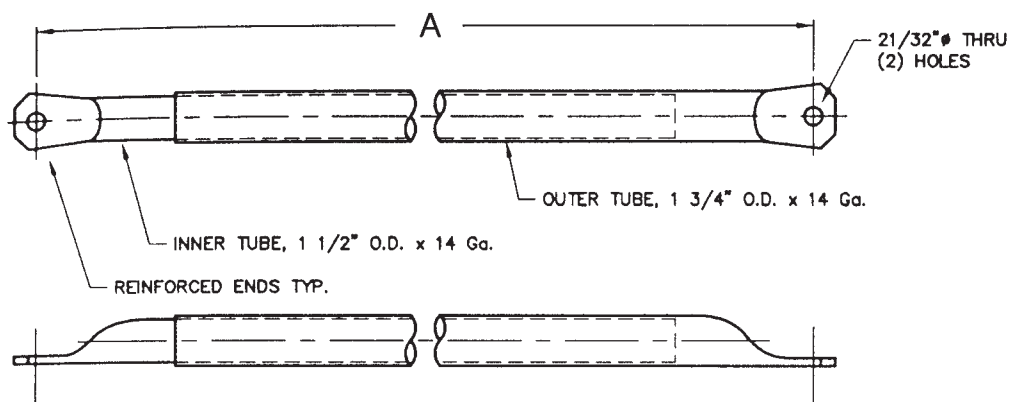

## 2-Piece Standard Duty Adjustable Braces

700-4-133

A = 26" to 41"

700-4-134

A = 42" to 57"

700-4-135

A = 56" to 72"

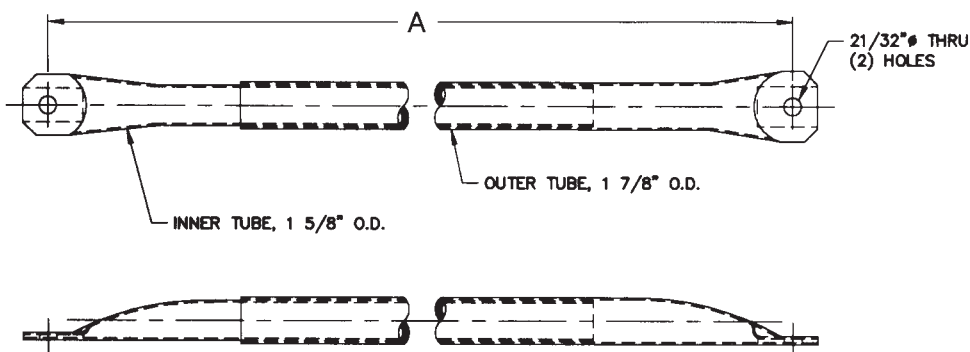

## 2-Piece Heavy Duty Adjustable Brace

PZ-04-40-56-72

A = 56" to 72"

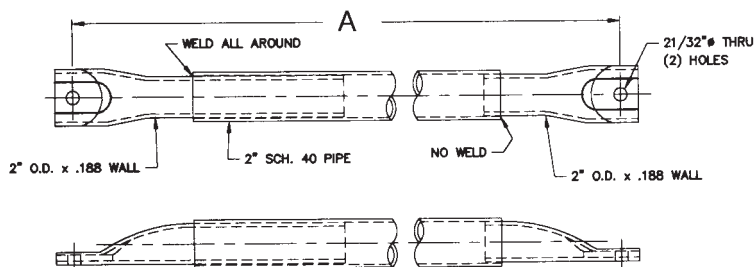

## 2-Piece Super Heavy Duty Adjustable Braces

PZ-04-80-26-41

A = 26" to 41"

PZ-04-80-56-72

A = 56" to 72"

## BRACE LUGS

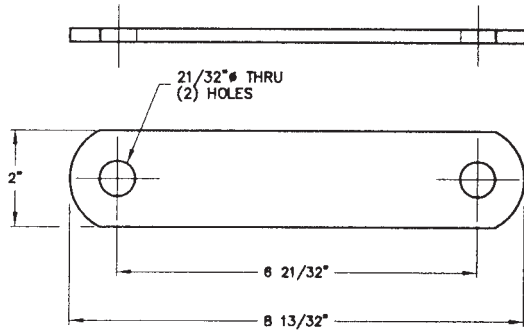

700-4-407

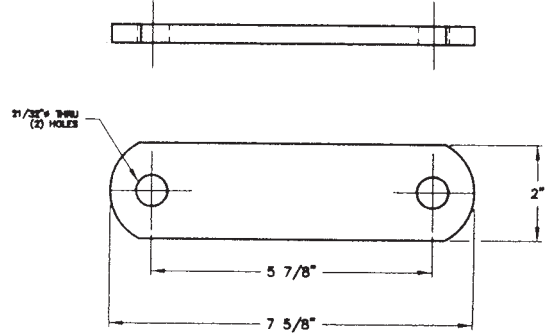

700-4-408

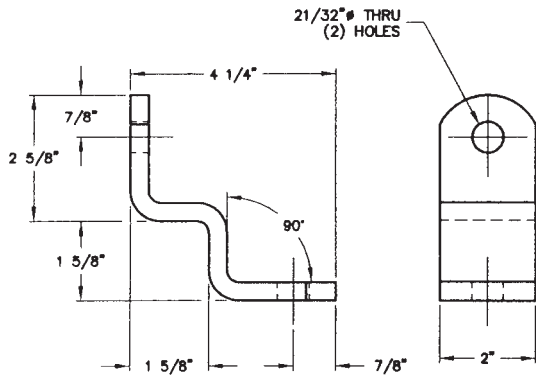

700-4-96

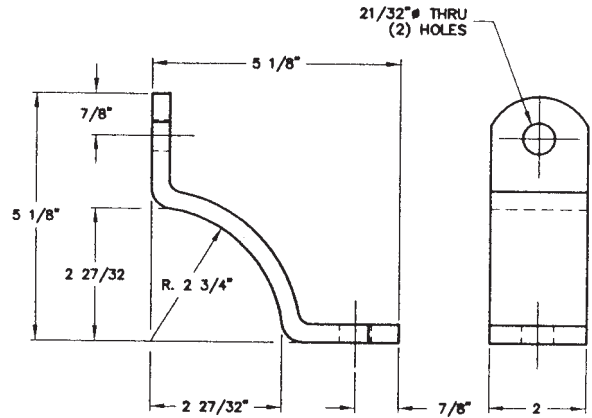

700-4-39

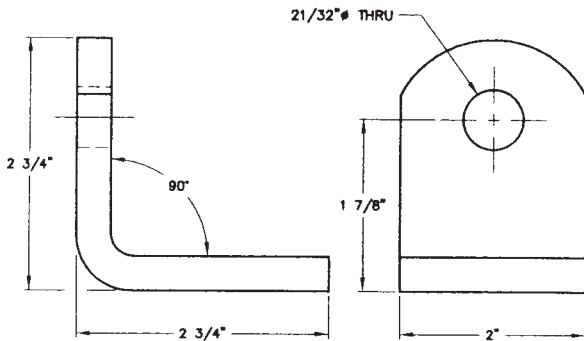

700-4-93

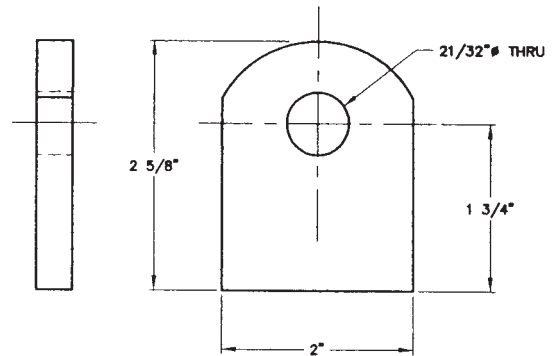

700-4-92

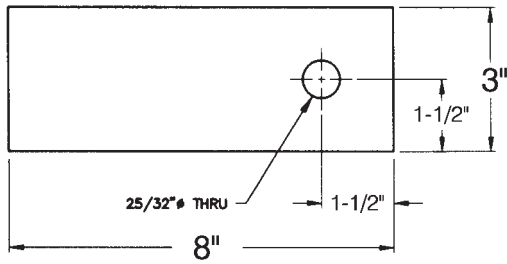

**Lower Brace Lug**  
700-4-451  
Replaces Great Dane 09954

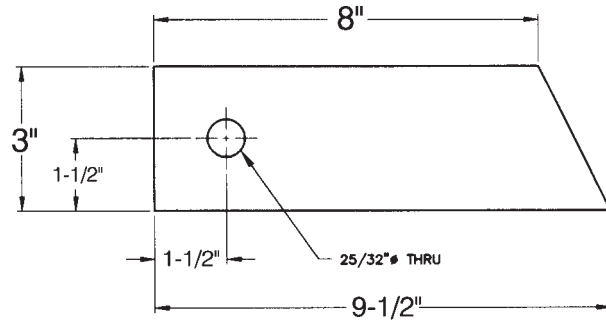

**Upper Brace Lug**  
700-4-452  
Replaces Great Dane 09955

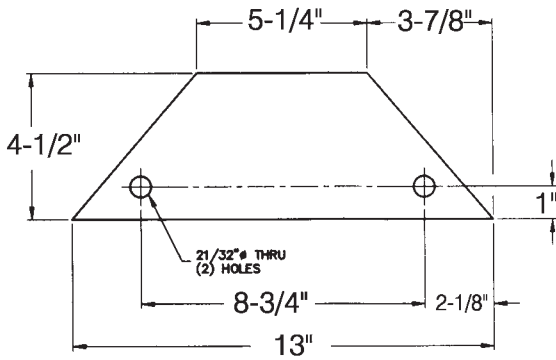

**Mounting Plate**  
700-4-450  
Replaces Great Dane 09758



# Sand Shoes



## SAND SHOES

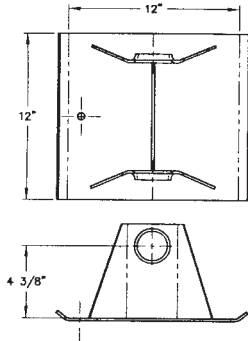

**700-4-2**  
Sides - 1/4"  
Base - 7Gauge  
Single Gusset

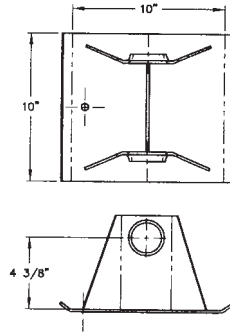

**700-4-316**  
Sides - 1/4"  
Base - 7Gauge  
Single Gusset

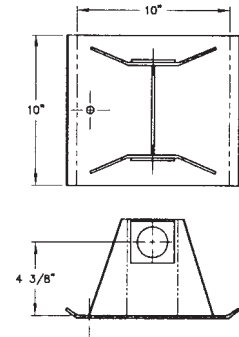

**700-4-424**  
Sides - 1/4"  
Base - 7Gauge  
Single Gusset

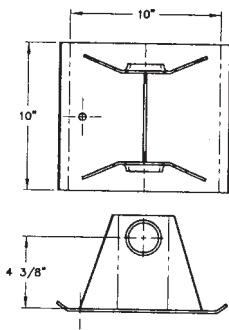

**700-4-340**  
Sides - 7Gauge  
Base - 7Gauge  
Single Gusset

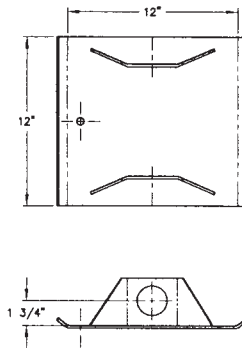

**700-4-101**  
Sides - 1/4"  
Base - 7Gauge  
No Gusset

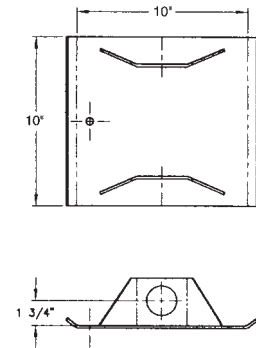

**700-4-409**  
Sides - 1/4"  
Base - 7Gauge  
No Gusset

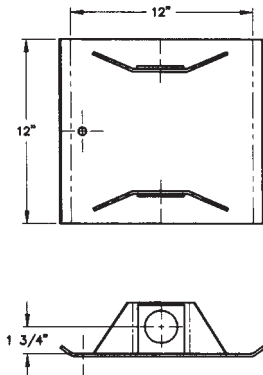

**700-4-474**  
Sides - 7Gauge  
Base - 7Gauge  
No Gusset

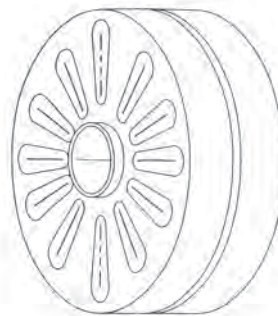

**4-10-55**  
Wheel Dia. - 9"  
Hole Size - 2-1/32"  
Width - 3-3/16"

## SAND SHOE AXLE KITS

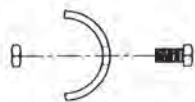
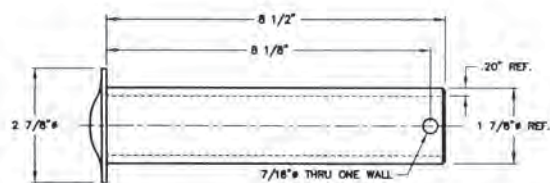

**700-4-111**

Material - Schedule 80

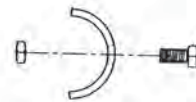
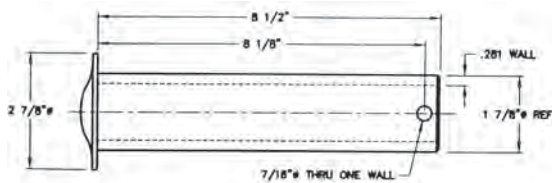

**700-4-112**

Heavy Duty  
Material - Schedule 160

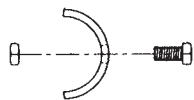
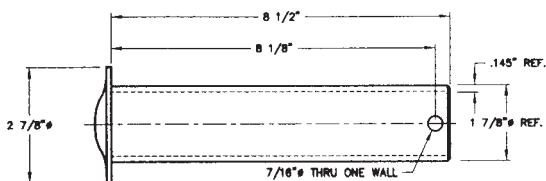

**700-4-406**

Material - Schedule 40

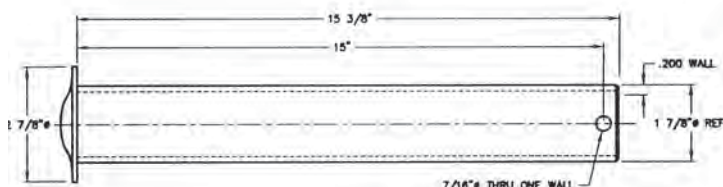

**700-4-113**

Material - Schedule 80

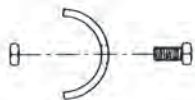
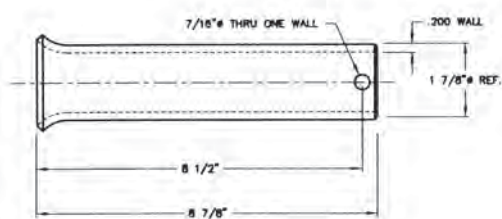

**700-4-110**

Material - Schedule 80



**Axle Collar**

700-4-116



**Axle Housing**

700-4-109

## CUSHION FOOT KITS



**Replacement Kit for  
Propar/Eagle**  
700-4-434



**Replacement Kit for  
FG4000 Fast Gear  
& 51,000 Contender**  
BK-LG0048-01

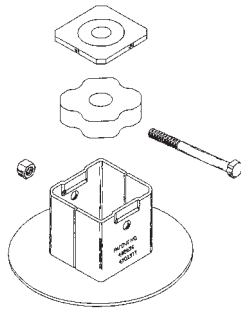

**Replacement Kit for  
50,000 Challenger**  
BK-LG0068  
10" Diameter



**Repair Kit for  
Jost**  
JO-C10717

## Vertical Fold - Clearance for 1" Shaft

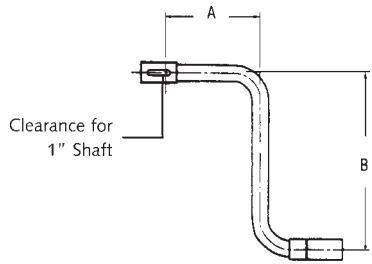

Part No.	Dimension A	Dimension B
700-4-140	7-3/8"	14"
700-4-141	11-3/8"	
700-4-142	15-3/8"	
700-4-173	21"	

## Vertical Fold - Clearance for 7/8" Shaft

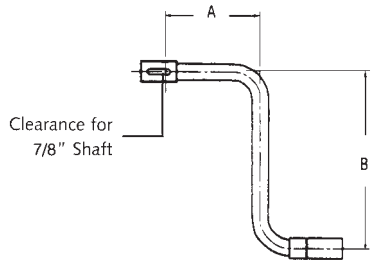

Part No.	Dimension A	Dimension B	Replacement For
700-4-441	12-9/16"	12	SXA000250-3

## Side Fold - Clearance for 1" Shaft

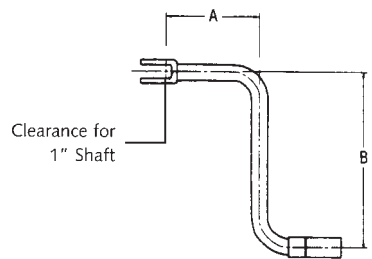

Part No.	Dimension A	Dimension B
700-4-136	7-3/8"	14"
700-4-137	11-3/8"	
700-4-138	15-3/8"	
700-4-139	21"	



**Wire Crank Handle Hook**  
BK-XB-LG0089



**Propar / Eagle Gear Kit**  
EG-JBP-GEARKIT

# Miscellaneous

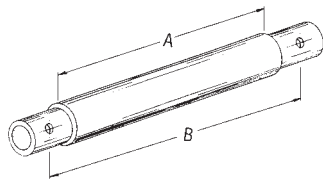

**Adjustable Cross Shaft**  
**700-4-97**  
 A = 52"  
 B = 53" to 72"



**Support Leg Bolt Kit**  
**700-50-35**  
 Contains:  
 10-5/8" x 1-3/4" Grade 8 Bolts  
 10-5/8" Lock Nuts

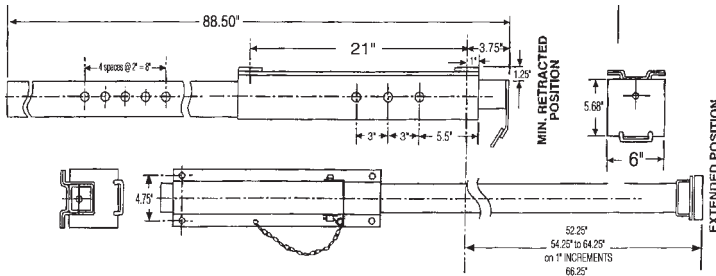

**Anti-Nose-Dive Jack**  
**BK-LG1870**



**Anti-Nose-Dive Pin Assembly**  
**4-A23-7**  
 1/2" Diameter Pin

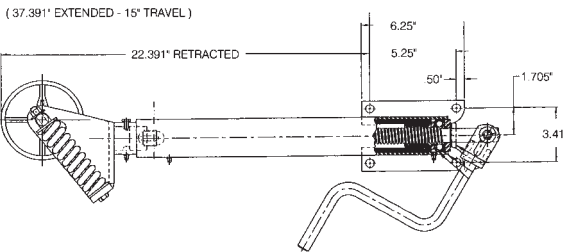

**Holland Converter Dolly Jack**  
**HL-JS-300-J**  
 15" Travel; 5" Steel Wheel



**Austin-Westran Converter Dolly Jack**  
**KW-760107**  
 12-1/2" Travel; 8" Textite Wheel



**Butler Converter Dolly Jack**  
**21-A5-11**  
 12-1/2" Travel; 6" Steel Wheel



**Butler Stabilizing Jack**  
**BP-ST-100**  
 Adjusts 44" to 51"

## AUSTIN-WESTRAN CMR MODEL

AUSTIN-WESTRAN PART NO.	TRAILMOBILE PART NO.
795098	KW-700-4-358S
742315	KW-700-4-359GB
742124	KW-700-4-360NGB
795118	KW-700-4-361S
742379	KW-700-4-362GB
742109	KW-700-4-363NGB
795095	KW-700-4-454S
742189	KW-700-4-455GB
742113	KW-700-4-456NGB
795179	KW-700-4-509S
742836	KW-700-4-510GB
742340	KW-700-4-511NGB

## AUSTIN-WESTRAN CMS MODEL

AUSTIN-WESTRAN PART NO.	TRAILMOBILE PART NO.
785078	KW-700-4-372S
742523	KW-700-4-373GB
742118	KW-700-4-374NGB

## BUTLER 26100 VOYAGER MODEL

BUTLER PART NO.	TRAILMOBILE PART NO.
26110	BP-700-4-364S
26111	BP-700-4-365GB
26112	BP-700-4-366NGB

## HOLLAND MARK V MODEL

HOLLAND PART NO.	TRAILMOBILE PART NO.
LGS-3A001	HL-700-4-378S
XA-S8-3A001	HL-700-4-379GB
XA-S9-3A001	HL-700-4-380NGB
LGS-3A105	HL-700-4-381S
XA-S8-3A105	HL-700-4-382GB
XA-S9-3A105	HL-700-4-383NGB
LGS-4A001	HL-700-3-384S
XA-S8-4A001	HL-700-3-385GB
XA-S9-4A001	HL-700-3-386NGB
LGS-4A105	HL-700-4-387S
XA-S8-4A105	HL-700-4-388GB
XA-S9-4A105	HL-700-4-389NGB

## HOLLAND BINKLEY 50,000 CHALLENGER MODEL

HOLLAND BINKLEY PART NO.	TRAILMOBILE PART NO.
LG5001-30	BK-700-4-349S
LG5001-32	BK-700-4-350GB
LG5001-31	BK-700-4-351NGB
LG5001-70	BK-700-4-179S
LG5001-72	BK-700-4-180GB
LG5001-71	BK-700-4-181NGB
LG5001-90	BK-4-A5-380S
LG5001-92	BK-4-A5-381GB
LG5001-91	BK-4-A5-382NGB
LG5008-70	BK-700-4-342S
LG5008-72	BK-700-4-343GB
LG5008-71	BK-700-4-344NGB
LG5G0C-90	BK-700-4-416S
LG5G0C-92	BK-700-4-417GB
LG5G0C-91	BK-700-4-418NGB

## HOLLAND BINKLEY 51,000 CONTENDER MODEL

HOLLAND BINKLEY PART NO.	TRAILMOBILE PART NO.
LG400B-70	BK-700-4-345S
LG400B-72	BK-700-4-346GB
LG400B-71	BK-700-4-347NGB
LG400B-705	BK-700-4-369S
LG400B-725	BK-700-4-370GB
LG400B-715	BK-700-4-371NGB
LG400K-70	BK-700-4-272S
LG400K-72	BK-700-4-273GB
LG400K-71	BK-700-4-274NGB
LG4003-70	BK-700-4-485S
LG4003-72	BK-700-4-486GB
LG4003-71	BK-700-4-487NGB
LG4003-90	BK-700-4-425S
LG4003-92	BK-700-4-426GB
LG4003-91	BK-700-4-427NGB

## HOLLAND BINKLEY FG4000 FAST GEAR MODEL

HOLLAND BINKLEY PART NO.	TRAILMOBILE PART NO.
FG400B-70	BK-700-4-413S
FG400B-72	BK-700-4-414GB
FG400B-71	BK-700-4-415NGB
FG400B-705Q	BK-700-4-478S
FG400B-725Q	BK-700-4-479GB
FG400B-715Q	BK-700-4-480NGB
FG4003-70	BK-700-4-495S
FG4003-72	BK-700-4-496GB
FG4003-71	BK-700-4-497NGB



# Cross Reference



## JUST A400 MODEL

JUST PART NO.	TRAILMOBILE PART NO.
A400G17	JO-700-4-402S
A400RG17	JO-700-4-403GB
A400LG17	JO-700-4-404NGB
A400G19	JO-700-4-498S
A400RG19	JO-700-4-499GB
A400LG19	JO-700-4-500NGB
A400T17	JO-700-4-390S
A400RT17	JO-700-4-391GB
A400LT17	JO-700-4-392NGB
A400T19	JO-700-4-443S
A400RT19	JO-700-4-444GB
A400LT19	JO-700-4-445NGB

## JUST A401 MODEL

JUST PART NO.	TRAILMOBILE PART NO.
A401G317	JO-700-4-410S
A401RG317	JO-700-4-411GB
A401LG317	JO-700-4-412NGB
A401T17	JO-700-4-393S
A401RT17	JO-700-4-394GB
A401LT17	JO-700-4-395NGB



# Couplers and Hitches

---

<b>UPPER COUPLERS</b> .....	<b>6-1</b>
<b>KING PINS</b> .....	<b>6-2</b>
<b>KING PIN LOCKS</b> .....	<b>6-2</b>
<b>PINTLE HOOKS &amp; EYES</b> .....	<b>6-3</b>
<b>MISCELLANEOUS</b> .....	<b>6-4</b>

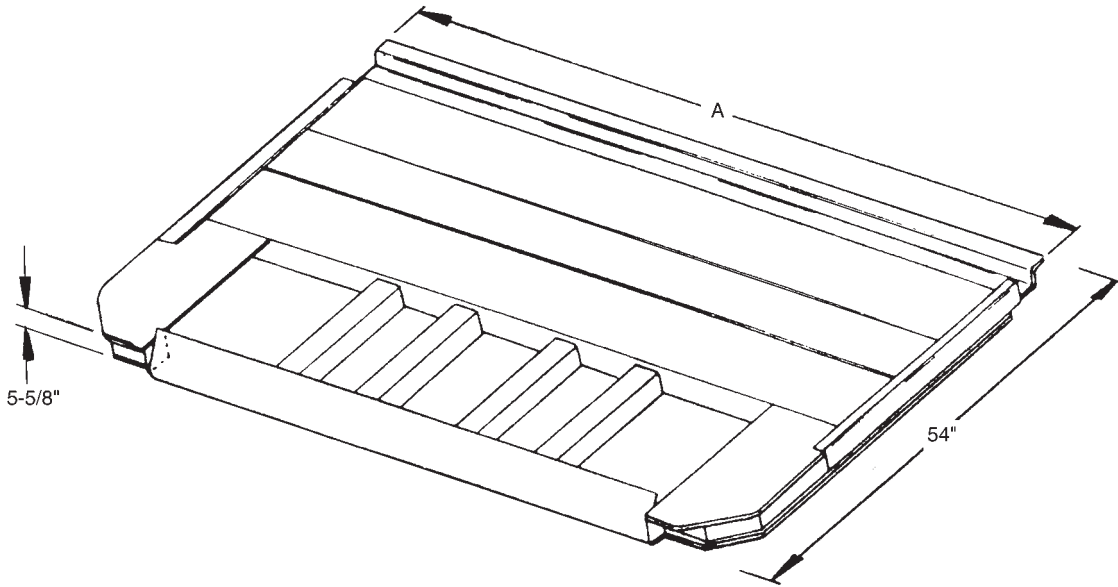

## “O” Model Basic Coupler

36" King Pin Location

Part No.	Dimension A	Trailer Width
2-0-365-36	94-1/4"	96"
2-0-365-36-1	100-1/4"	102"

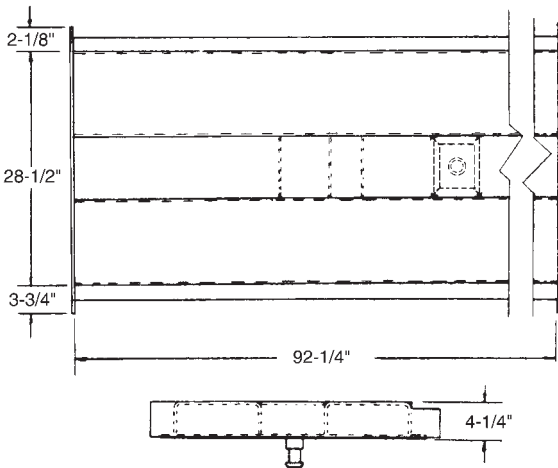

## “A” & “D” Model Rear Section 2-A51-86A-1

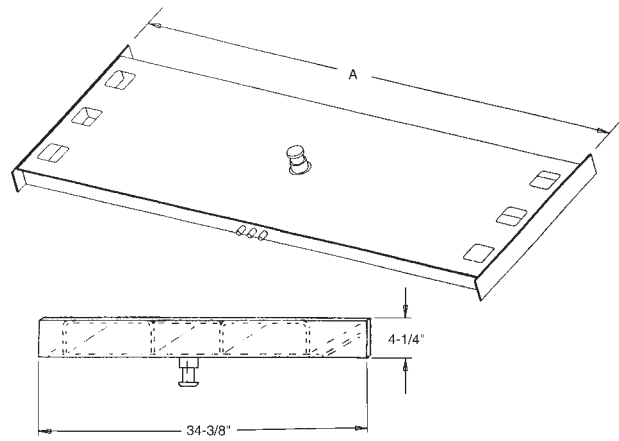

Fits most makes  
of trailers

## Universal Coupler Assemblies

Part No.	Dimension A	Trailer Width
700-2-8	95-1/4"	96"
700-2-8-1	101-1/4"	102"

# King Pins



## 8" Round King Pin

700-2-1

Unpolished;  
Designed for 3/8"  
Bottom Plate



## Double Spool King Pin

700-2-2

Used with 1/4" and 5/16"  
Bottom Plates



## Fruehauf Style King Pin

700-2-4

Used with 1/4" and 5/16"  
Bottom Plates

## Trailmobile Rectangular King Pins

2-52-40

For 1/4" Bottom Plate

2-52-41A

For 3/8" Bottom Plate

2-52-42A

For 5/16" Bottom Plate



# King Pin Locks



700-99-206

Call For Key Numbers



700-99-362

Call for Key Numbers

700-99-14-100

700-99-14-101

700-99-14-105

700-99-14-107

700-99-14-111

700-99-14-123

700-99-14-124

700-99-14-155

Other Key Numbers Available



## Trailmobile Design Rear Hitch

Repair Parts for this Hitch

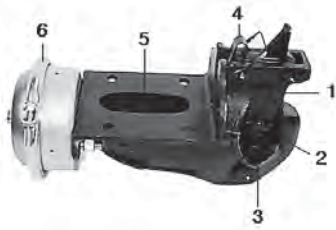

15-0-25

Item	Part No.	Description
1	15-7-10	Latch
2	15-A27-1	Plunger Spoon Assembly
3	15-8-16	Pin Spoon, 3/4" x 3-5/8"
4	15-3-9	Spring Latch
5	15-8-15	Extension - Chamber Rod
6	17-37-36	Air Chamber



**Trailmobile Standard  
Pintle Hook  
Crossmember**  
700-16-1



**Holland Pintle Hook**  
HL-PH200-1  
90,000 lb Maximum G.T.W.



**Plunger &  
Air Chamber  
for PH200-1**  
HL-XA-10198

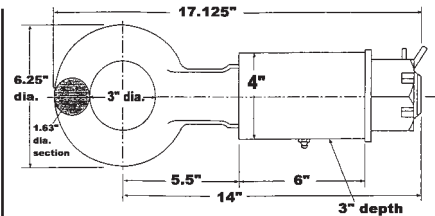

**Drawbar Eye**  
HL-DB-610-30  
3" I.D.

## Drawbar Eyes



20-1-22  
2-3/8" I.D.



20-1-28  
2-3/8" I.D.



20-1-26  
2-3/8" I.D.



**Drawbar Bolt**  
15-8-10

# Miscellaneous



- Quick and Easy to Apply
- No Mess, No Drip, No Waste
- Slik-Pak is a heavy duty grease compounded with molybdenum disulfide and graphite, sealed in a thin walled plastic envelope. Simply place the envelope on the fifth wheel base plate to apply - then hook up the trailer.

700-99-304

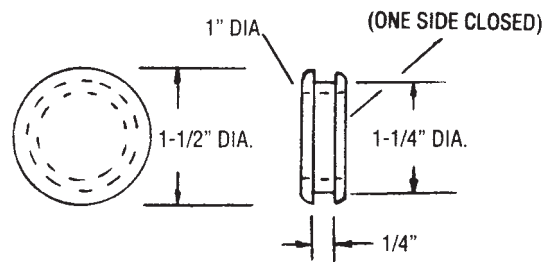

**Fifth Wheel Grommet**  
50-14-125



**Fifth Wheel Slick Disk  
with Ring**  
BP-SD-003



**Replacement  
Slick Disk Ring**  
BP-SD-002



**King Pin Gauge**  
HL-TF-0110

<b>FRONTS – NOSE RAILS &amp; CORNER CAPS</b> .....	<b>7-1 TO 7-5</b>
<b>FRONTS – RADIUS PANELS</b> .....	<b>7-6 TO 7-11</b>
<b>FRONTS – NOSE POSTS</b> .....	<b>7-12</b>
<b>SIDES – TOP RAILS</b> .....	<b>7-13 TO 7-16</b>
<b>SIDES – BOTTOM RAILS</b> .....	<b>7-17 TO 7-20</b>
<b>SIDES – SIDE POSTS</b> .....	<b>7-21 TO 7-26</b>
<b>SIDES – SIDE PANELS</b> .....	<b>7-26 TO 7-31</b>
<b>SIDES – LINER PANELS</b> .....	<b>7-32 TO 7-33</b>
<b>SIDES – SCUFF LINERS</b> .....	<b>7-34 TO 7-35</b>
<b>ROOFS – ROOF BOWS</b> .....	<b>7-36 TO 7-38</b>
<b>ROOFS – TARP BOWS</b> .....	<b>7-39</b>
<b>ROOFS – ROOF SHEETS &amp; REINFORCEMENTS</b> .....	<b>7-40</b>
<b>MORGAN TRUCK BODY</b> .....	<b>7-41 TO 7-46</b>
<b>UNDER FRAME – CROSSMEMBERS</b> .....	<b>7-47 TO 7-48</b>
<b>UNDER FRAME – CLIPS &amp; RAIL KITS</b> .....	<b>7-49</b>
<b>UNDER FRAME – FLOORS</b> .....	<b>7-50 TO 7-56</b>
<b>REAR FRAME – TOP HEADERS</b> .....	<b>7-57</b>
<b>REAR FRAME – CORNER POSTS</b> .....	<b>7-58</b>
<b>REAR FRAME – BOLSTERS &amp; BUMPERS</b> .....	<b>7-59 TO 7-60</b>
<b>REAR FRAME – TRAILMOBILE LIGHT MOUNTING BRACKETS</b> .....	<b>7-61</b>
<b>VENTS</b> .....	<b>7-62</b>
<b>MISCELLANEOUS</b> .....	<b>7-63</b>

## TRAILMOBILE NOSE RAILS

### "O" Model Bevel Corner

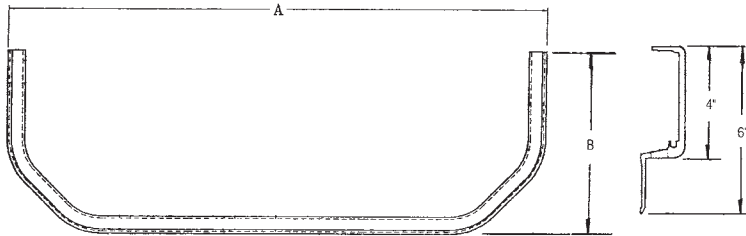

Part No.	A	B
511-1-109-2	96"	16-3/4"
511-1-109-2-1	102"	
511-1-109-2-2	102-3/8"	

### "O" Model 6" Radius

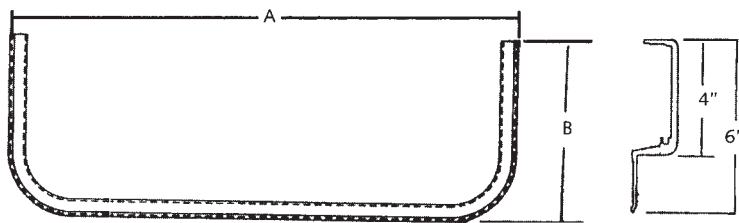

Part No.	A	B
511-1-130A	96"	16-1/2"
511-1-130B	102-3/8"	

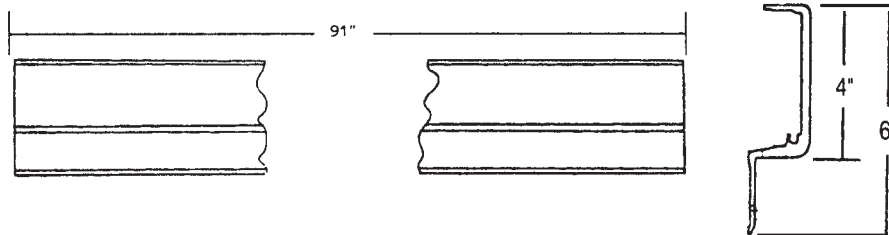

### Nose Rail Section

90-4-1978-0-93

### Nose Rail Reinforcement

90-4-2133-0-76

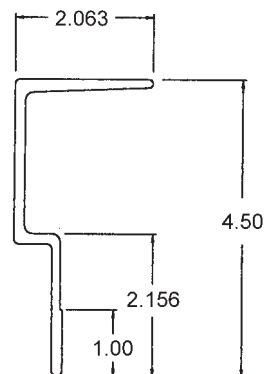



# Fronts - Nose Rails & Corner Caps

## TRAILMOBILE BOTTOM NOSE RAILS

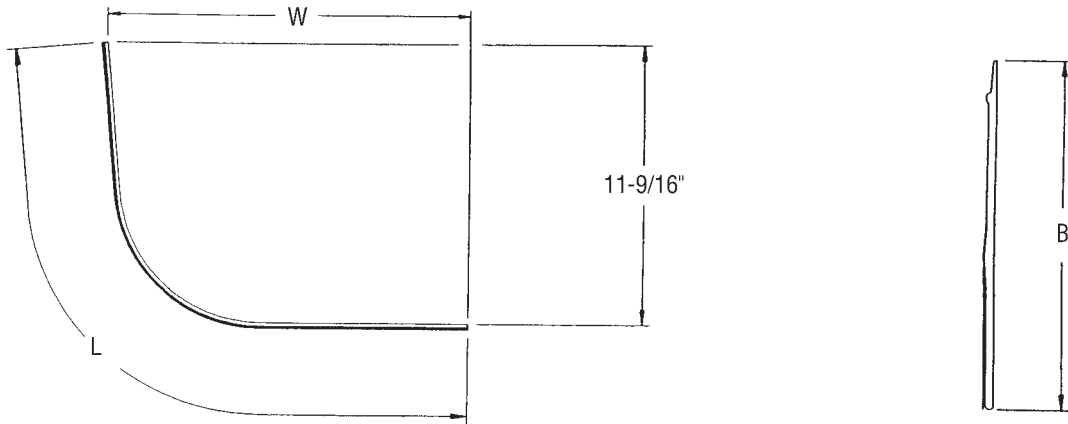

Part No.	Description	B	L	W
511-1-137L-B-A	Corner Rail, Roadside	8"	23-13/16"	15"
511-1-137R-B-A	Corner Rail, Curbside			
511-1-137L-B-B	Corner Rail, Roadside	9-15/16"		
511-1-137R-B-B	Corner Rail, Curbside			

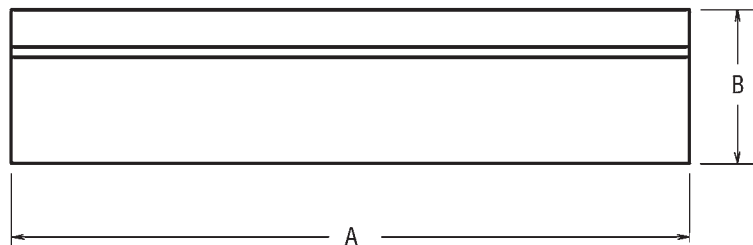

Part No.	Description	B	A
90-4-2313-0-88	Front Rail	8"	73"
90-4-2313-0-73		9-15/16"	

## Fruehauf "FB+" Nose Rails

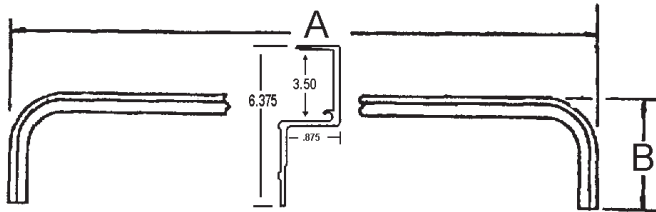

Part No.	Replaces	A	B
FR-NR03	WCF-3061-2	96"	15"
FR-NR04	WCF-3959-1	102"	

## Fruehauf "Double Step" Nose Rail

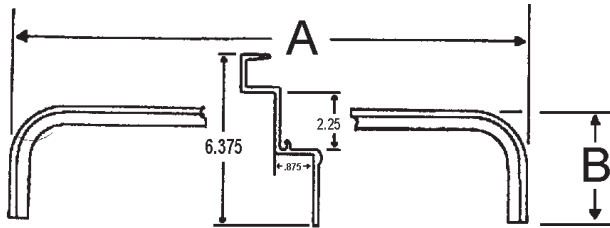

Part No.	Replaces	A	B
FR-NR05	WCF-5903-1	102"	13"

## Great Dane Nose Rail

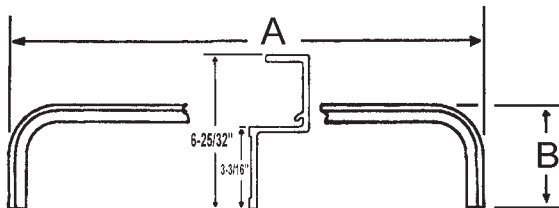

Part No.	Replaces	A	B
GD-NR03	69103212	102-3/8"	17-3/4"

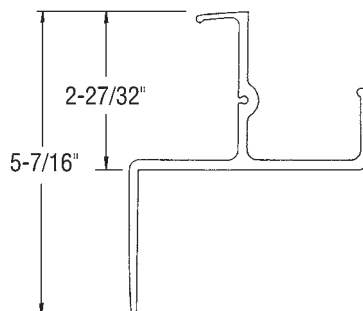

## Utility Nose Rail

Part No.	Replaces	Length
UT-NR01	1-6650-0046	97"

# Fronts - Nose Rails & Corner Caps



## TRAILMOBILE CORNER CAPS

### Plate Trailer

Part No.	Radius	Note
1511-A16-32	3"	Roadside
1511-A16-31		Curbside
1511-A16-30	6"	Roadside
1511-A16-29		Curbside

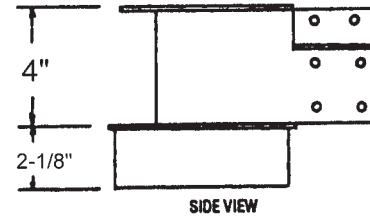

### AddVantage Trailer

Part No.	Note
9511-A1-24L	Roadside
9511-A1-24R	Curbside



### 2005 Model

Part No.	Note
7511-A1-05	Universal

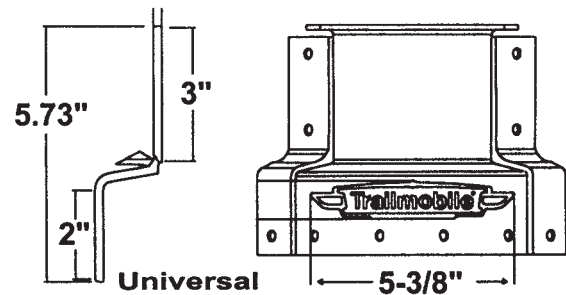

### 2005 Model Ultra Plate

Part No.	Note
7511-A1-06L	Roadside
7511-A1-06R	Curbside

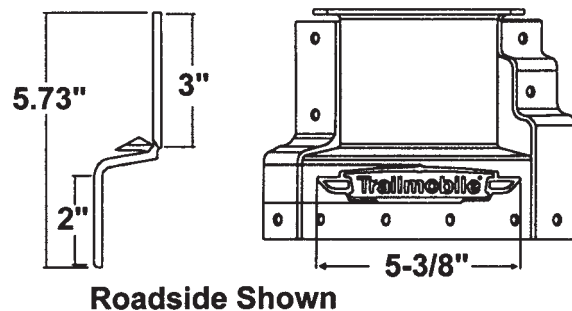

## REPLACEMENT CORNER CAPS



**Monon Curbside**  
HP-CC01  
Replaces V02-197R



**Monon Roadside**  
HP-CC02  
Replaces V02-198L



**Pines Universal**  
PI-CC01  
Replaces CC11100

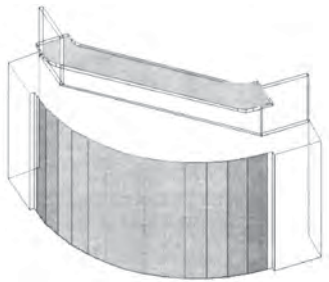

**Lufkin Universal**  
**10" Radius**  
LU-CC01  
Replaces 60113



**Lufkin Universal**  
**6" Radius**  
LU-CC02  
Replaces 65278



**Stoughton Universal**  
SO-CC01  
Replaces 04-1283500000



**Strick Curbside**  
S T-CC01  
Replaces AA65D002302



**Strick Roadside**  
S T-CC02  
Replaces AA65D002402



**Strick Universal**  
S T-CC03  
Replaces AA65D0028

# Fronts - Radius Panels



## TRAILMOBILE BEVEL CORNER RADIUS PANELS

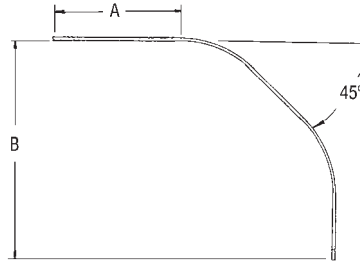

Part No.	Material	Color (* = PVC Coated)	Height	A	B
RP-881K-PPW	.050 Aluminum	White *	113"	6-7/8"	15-7/16"
RP-881X-PPW			86"		
RP-881-PPW	.063 Aluminum	Mill Finish	109"		
RP-881-MFA					
RP-881-SST	.035 Stainless Steel	Type 301 Bright *			

## TRAILMOBILE 6" RADIUS PANELS

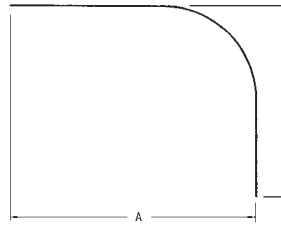

Part No.	Material	Color (* = PVC Coated)	Height	A	B
RP-883K-PPW	.050 Aluminum	White *	109"	15-5/8"	15-7/16"
RP-102K-PPW			115"	16-1/16"	11-1/4"
RP-958K-PPW			117-1/2"	15-7/16"	11-1/2"
RP-130-PPG		ABF Gray *	108"	16-1/16"	7-5/8"
RP-888-SST	.035 Stainless Steel	Type 301 Bright *	102"	12"	15-7/16"
RP-102-SST			111"	16-1/16"	11-1/4"
RP-958-SST			111-1/2"	15-7/16"	11-1/2"

## TRAILMOBILE "A" & "D" MODEL RADIUS PANEL

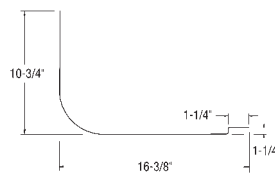

Part No.	Material	Color	Height	Radius
RP-444-MFA	.063 Aluminum	Mill Finish	114-25/32"	10"

## TRAILMOBILE PLATE TRAILER 3" RADIUS PANEL

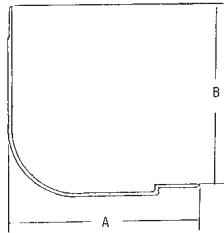

Part No.	Material	Color	Height	A	B
RP-2038-MFA	6061-T6 Aluminum	Mill Finish	110"	7-29/32"	7-29/32"

## TRAILMOBILE ADVANTAGE TRAILER 3" RADIUS PANEL

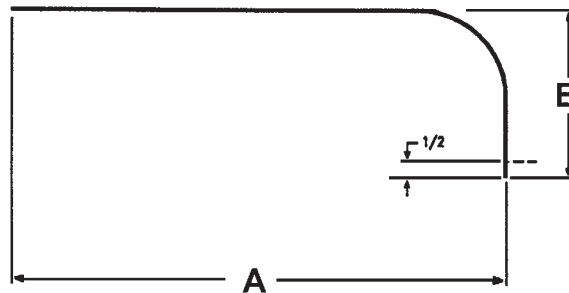

Part No.	Material	Color (* = PVC Coated)	Height	A	B
RP-1011K-PPW	.050 Aluminum	White *	116-1/8"	15-7/16"	5-3/8"

## TRAILMOBILE 2005 MODEL RADIUS CORNER

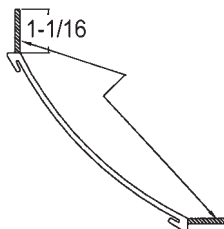

Part No.	Material	Color	Height
RP-115-MFA	6061-T6 Aluminum	Mill Finish	116-5/8"

## TRAILMOBILE 2005 MODEL RADIUS CORNER INSERT

RP-205-SST

Stainless Steel

# Fronts - Radius Panels

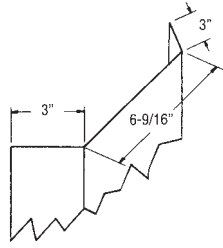

**Trailmobile  
Dry Freight  
Inner Radius**  
9519-1-507-E9  
18 Ga. Galvanized Steel  
Height = 108-1/8"

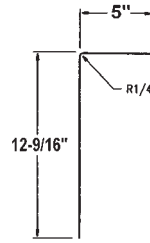

**Trailmobile  
Dry Freight  
Inner Radius**  
(For Standard 6" Radius)  
9519-1-909  
18 Ga. Galvanized Steel  
Height = 106-3/4"

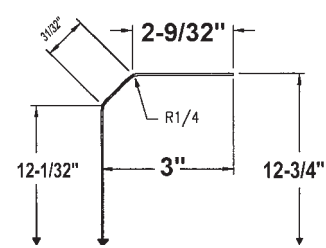

**Trailmobile  
Dry Freight  
Inner Radius**  
(For 6" Radius with  
100" Inside Width)  
6519-1-100-1166  
18 Ga. Galvanized Steel  
Height = 106"

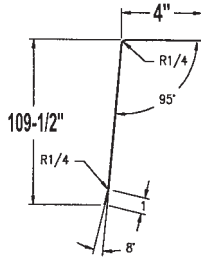

**Trailmobile  
AddVantage Trailer  
Inner Radius**  
(For 6" Radius)  
519-1-1724-1196-4  
18 Ga. Galvanized Steel  
Height = 109-1/2"

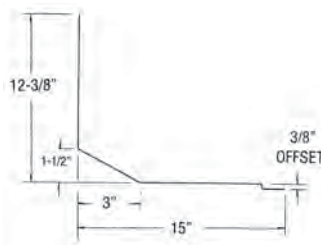

**Trailmobile  
"A" & "D" Model  
Inner Radius**  
700-519-1  
22 Ga. Galvanized Steel  
Height 102-1/8"

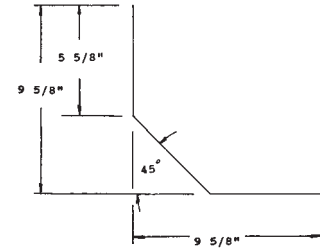

**Trailmobile  
F.R.P.  
Inner Radius**  
9513-1-1458A  
18 Ga. Galvanized Steel  
Height = 102-1/8"

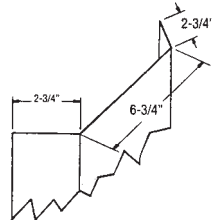

**Trailmobile  
"O" Model Reefer  
Inner Radius**  
508-20-29-31  
.060 PPW Aluminum  
Height = 105-1/4"

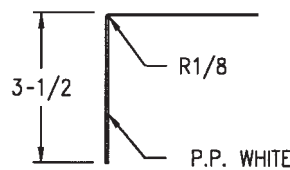

**Trailmobile  
Reefer  
Inner Radius**  
(For Standard 6" Radius)  
508-15-216-22  
.050 PPW Aluminum  
Height = 105-7/8"

## FRUEHAUF RADIUS PANELS

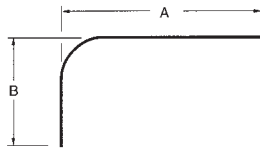

Part No.	Radius	Material	Color (PVC Coated)	Height	A	B	Replaces
FR-RP03	10"	.050 Aluminum	Gray	110"	40"	13"	WCC8051SPA
FR-RP04			White				WCC8051SPW
FR-RP05	5"				44"		WCF009212

## GREAT DANE RADIUS PANELS

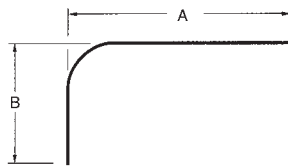

Part No.	Radius	Material	Color (PVC Coated)	Height	A	B	Replaces
GD-RP02	10"	.050 Aluminum	White	110"	39"	14"	14048
GD-RP01	6"			114"	34-1/4"	18"	00600W

## WABASH 10" RADIUS PANEL

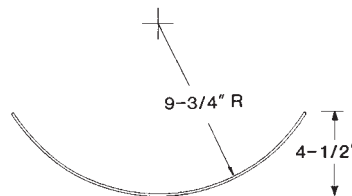

Part No.	Material	Color (PVC Coated)	Height	Replaces
WA-RP01	.050 Aluminum	White	110"	04A00011

## WABASH 5" RADIUS PANEL

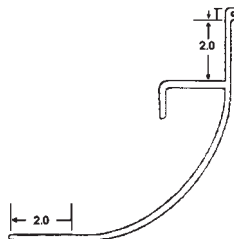

Part No.	Material	Color	Height	Replaces
WA-RP02	Extruded Aluminum	Bare	118-1/2"	E0081200



# Fronts - Radius Panels



## DORSEY RADIUS PANELS

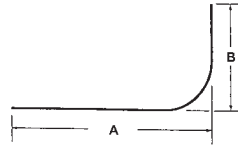

Part No.	Radius	Material	Color (PVC Coated)	Height	A	B	Replaces
DO-RP01	10"	.050 Aluminum	White	109"	31-13/16"	11-3/8"	FA30382
DO-RP03			Averitt Gray				
DO-RP02	6"		White	104"	27-3/8"		FA30783
DO-RP04			Averitt Gray				FB30783

## MONON RADIUS PANEL

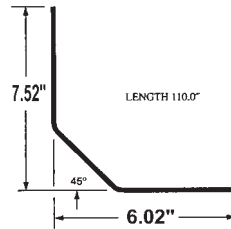

Part No.	Material	Color (PVC Coated)	Height	Replaces
HP-RP01	.050 Aluminum	White	110"	EC033532

## STOUGHTON RADIUS PANEL

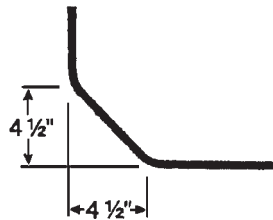

Part No.	Material	Color (PVC Coated)	Height	Replaces
SO-RP02	.063 Aluminum	White	107"	01-12994-XXX-00

## STRICK 7" RADIUS PANELS

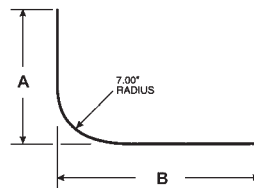

Part No.	Material	Color (PVC Coated)	Height	A	B	Replaces
ST-RP01	.050 Aluminum	White	105-1/2"	10-31/32"	13-1/2"	6876
ST-RP02			114-1/2"	8-1/8"	13-9/16"	EA63C30032503
ST-RP03			112-1/2"		9-1/16"	EA63C30013203

## STRICK BEVELED RADIUS PANEL

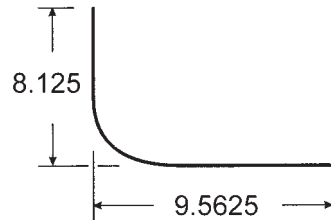

Part No.	Material	Color (PVC Coated)	Height	Replaces
ST-RP04	.050 Aluminum	White	105-1/2"	AA63C7236-2523

## STRICK BEVELED CORNER LINER

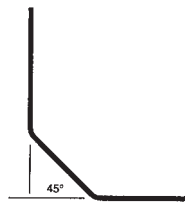

Part No.	Material	Color (PVC Coated)	Height	Replaces
ST-RP05	.048 Galavan	White	105-1/4"	06539
ST-RP06				06782
ST-RP07				45309

## UTILITY RADIUS CORNER

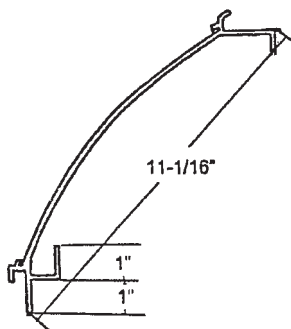

Part No.	Material	Color	Height	Replaces
UT-RP01	Extruded Aluminum	White	116-3/8"	1-6500-087

## UTILITY RADIUS CORNER INSERT

**UT-RP02**

Stainless Steel  
Replaces 03-2500-064

# Fronts - Nose Posts



## TRAILMOBILE NOSE POSTS

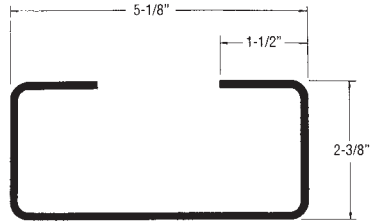

**10 Ga. Steel x 106-1/4"**  
511-23-183-0-108

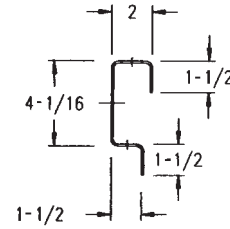

**12 Ga. Steel Reinforcement  
Channel x 106-5/8"**  
511-16-566-1166

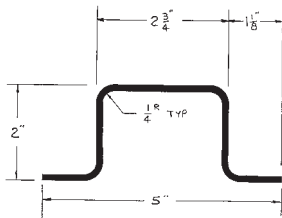

**12 Ga. Galvanized Steel  
Shoring Channel x 94"**  
700-90-124  
U.S. Postal Spec

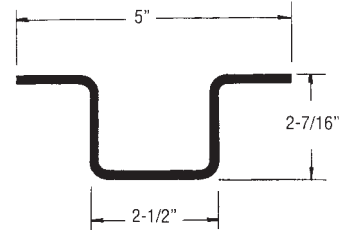

**14 Ga. Galvanized Steel  
x 117"**  
90-4-2400P-0-117

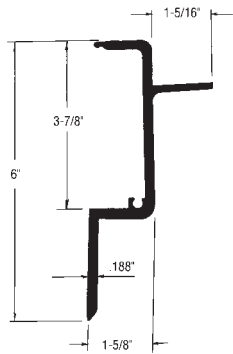

**Trailmobile Interior Post**

90-4-1399-240 20'-0"  
90-4-1399-625 52'-1"

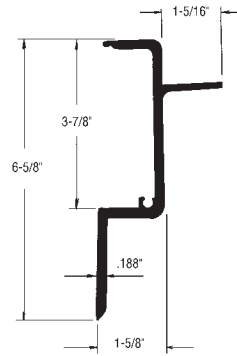

**Trailmobile Interior Post  
New Style**

90-4-2305-240 20'-0"  
90-4-2305-625 52'-1"

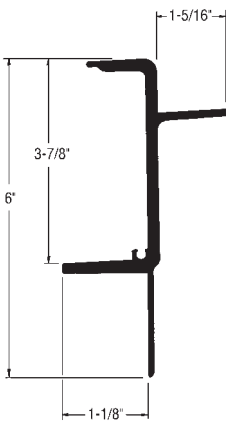

**Trailmobile Exterior Post**

90-4-1650-613 51'-1"

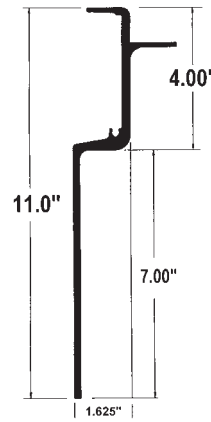

**Trailmobile Wedge**

90-4-2365-613 51'-1"

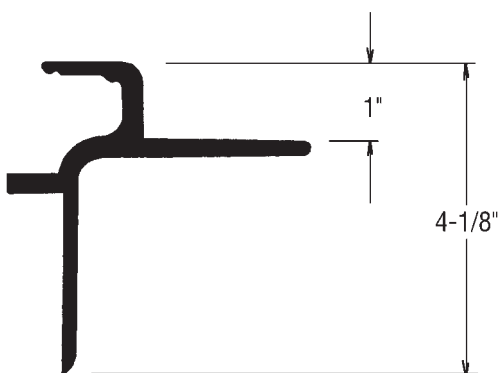

**Trailmobile Plate**

90-4-1992-624 52'-0"

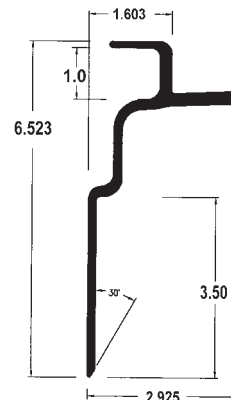

**Trailmobile Ultra-Plate**

90-4-2503-625 52'-1"

# Sides - Top Rails

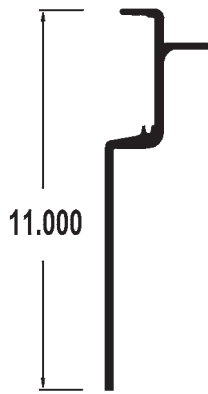

**ABF**

90-4-2519-312 26'-0"

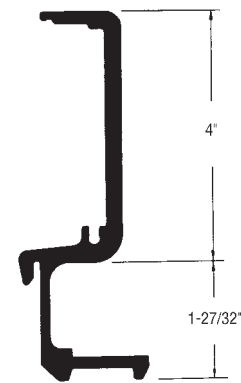

**Trailmobile**

**Meat Rail Reefer**

90-4-1568-620 51'-6"

## TRAILMOBILE REEFER 2-Piece

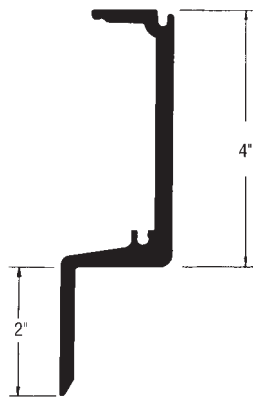

90-4-1571-613 51'-1"

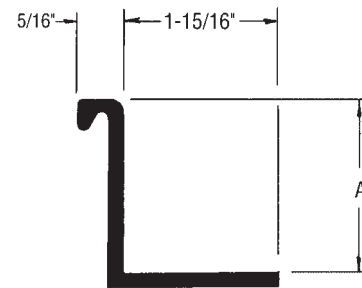

90-4-1906-547 45'-7"; A = 2"

## TRAILMOBILE REEFER 2-Piece New Style

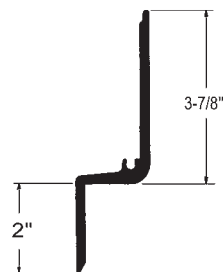

90-4-2314-613 51'-1"

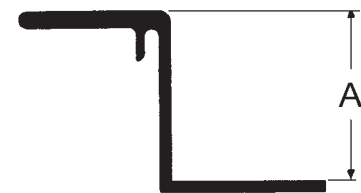

90-4-2396-618 51'-6"; A = 1"

90-4-2367-618 51'-6"; A = 1-1/2"

90-4-2315-617 51'-5"; A = 2"

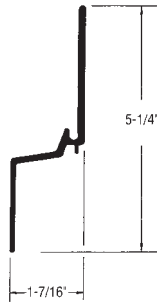

**Trailmobile Top Rail Splice  
Outside Application**  
90-4-1689-108 108"

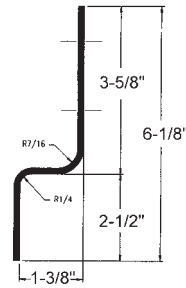

**Trailmobile Top Rail Splice  
Inside Application  
for 6" Radius**

6514-9-100 4-1/2"  
6514-9-100-0-72 72"

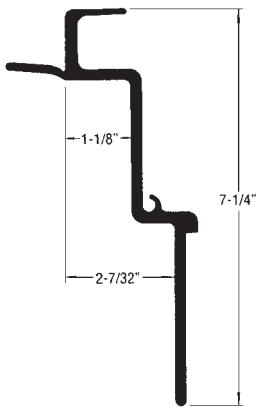

**Fruehauf Double Step**  
FR-TR04-624 52'-0"  
Replaces STK-021692

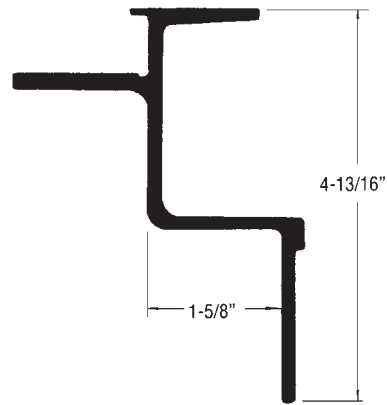

**Great Dane**  
GD-TR01-616 51'-4"  
Replaces 71035

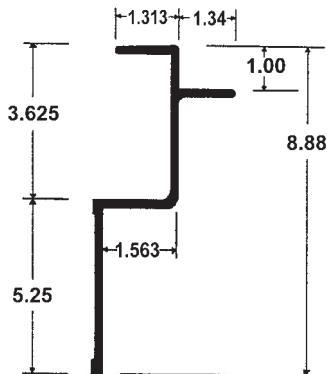

**Great Dane P-Series**  
GD-TR03-626 52'-2"  
Replaces AE1P0005205

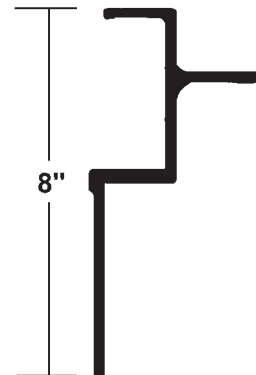

**Lufkin**  
LU-TR01-624 52'-0"  
Replaces 85948

# Sides - Top Rails

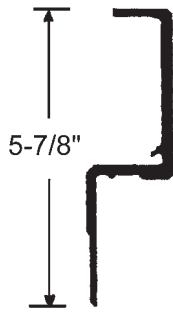

**Stoughton**  
**SO-TR01-621** 51'-9"  
 Replaces 09727

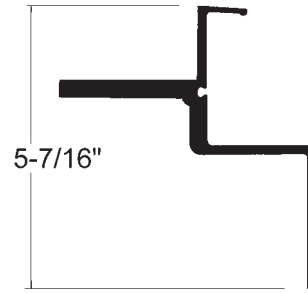

**Utility**  
**UT-TR02-628** 52'-4"  
 Part No. xxxxxxxxxx

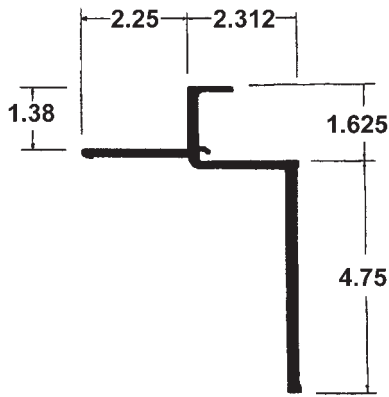

**Utility 3000R**  
**UT-TR03-625** 52'-1"  
 Replaces 1-6650-150

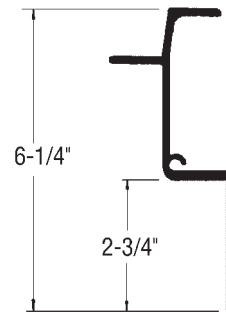

**Wabash Dry Freight**  
**WA-TR01-624** 52'-0"  
 Replaces FC#08100149

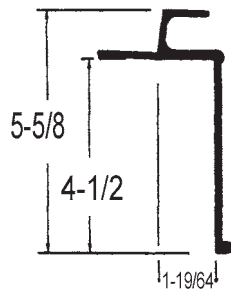

**Wabash Plate**  
**WA-TR03-626** 52'-2"  
 Replaces E0076260

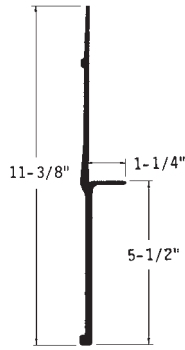

**Trailmobile**  
 90-4-2352-96 8'-0"  
 90-4-2352-240 20'-0"  
 90-4-2352-625 52'-1"

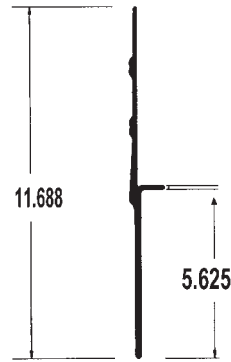

**Trailmobile**  
 90-4-2111-619 51'-7"

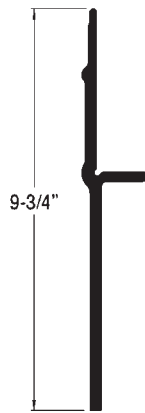

**Trailmobile**  
 90-4-2120-619 51'-7"

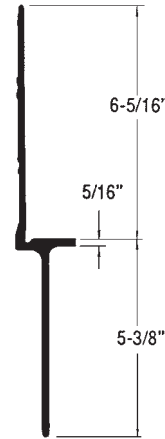

**Trailmobile**  
 90-4-1076-613 51'-1"

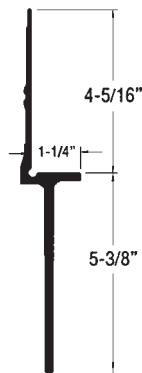

**Trailmobile**  
 90-4-1215-613 51'-1"

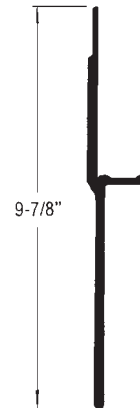

**Trailmobile**  
 90-4-2037-619 51'-7"



# Sides - Bottom Rails

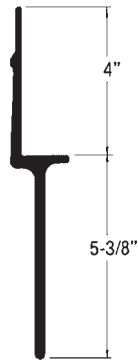

**Trailmobile "Fleet" Rail**  
90-4-1855-559 46'-7"

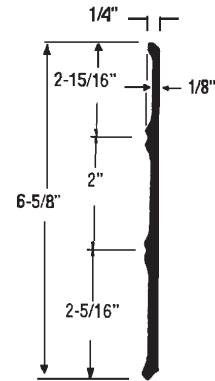

**Trailmobile  
FRP Reinforcement**  
90-4-1227-553 46'-1"

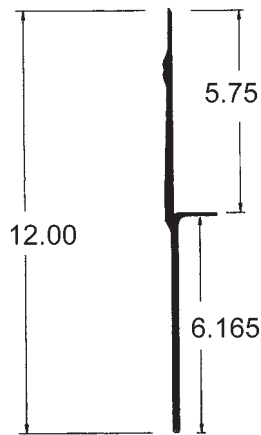

**Trailmobile Reefer**  
90-4-2079-619 51'-7"

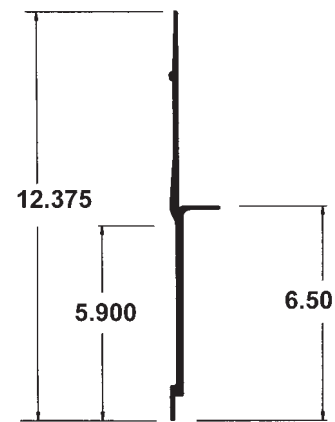

**Trailmobile Lightweight Reefer**  
90-4-2308-621 51'-9"

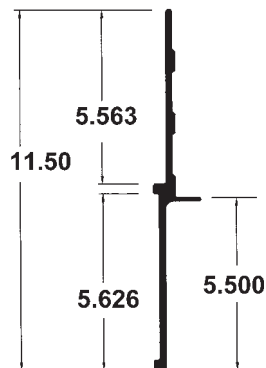

**Trailmobile Ultra-Plate**  
6090-4-1037-625 52'-1"

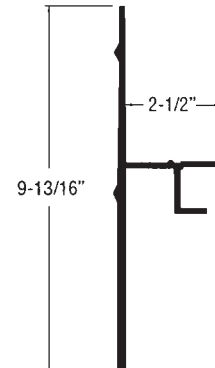

**Fruehauf FB+**  
FR-BR03-624 52'-0"  
Replaces STK-020963

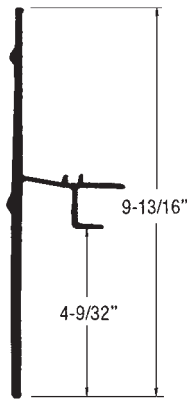

**Fruehauf**  
FR-BR01-625 52'-1"  
Replaces STK-021038

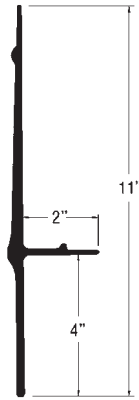

**Great Dane**  
GD-BR02-625 52'-1"  
Replaces 71025/27

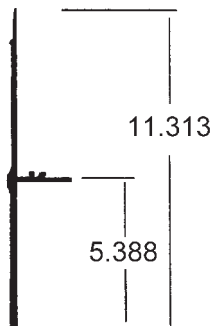

**Great Dane P-Series**  
GD-BR03-626 52'-2"  
Replaces AE2P0005210



**Stoughton**  
SO-BR01-621 51'-9"  
Replaces 09727

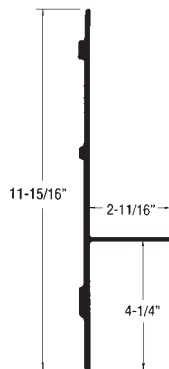

**Utility**  
UT-BR02-628 52'-4"  
Replaces 1-6650-062

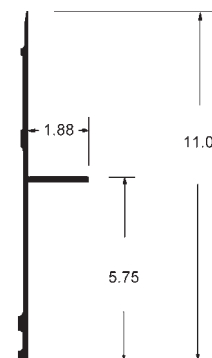

**Utility 3000R**  
UT-BR03-625 52'-1"  
Replaces 1-6650-149

# Sides - Bottom Rails



**Wabash Dry Freight**  
**WA-BR02-626** 52'-2"  
 Replaces FC#10100953

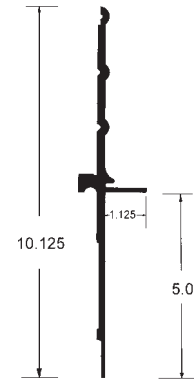

**Wabash Dura Plate**  
**WA-BR04-626** 52'-2"  
 Replaces E7326260

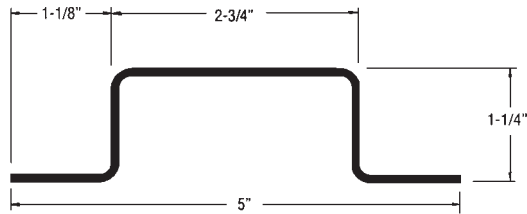

**Trailmobile  
"A" and "D" Model**  
90-4-983-0-123 123"  
14 Ga. Steel

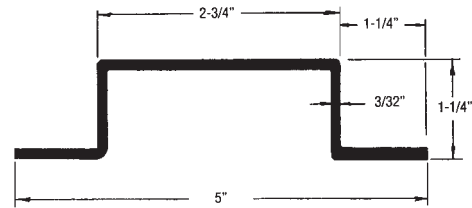

**Trailmobile  
"A" and "D" Model**  
90-4-483-0-114 114"  
Aluminum

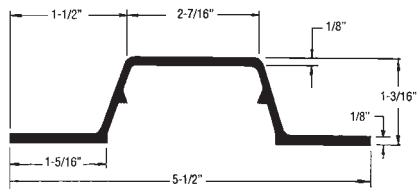

**Trailmobile "O" Model**  
90-4-1082-0-115 115"  
Aluminum

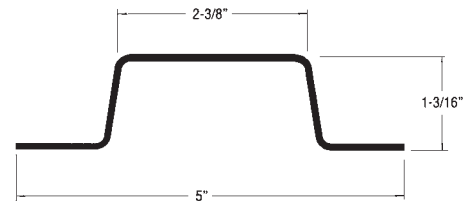

**Trailmobile**  
90-4-1988P-0-112 112"  
90-4-1988P-0-135 135"  
Both 16 Ga. Galv. Steel; Punched

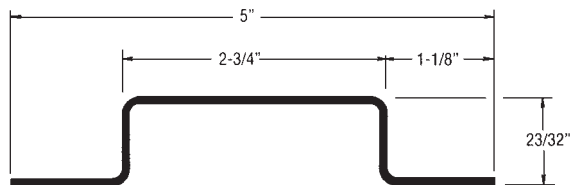

**Trailmobile**  
90-4-2033P-0-112 112"  
12 Ga. Galv. Steel; Punched

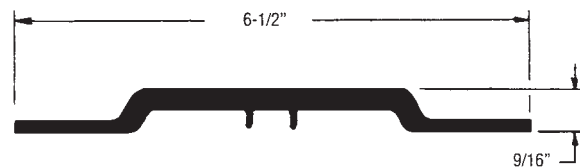

**Trailmobile Plate**  
90-4-1911-0-123 123"  
Aluminum

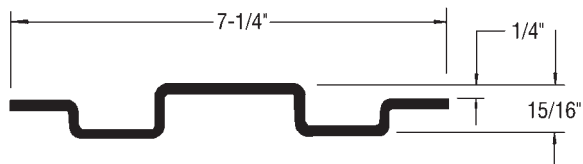

**Trailmobile "E" Slot**  
9513-5-1114-1166-E12 106-7/8"  
14 Ga. Galv. Steel

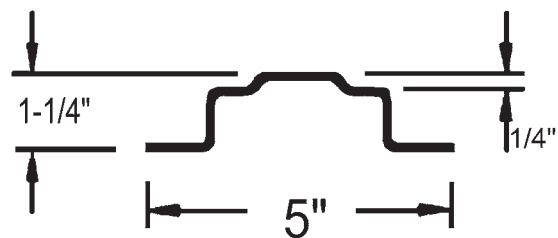

**Trailmobile "E" Slot**  
513-5-600-1166-E-12 106-7/8"  
14 Ga. Galv. Steel

# Sides - Side Posts

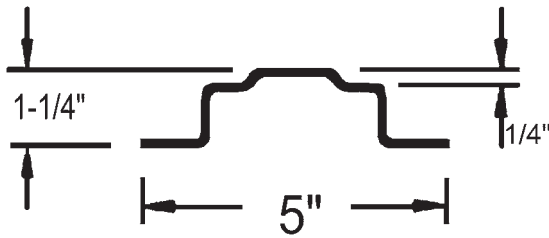

## Trailmobile "A" Slot

513-5-600-1250-A-12 115-1/4"  
14 Ga. Galv. Steel

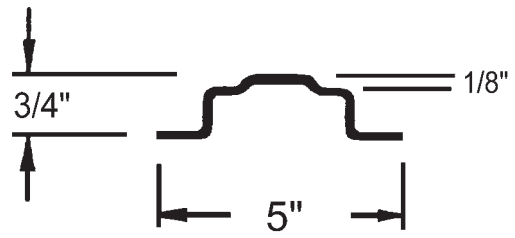

## Trailmobile "A" Slot

6513-5-108-1176-A-12 107-5/8"  
12 Ga. Galv. Steel

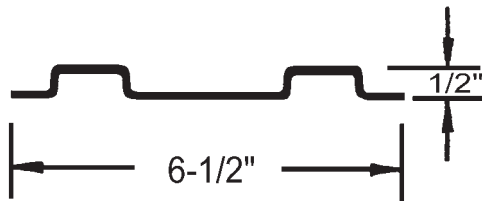

## Trailmobile AddVantage "A" Slot

513-5-686-1226-A 112-7/8"  
15 Ga. Galv. Steel

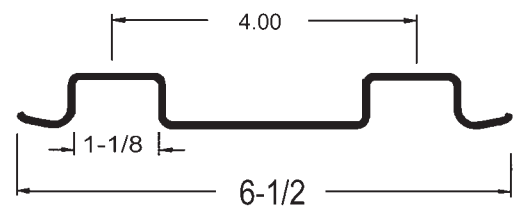

## Trailmobile AddVantage Carpet Hauler "A" Slot

6513-5-130-12 107-5/8"  
14 Ga. Galv. Steel; Punched

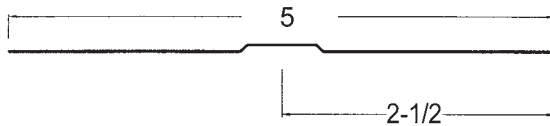

## Trailmobile Ultra Plate Outer Post

6513-5-151-1216 112-7/16"  
.019 Galv. Steel; PPW

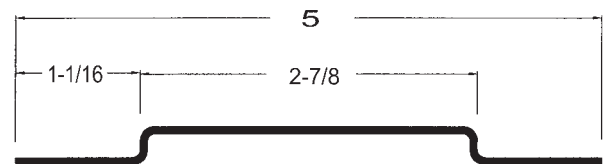

## Trailmobile Ultra Plate "A" Slot Inner Post

6513-5-152-1216 112-7/16"  
16 Ga. Galv. Steel

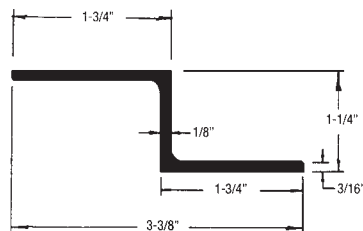

## Trailmobile "A" and "D" Model Reefer

90-4-646-0-115 115"  
Aluminum

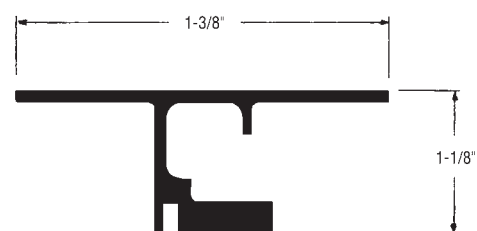

## Trailmobile Reefer

90-4-2381-0-112 112"  
Aluminum

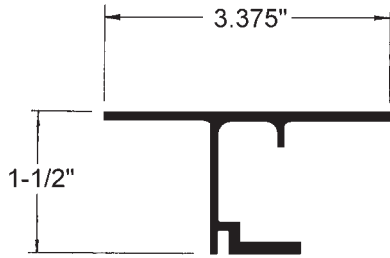

**Trailmobile Reeper**  
90-4-1892-0-115 115"  
Aluminum

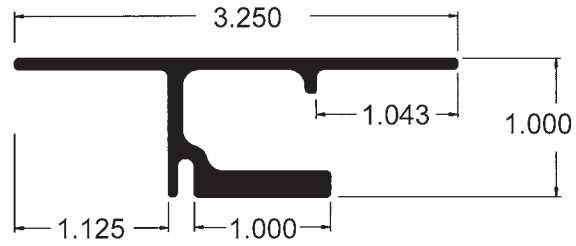

**Trailmobile Reeper**  
90-4-2412-0-113 113"  
Aluminum

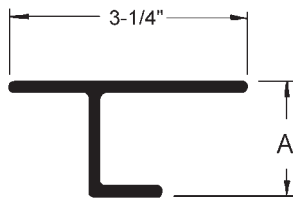

**Trailmobile Reeper**  
90-4-1838-0-115 115"; A = 1-1/2"  
90-4-1896-0-108 108"; A = 2"  
Composite

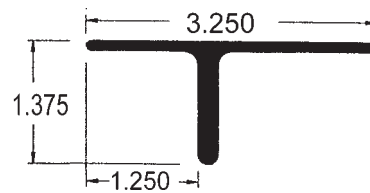

**Trailmobile Reeper**  
90-4-2317-0-115 115"  
Composite

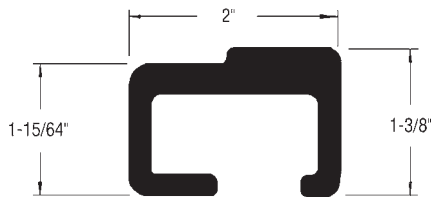

**Trailmobile Reeper  
Composite Post Reinforcement**  
90-4-2107-0-16 16"  
Composite

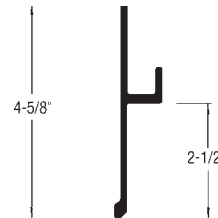

**Trailmobile Side Attachment  
"FRP"**  
90-4-2173-0-115 115"  
Aluminum

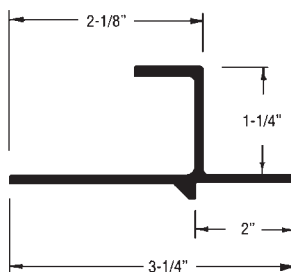

**Trailmobile Side Attachment**  
90-4-1081-0-108 108"  
Aluminum

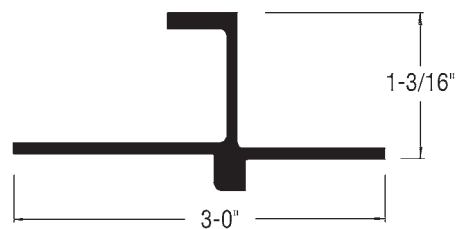

**Trailmobile Side Attachment**  
90-4-2349-0-121 121"  
Aluminum

# Sides - Side Posts

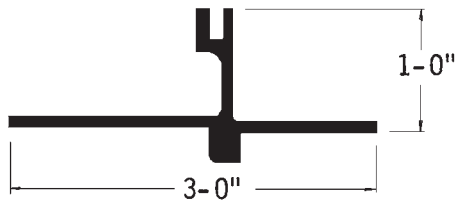

**Trailmobile Side Attachment**  
 90-4-2310-0-115 115"  
 Aluminum

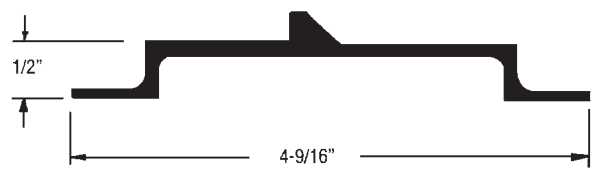

**Trailmobile Side Attachment**  
 90-4-1721-0-110 110"  
 Aluminum

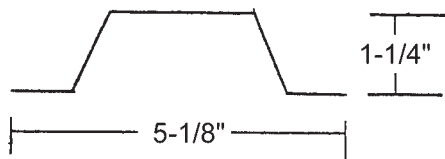

**Dorsey**  
 DO-SP01 112"  
 Steel; Replaces 1210513

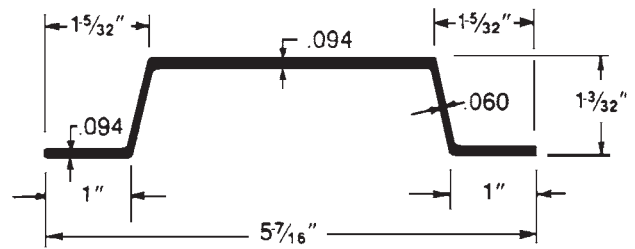

**Fruehauf**  
 FR-SP01 115"  
 Aluminum; Replaces STK-020522

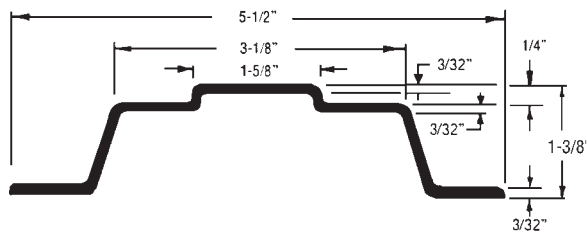

**Fruehauf**  
 FR-SP02 115"  
 Aluminum; Replaces STK-020564

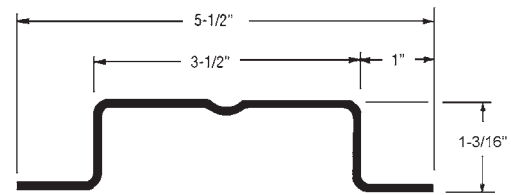

**Fruehauf**  
 FR-SP03 107-1/2"  
 18 Ga. Galv Steel; Replaces STK-030237

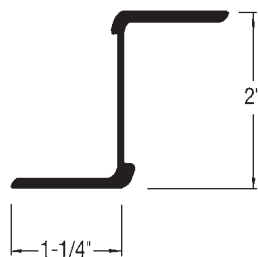

**Great Dane**  
 GD-SP01 115"  
 Aluminum; Replaces 70092

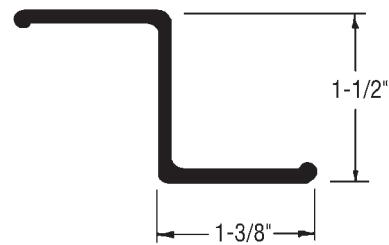

**Great Dane**  
 GD-SP02 107"  
 Aluminum; Replaces 75722

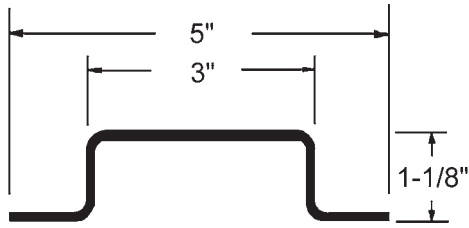

**Lufkin**  
**LU-SP01** 110"  
Steel; Replaces 86538

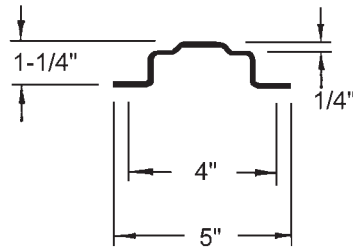

**Lufkin "E" Slot**  
**LU-SP03P** 115-1/4"  
Steel; Punched; Replaces 7087476

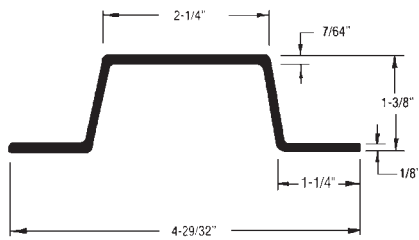

**Gindy**  
**90-4-920-0-110** 110"  
Aluminum; Replaces GB-5

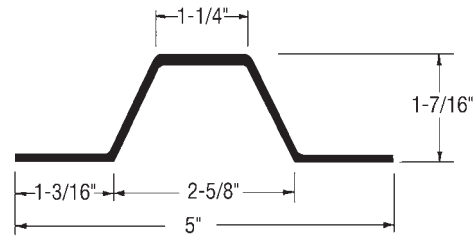

**Gindy-Strick**  
**90-4-921-0-110** 110"  
Aluminum; Replaces GB-6

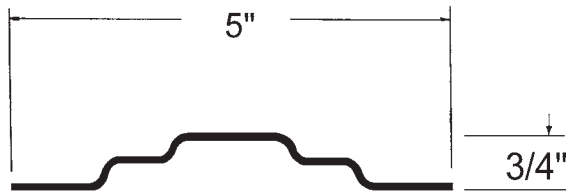

**Strick "A" Slot**  
**ST-SP01** 107-3/8"  
Steel; Replaces 46230

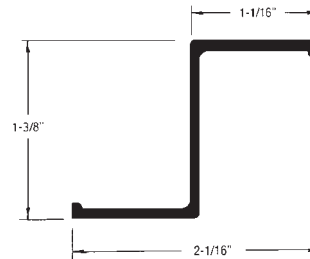

**Utility**  
**UT-SP01** 115"  
Aluminum; Replaces 1-6500-035

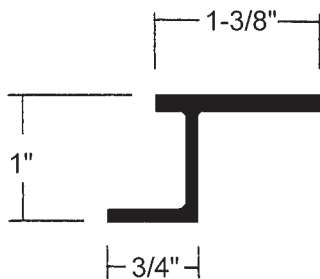

**Utility**  
**UT-SP02** 115"  
Aluminum; Replaces 1-6500-110



**Wabash Plate**  
**WA-SP01** 125-1/4"  
Aluminum; Replaces FC# 01100841



# Sides - Side Posts

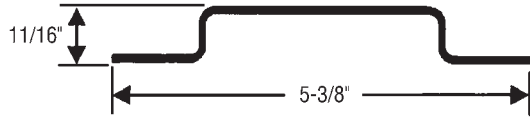

**Wabash**  
**WA-SP03** 111-1/2"  
 Galv. Steel; Replaces FC# 01101038

# Sides - Side Panels

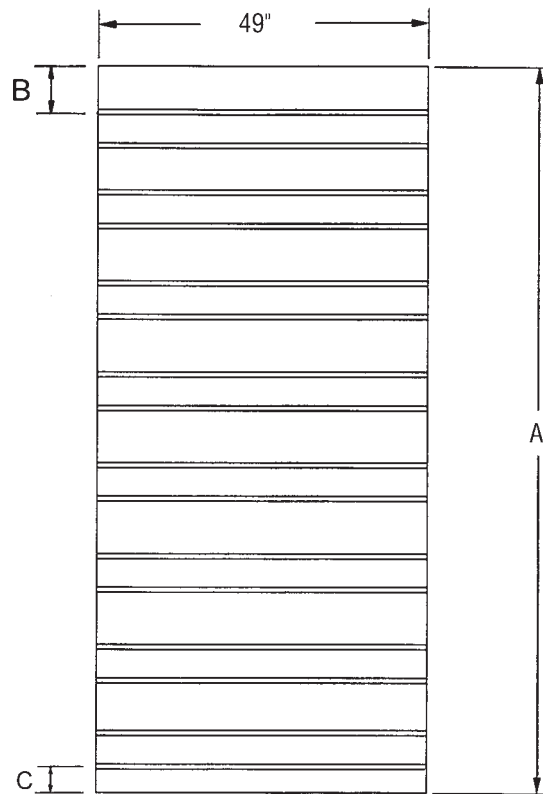

## Trailmobile Corrugated 4" & 8" Centers

Part No.	Material	Color (PVC Coated)	No. of Corrugations	A	B	C
700-513-27-26	.050 Aluminum	White	16	107-1/2"	15"	4-1/2"
700-513-18-26			17	115-1/2"	16"	3-1/2"

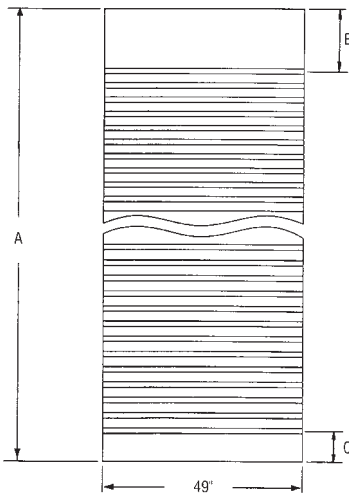

## Trailmobile Corrugated 2" Centers

Part No.	Material	Color (PVC Coated)	No. of Corrugations	A	B	C
392-752-62D-16	.040 Aluminum	White	47	97-1/4"	3-3/4"	1-1/2"
392-752-62C-16			48	105-1/2"	10-1/2"	
392-752-62A-16			49	109-1/2"	12"	
392-752-62H-16			50		10"	
392-752-62e-16			51	112-1/2"	11"	

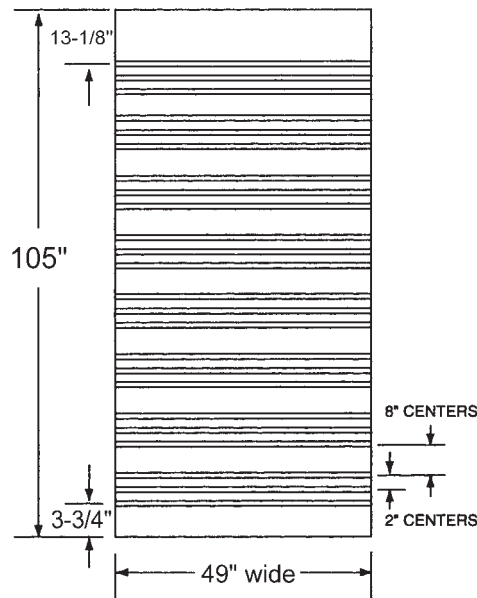

## Dorsey Corrugated

Part No.	Material	Color (PVC Coated)	No. of Corrugations
DO-SS01	.050 Aluminum	White	24

# Sides - Side Panels

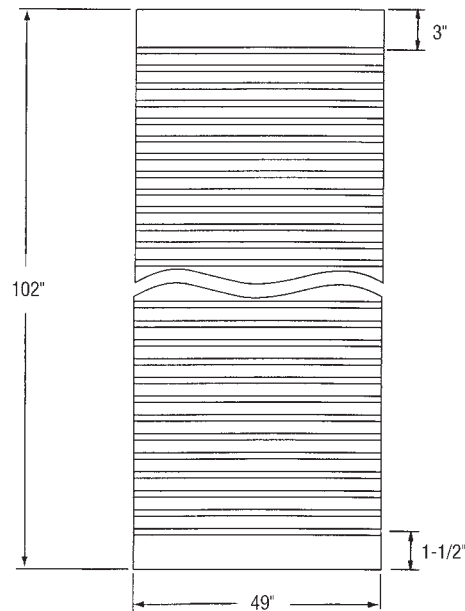

**Fruehauf Corrugated**  
1-1/2" Centers

Part No.	Material	Color (PVC Coated)	No. of Corrugations
FR-SS01	.050 Aluminum	White	66

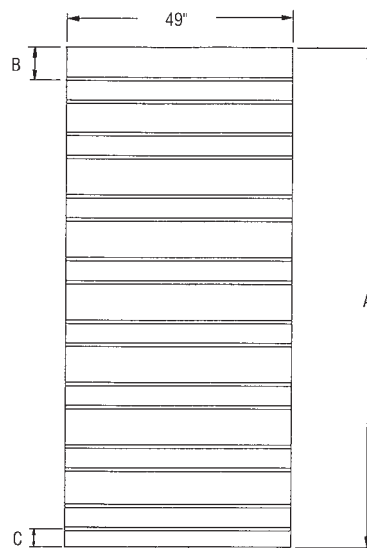

**Great Dane Corrugated**  
4" & 8" Centers

Part No.	Material	Color (PVC Coated)	No. of Corrugations	A	B	C
GD-SS01	.040 Aluminum	White	15	102"	11-1/2"	6-1/2"
GD-SS02			16	110-1/2"	16"	

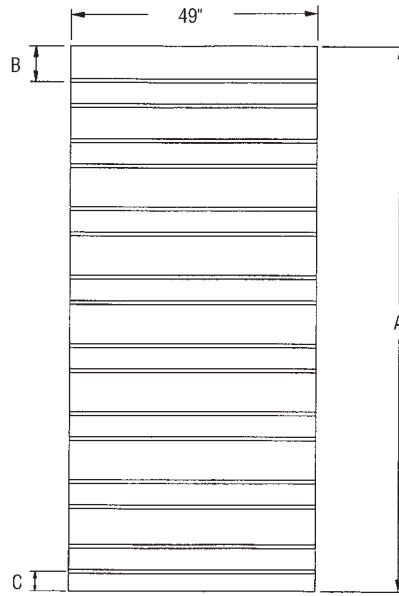

**Utility Corrugated**  
**4" & 8" Centers**

Part No.	Material	Color (PVC Coated)	No. of Corrugations	A	B	C
UT-SS01	.040 Aluminum	White	15	105-1/2"	16"	5-1/2"
UT-SS02			16	108"	14-1/2"	
UT-SS03			15	106"		7-1/2"

# Sides - Side Panels

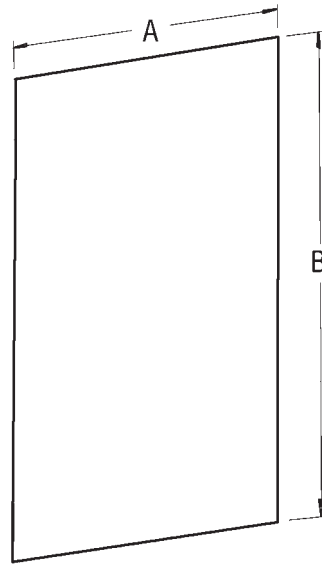

## Flat Sheets

Part No.	Material	Color ( * = PVC Coated)	A	B
700-513-10	.026 Galv. Steel	White/Galvanized	49"	110"
511-20-882A-0-F3-V	.035 Stainless Steel	Stainless Steel *	25"	110-1/2"
700-511-25				111"
1X040X49X110W-PVC	.040 Aluminum	White/Wash *	49"	110"
1X040X49X93W-PVC				93"
1X050X49X110PPAVG	.050 Aluminum	Averitt Gray/Wash		110"
1X050X49X110BARE		Bare/Bare		110"
1X050X49X123BARE				123"
1X050X49X110BLK-PVC		Black/Wash *		110"
1X050X49X110PCR-PVC		Coke Red/Wash *		110"
1X050X49X120UPS		UPS Gray/Bare		120"
1X050X49X115PPMB		Whirlpool Blue/Wash		115"
1X050X49X110PPW/G		White/Gray		110"
1X050X49X123PPW/G				123"
1X050X49X110PPW		White/Wash		110"
1X050X49X110PPW-50PC				110"
1X050X49X120PPW				120"
1X050X55X120PPW			55"	120"
1X050X49X110W-PVC		White/Wash *	49"	110"
1X050X49X120W-PVC	120"			
1X063X49X123BARE	.063 Aluminum	Bare/Bare		123"

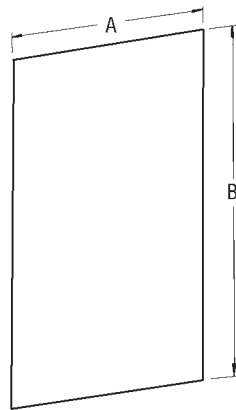

## Plate Panels

Part No.	Material	Color	A	B
700-513-29	.125 Aluminum	Bare/Bare	48"	115"
700-513-30-PPW		White/Bare		

## Ultra Plate Panel

Part No.	Material	Color	A	B
700-513-39	.236 Composite	White/White	45"	112-7/16"

## FRP Panels

Part No.	Material	Color	A	B
700-513-36	3/4" Core FRP	White	89-1/8"	108"

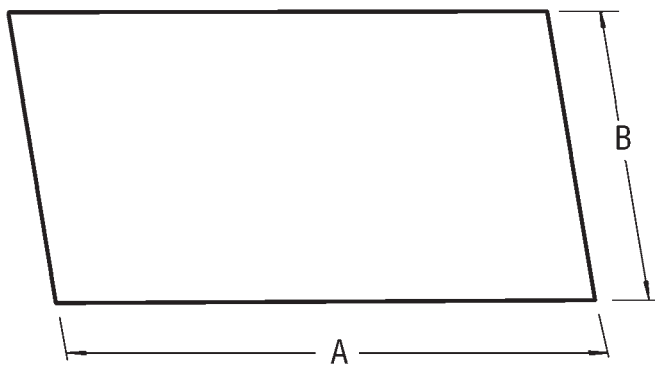

Part No.	Material	Color	A	B
7/8FRPX24	3/4" Core FRP	White	24'	29-1/4"

TYPICAL INSTALLATION

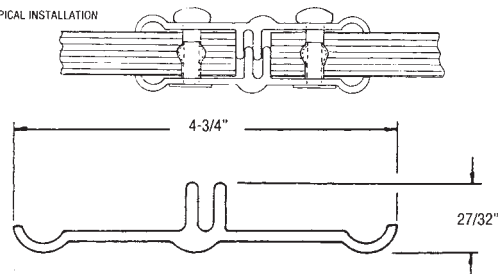

## FRP Joint Strip

- 90-4-1666-0-112 Length 9'-4"
- 90-4-1666-0-553 Length 46'-1"

# Sides - Liner Panels

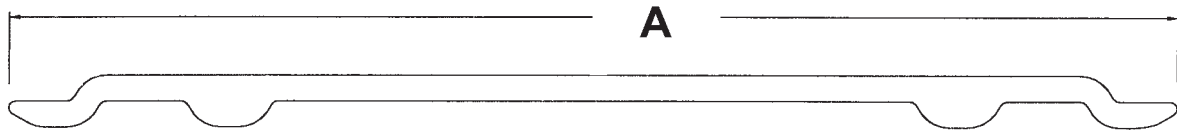

90-4-2468-0-108 shown

## AddVantage Snap-In Liners

Part No.	A	Length
90-4-2468-0-108	10-7/16"	108"
90-4-2495-0-108		
90-4-2494-0-108	6-1/8"	112-7/8"
90-4-2471-0-113		

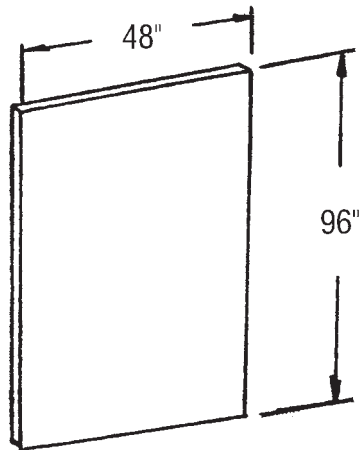

## Plywood Liner Panels

Part No.	Material	Thickness
700-519-6	BC Plywood	1/4"
700-519-9	Imported BC Plywood	5.5 mm
700-519-10	CDX Plywood	3/4"

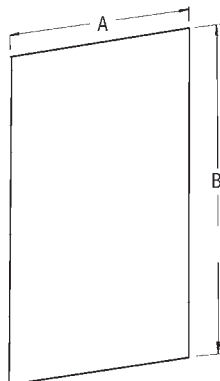

## Flat Fiberglass Liner Panels

Part No.	Thickness	A	B
120X48X96	.120	48"	96"
090X48X96	.090		108"
090X48X108			120"
090X48X120			

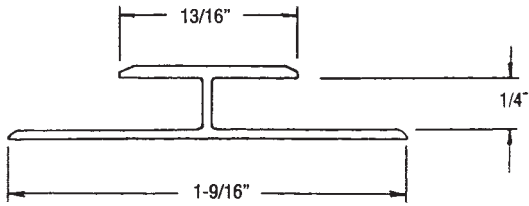

**Trailmobile  
Plywood Joint Strip**  
90-4-1390-0-108 108"  
Aluminum

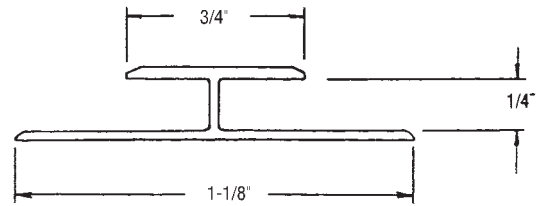

**Plywood Joint Strip**  
90-4-1903-0-156 156"  
Plastic

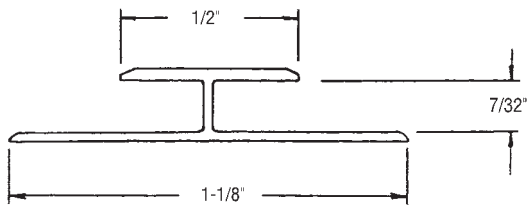

**Fiberglass Lining Joint Strip**  
90-4-1393-0-96 96"  
Plastic



### Fiberglass Scuff Liners

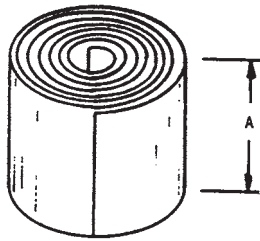

Part No.	A	Thickness	Length	
090X12X48	12"	.090	48'	
090X12X53			53'	
090X12X212			212'	
120X12X48		.120	48'	
120X12X53			53'	
090X16X48			16"	.090
090X16X53	53'			
120X16X53	.120	53'		
090X24X48	24"	.090	48'	
090X24X53			53'	
120X24X48			.120	48'
120X24X53		53'		
090X48X48		48"		.090
090X48X53			53'	
120X48X48	.120		48'	
120X48X53			53'	

### Fiberglass Wall Liners

Part No.	A	Thickness	Length
090X98X48	98"	.090	48'
090X98X53			53'
120X98X48		.120	48'
090X105X53	105"	.090	53'

### Synthetic Scuff Liners

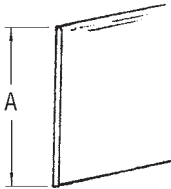

Part No.	A	Color	Length	Note	Thickness
700-523-20-8	12"	Black	8'	Flat	5/8"
700-523-20-28			28'		
700-523-20			52'	Rolled	
700-523-20R		Flat			
700-523-19		White		Rolled	
700-523-19R					
700-523-23R	18"	Black	Rolled		
700-523-22R		White			



### Steel Scuff Liners

Part No.	A	Length	Material
90-4-2480-622	10"	51'-10"	16 Ga. Galv.
90-4-1876-562	12-1/4"	46'-10"	
90-4-1876-624		52'-0"	
700-90-48	18-1/4"	47'-0"	
700-90-48-624		52'-0"	

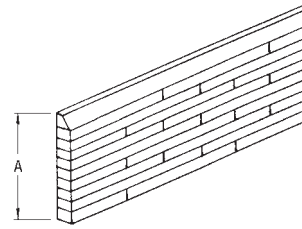

### Laminated Hardwood Scuff Liners

Part No.	A	Thickness	Length	Material
700-523-26	12"	3/4"	8'	Laminated Hardwood
700-523-8			47'	
700-523-24			52'	
700-523-27		1"	47'	

### Aluminum Scuff Liners

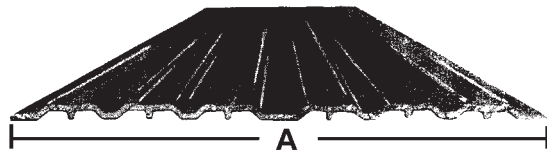

Part No.	A	Length	Material
90-4-996-562	12-5/16"	46'-10"	.094
90-4-996-626		52'-2"	Aluminum

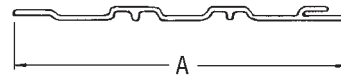

Part No.	A	Length	Material
90-4-1707-626	8-1/2"	52'-2"	.094 Aluminum

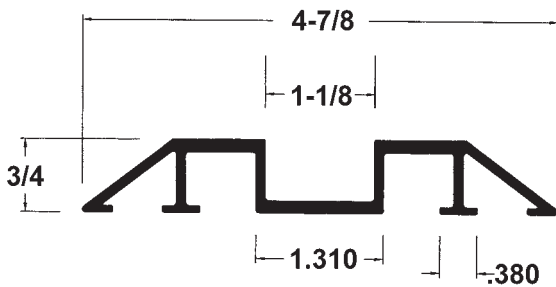

**Aluminum Rub Rail**  
90-4-2406-621 51'-9"

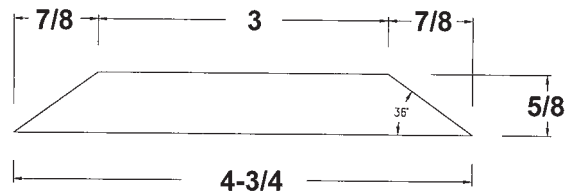

**Aluminum Rub Rail End Cap**  
9519-11-1558

# Roofs - Roof Bows

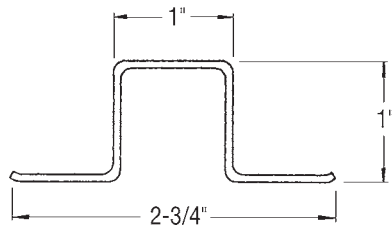

## Trailmobile Cambered Hat

9514-3-78B 99-1/8"  
Galvanized Steel

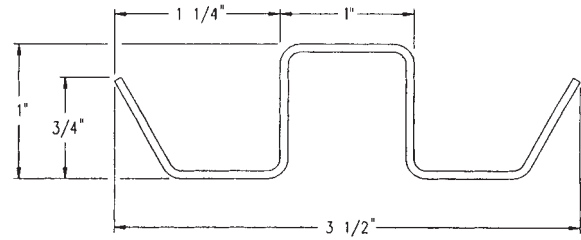

## Trailmobile Cambered Anti-Snag

514-3-152B 99-1/8"  
Galvanized Steel

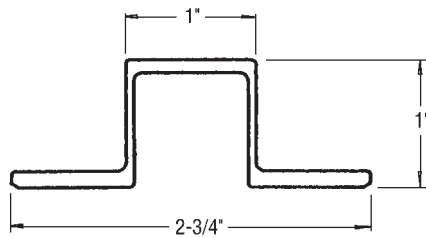

## Trailmobile Cambered Hat

514-3-145A-2 99-1/8"  
Aluminum

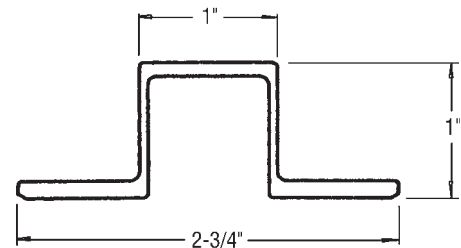

## Trailmobile Hat

90-4-1801-0-100 100"  
Aluminum

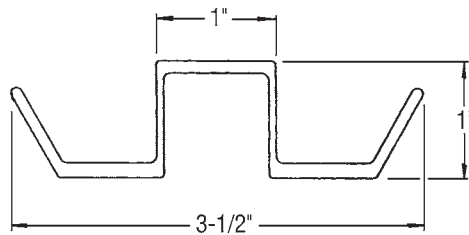

## Trailmobile Cambered Anti-Snag

9514-3-11-2 99-1/8"  
Aluminum

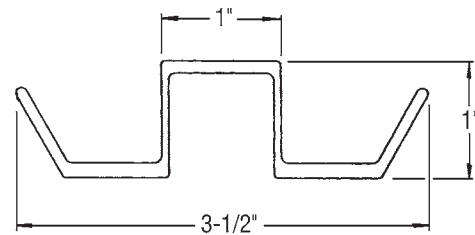

## Trailmobile Anti-Snag

90-4-1718-0-99 99-1/8"  
Aluminum

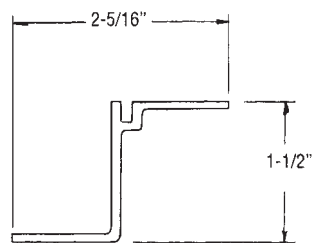

## Trailmobile Reefer

90-4-1714-0-109 109"  
Aluminum

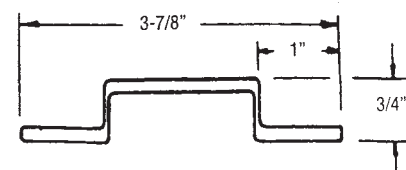

## Trailmobile Hi-Cube

90-4-1852-0-100 100"  
Aluminum

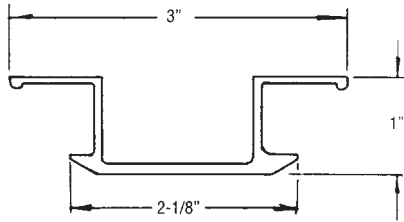

**Trailmobile  
"A" & "D" Model Hat**  
90-4-703-0-93 93-1/2"  
Aluminum

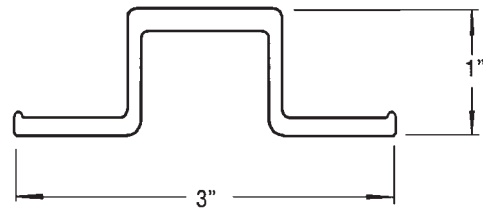

**Dorsey Cambered Hat**  
DO-RB01 98-11/16"  
Aluminum; Replaces 2808564

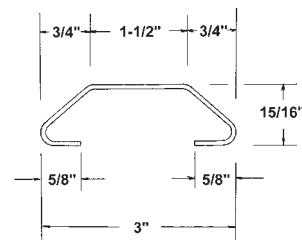

**Dorsey Anti-Snag**  
DO-RB02 98-5/8"  
Steel; Replaces 121069907

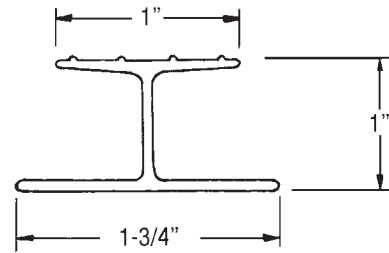

**Fruehauf I Beam**  
FR-RB01 99"  
Aluminum; Replaces RCC-008431

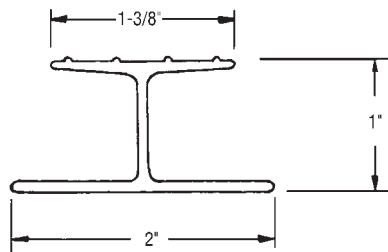

**Fruehauf I Beam**  
FR-RB02 99"  
Aluminum; Replaces RCF-004048-1

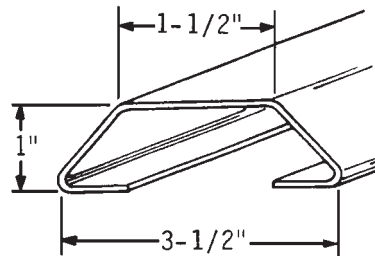

**Fruehauf Anti-Snag**  
FR-RB03 99"  
Aluminum; Replaces RCF-003718-1

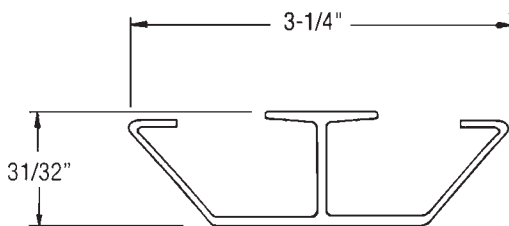

**Fruehauf Cambered Anti-Snag**  
FR-RB04 98-5/8"  
Replaces RCF-004335-4

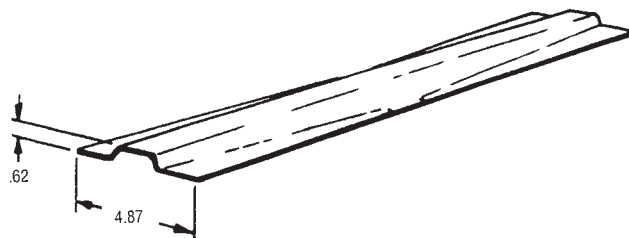

**Great Dane**  
GD-RB01 92-1/8"  
Aluminum; Replaces 08581

# Roofs - Roof Bows

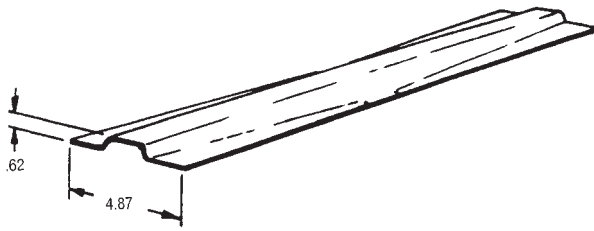

**Great Dane**  
**GD-RB02** 98-5/8"  
 Aluminum; Replaces 14113

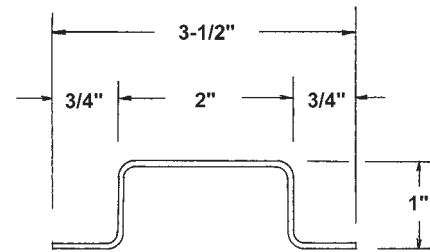

**Lufkin**  
**LU-RB01** 99"  
 Galvanized Steel; Replaces 88434

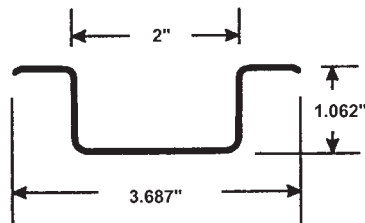

**Stoughton**  
**SO-RB01** 98-3/4"  
 3-Piece; Steel; Replaces 2306636

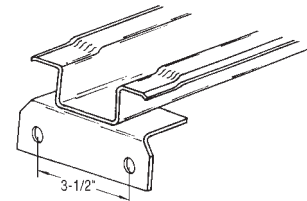

**Gindy-Strick**  
**514-3-143** 92-5/8"  
**514-3-143-0-99** 98-5/8"  
 16 Gauge Steel

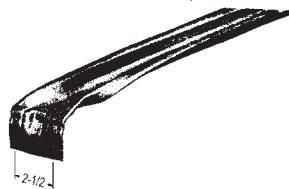

**Gindy-Strick**  
**514-3-140** 92-3/4"  
 Galvanized Steel; Replaces AA39C-0002-0100  
**514-3-140-0-99** 98-3/4"  
 Galvanized Steel; Replaces AA39C-0012-0100

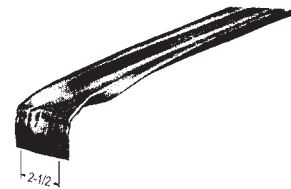

**Strick**  
**ST-RB01** 100-3/8"  
 Galvanized Steel; Replaces SK01512  
 and AA39C00210400

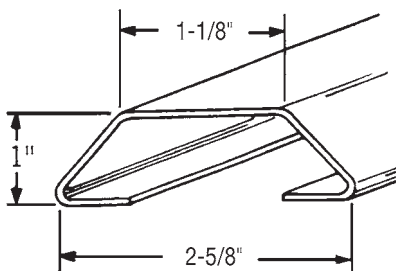

**Wabash Anti-Snag**  
**WA-RB01** 99"  
 Galvanized Steel; Replaces FC#03100028

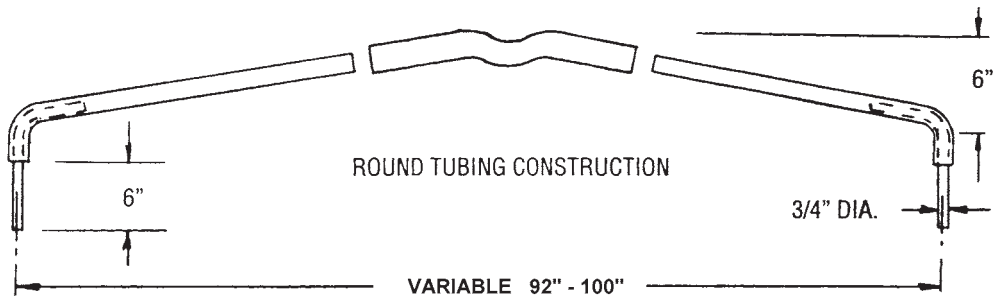

**Tarp Bow**  
700-514-1

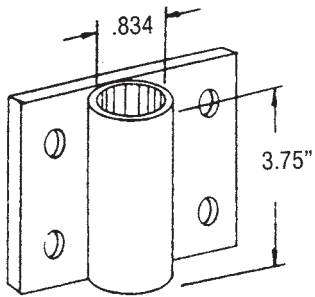

**Tarp Bow Socket**  
700-514-5

# Roofs - Sheets & Reinforcements



## ALUMINUM ROOF

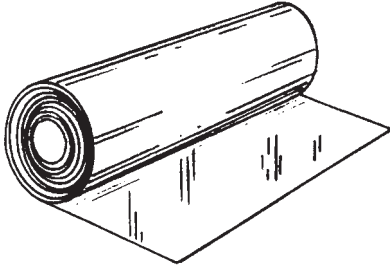

Part No.	Note	Description
514-5-191-102	Cut to requested length (58' Maximum)	Width: 103" Thickness: .0385" Weight: 4.663 lbs/ft
514-5-191-102B	Master Coil (Approx. 850' / 4000 lbs)	

## TRANSLUCENT ROOF

Part No.	Length	Width	Thickness
075X102X4	4'	102"	.075"
060X102X21	21'		.060"
060X102X25	25'		
060X102X31	31'	103"	.075"
KL-075X103X31ETR		102"	
075X102X50	50'		
075X102X55	55'	103"	
075X103X55			
KL-075X103X55ETR			
075X103X250	250'	500'	
075X103X500			
KL-075X103X500			

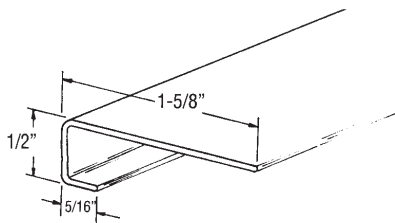

**Trailmobile Nose  
Rail Reinforcement**  
90-4-1563-0-126  
10'-6"; Aluminum

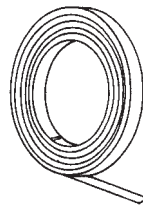

**Roof Sheet  
Reinforcement**  
700-514-31 50' Roll  
.040 Aluminum; 1-5/8" Wide

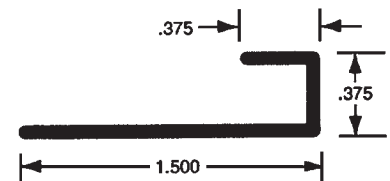

**J Moulding**  
700-514-32 10'-0"  
Aluminum

## TOP RAILS

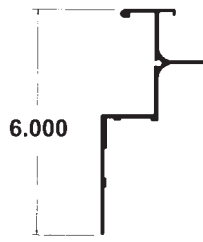

**MP-000056** 19'-1"

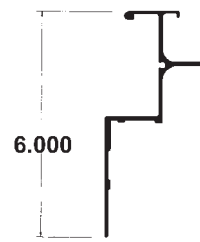

**MP-000096** 27'-1"

Model GVSD; for 1-3/8" Roof Bows

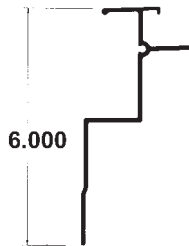

**MP-0001409** 27'-1"

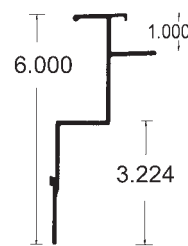

**MP-00015904** 27'-1"

Model GVSD; for 1" Roof Bows

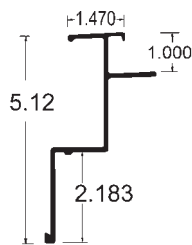

**MP-00033901** 27'-1"

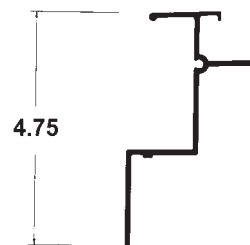

**MP-0001709** 27'-1"

Model GVFD; for 1" Roof Bows

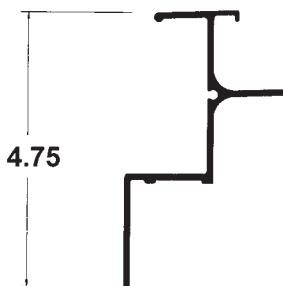

**MP-000085** 25'-1"  
Model GVFD; for 1-3/8" Roof Bows



# Morgan Truck Body



## BOTTOM RAILS

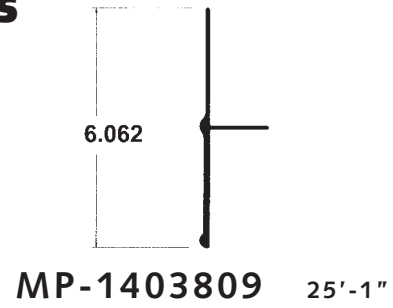
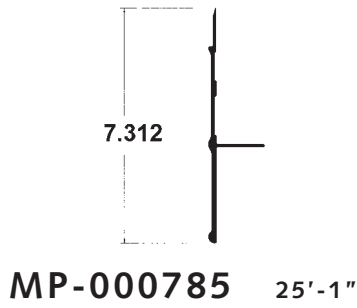

Model GVFD

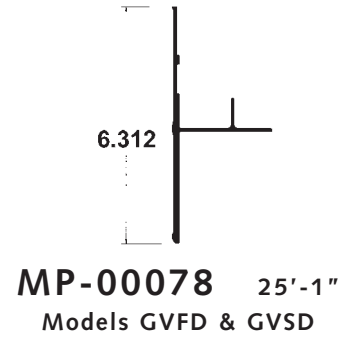
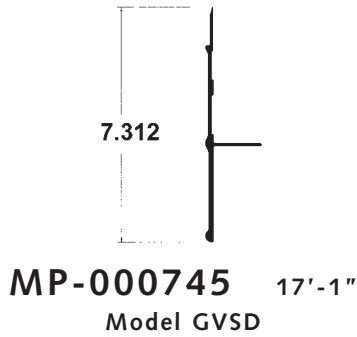

## SIDE POSTS

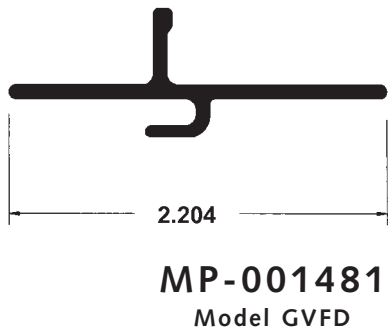

## Side Connectors

112-5/16"

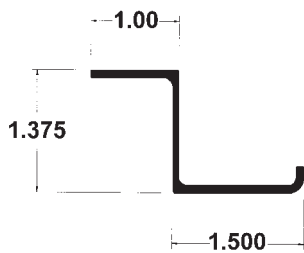
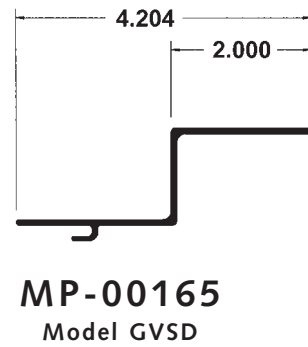

## Z Posts

109"

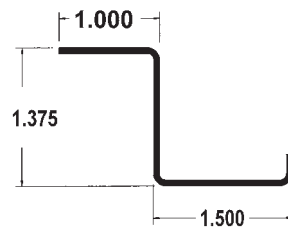

## ROOF BOWS

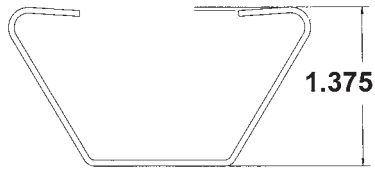

MP-01901 92"  
MP-01902 98"

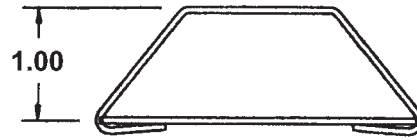

MP-019033 92"  
MP-019034 98"

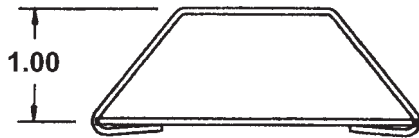

MP-019083 92"  
MP-019084 98"

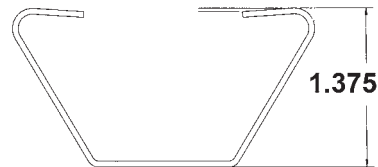

MP-12406 92"  
MP-12407 98"

## FRONT

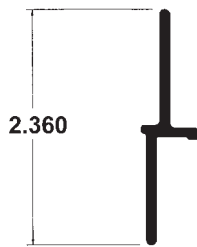

MP-00146 81"  
Model GVFD

## Top Connectors

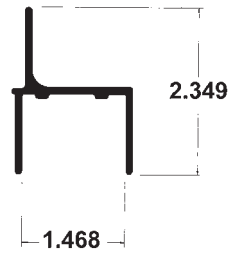

MP-14142 87"  
Model GVSD

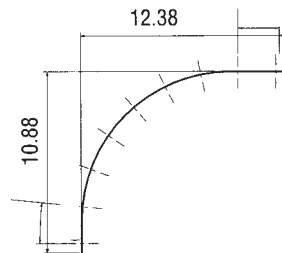

## Top Radius

MP-13500 80.88"  
MP-13502 86.88"  
Mill Finish

MP-006528 80.88"  
Penske Yellow

# Morgan Truck Body



## FRONT

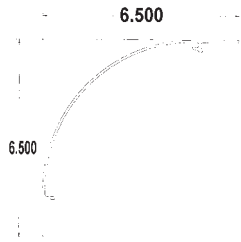

### Radius Panels

MP-00659 92-5/16"

MP-00660 104-5/16"

Mill Finish

MP-13547 92-5/16"

Stainless Steel

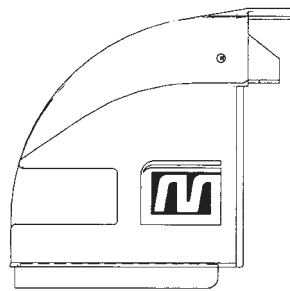

### Corner Caps

MP-006671 CS

MP-0066710 RS

Aluminum

MP-62660 CS

MP-62661 RS

MP-62664 CS

MP-62665 RS

Poly-Tuff

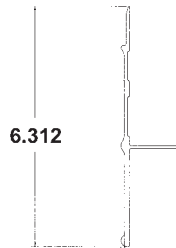

### Front Bottom Rail

MP-0010151 87"

### FRP Repair Panels

MP-6480161 3/8" X 4' X 8'

MP-6480285 1/2" X 4' X 8'

MP-648031 5/8" X 4' X 8'

## REAR

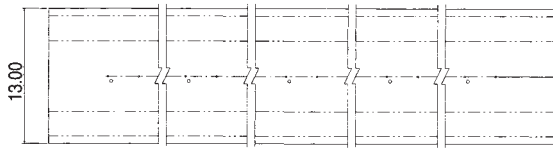

**Rear Header (Lower)**  
MP-1121813 94"

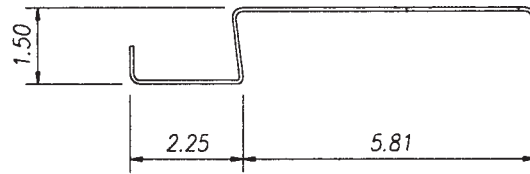

**Rear Header (Upper)**  
MP-1121823 102"

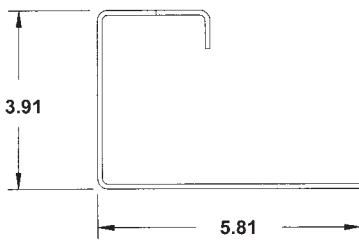

**Rear Corner Post**  
MP-1198653

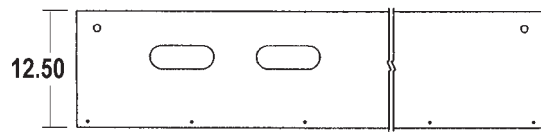

Curbside Shown

**Rear Corner Post (w/ Cut Outs)**  
MP-1198654 Curbside  
MP-11986540 Roadside



**Hinge Butt**  
MP-HB01 00671



**Hinge Butt**  
MP-HB02 087226

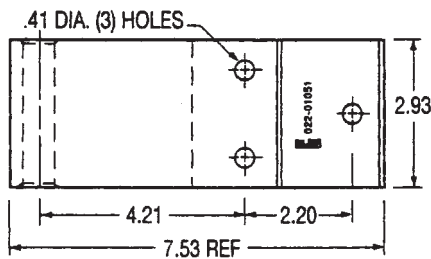

**Hinge**  
MP-HG01 004141  
3-Hole

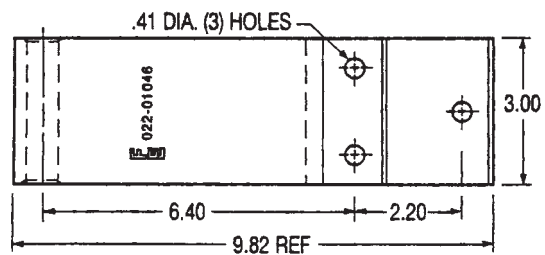

**Hinge**  
MP-HG02 004161  
3-Hole

## MISCELLANEOUS



### **Apitong Tie Slat**

MP-02192

3/4" X 2-5/8" x 16'



### **Penske Yellow Spray Paint**

MP-0985067

12 oz.



Curbside Shown

### **Ramp Handle**

MP-00695 Curbside

MP-00696 Roadside

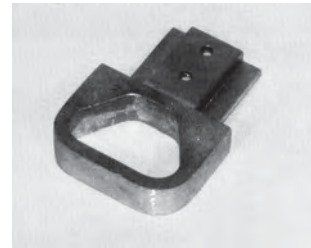

### **Walkramp Handle**

MP-0069601

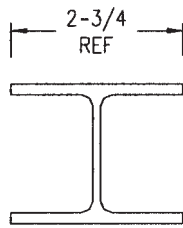

### 2-1/4" Steel I-Beam

1-3-965B

Length = 101.28"

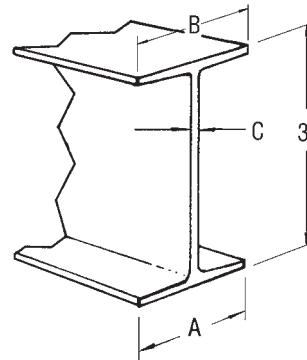

### 3" Steel I-Beam

700-90-24 80,000 PSI Yield

A = 2-1/4"; B = 2-1/4"; C = .087"; Length = 102"

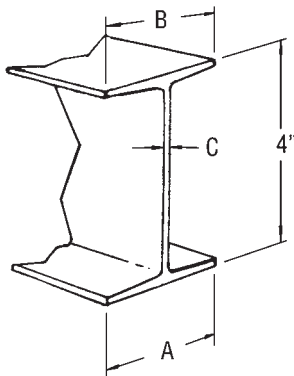

### 4" Steel I-Beam

90-4-1398-0-102 80,000 PSI Yield

A = 2-1/4"; B = 2-1/4"; C = .092"; Length = 101-1/2"

### 4" Steel I-Beam

GD-CM01

Punched; Length = 101.35"; Replaces 14089

### 4" Steel I-Beam w/ Clip

UT-CM01

Length = 101.75"; Replaces 4-2575-102

### 4" Steel I-Beam w/ Clip

UT-CM02

Length = 101.75"; Replaces 4-2575-69

# Under Frame - Crossmembers

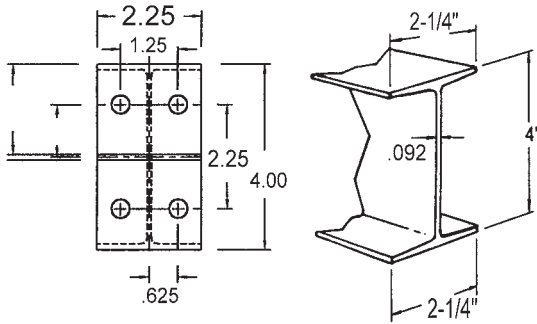

**4" Steel I-Beam w/ Clip**  
**6001-A3-101B**  
 Length = 101-5/8"

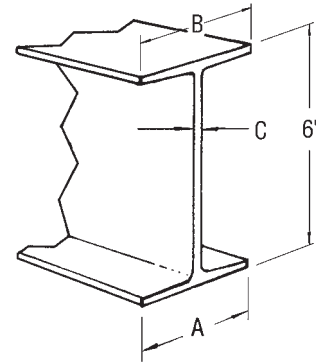

**6" Steel I-Beam**  
**90-4-1753-0-102** 80,000 PSI Yield  
 A = 2"; B = 2"; C = .106"; Length = 1-2"

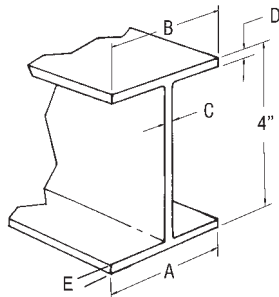

**4" Aluminum**

Part No.	A	B	C	D	E	Length
90-4-236-0-101	4"	4"	.100"	.160"	.160"	101"
90-4-1694-0-102	3"	3"	.170"	.290"	.290"	101-1/2"
90-4-2360-0-101	3"	2-1/2"	.135"	.235"	.245"	100-13/16"

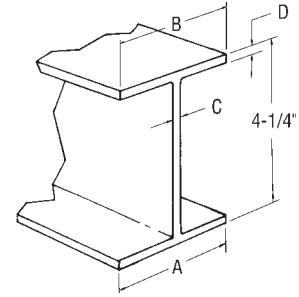

**4-1/4" Aluminum**  
**90-4-1608-0-101**  
 Length = 100-13/16"  
 A = 2-3/4"; B = 2-3/4";  
 C = .135"; D = .235"

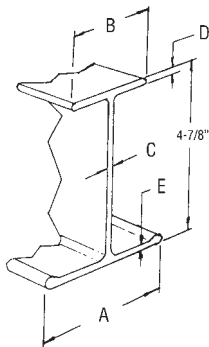

**4-7/8" Aluminum**  
**90-4-871-0-99** Length = 99"  
 A = 2-3/4"; B = 2"; C = .125";  
 D = .188"; E = .156"

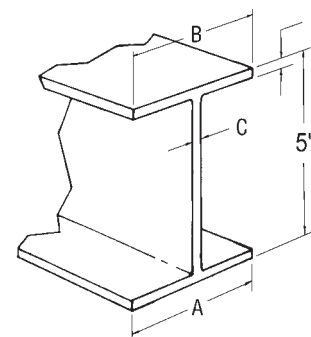

**5" Aluminum**  
**90-4-2028-0-102** Length = 101-5/8"  
 A = 2-1/2"; B = 2-1/2";  
 C = .120"; D = .180"



### Mylar Tape

700-99-283 4" X 216'  
700-99-140 6" X 216'

### Trailmobile Crossmember Clips (for 4" Crossmembers)

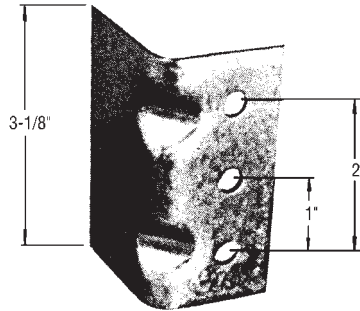

1-15-1631  
Galv. Steel

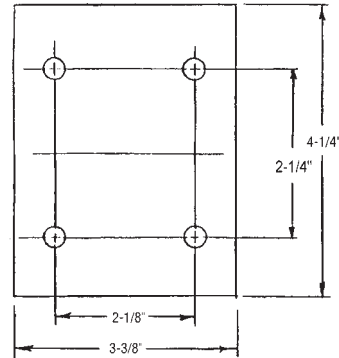

1-15-1632  
8 Ga. Steel

### Trailmobile Crossmember Clips (for 4-1/4" Crossmembers)

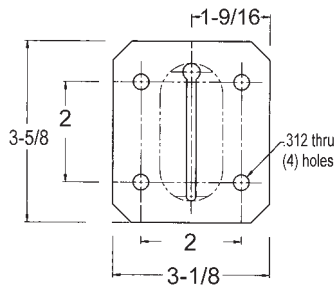

**Universal Clip  
w/ Slot**  
700-1-62

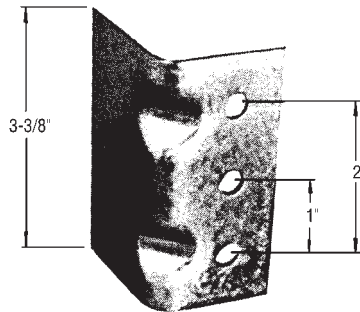

1-15-1567  
Galv. Steel

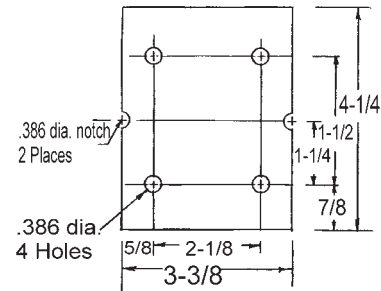

1-15-1569  
8 Ga. Steel

### Rail Fastener Kits

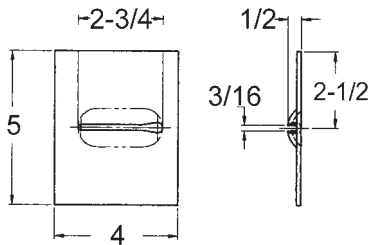

**Universal Clip  
Unpunched**  
700-1-66



700-50-16

Kit consists of:  
8 — 3/8" X 1-1/4" Bolts with Serrations  
8 — 3/8" Nuts with Flange  
8 — Nylon Washers



700-50-59  
Wabash Style



# Under Frame - Floors



## LAMINATED TRAILER FLOORING

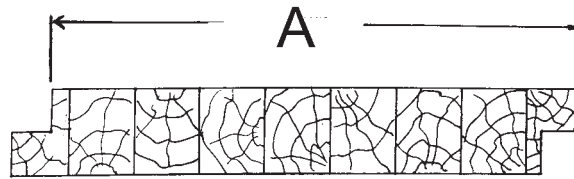

Part No.	Thickness	Material	Length	A
1-18X24-HWD	1-1/8"	Hardwood	24' 0"	12"
1-18X48-HWD			48' 1/4"	
1-18X52-HWD			52' 0"	
1-18X48	Oak	48' 1/4"		
1-14X24-HWD	1-1/4"	Hardwood	24' 0"	
1-14X48-HWD			48' 1/4"	
1-14X48			Oak	48' 1/4"
1-38X24-HWD	1-3/8"	Hardwood	24' 0"	14-1/2"
1-38X48-HWD			48' 1/4"	
1-38X52-HWD			52' 1-1/2"	
1-38X14.5X52-HWD		Oak	48' 1/4"	12"
1-38X48	Oak	48' 1/4"	52' 1-1/2"	12-7/32"
1-38WX52	Hardwood	52' 1-1/2"		

## FLOOR CHANNELS

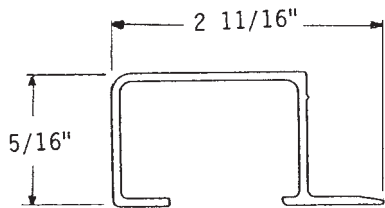

**90-4-2136-627** 52'-3"  
Aluminum  
1-3/8" Floor

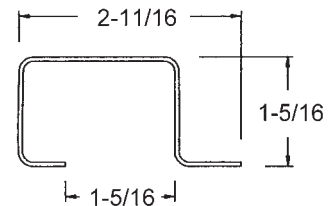

**90-4-2407-626** 52'-2"  
Steel  
1-3/8" Floor

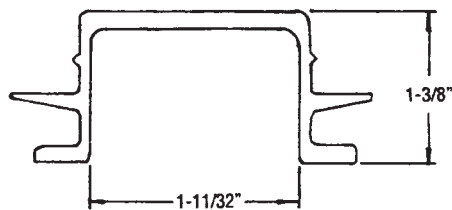

**90-4-1092-552** 46'-0"  
Aluminum  
1-3/8" Floor

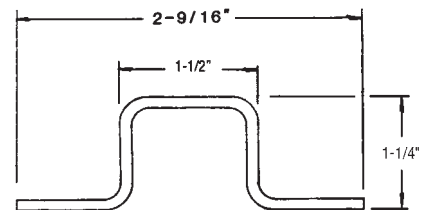

**90-4-1989-553** 46'-0"  
12 Ga. Steel  
1-1/4" Floor

## APITONG FLOORING

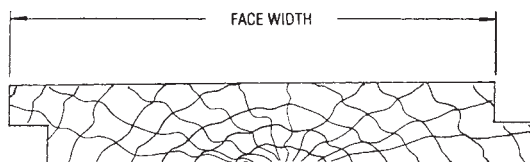

### Individual Apitong Boards

Part No.	Thickness	Face Width	Length
1-5/16X5X16	1-5/16"	5"	16'
1-5/16X7X16		7"	
1-125X5X16	1-1/8"	5"	
1-125X7X16		7"	15'
1-125X7X15			

### Apitong Floor Kits

Part No.	Thickness	7" Face Width	5" Face Width	Total Footage
1-516	1-5/16"	576'	100'	676'
1-125	1-1/8"			

Note: These kits contain random-length boards

## CONTAINER FLOORING

**700-519-8**

19-Ply  
1-1/8" X 4' x 8'

# Under Frame - Floors

## 1-1/4" CORRUGATED ALUMINUM FLOOR

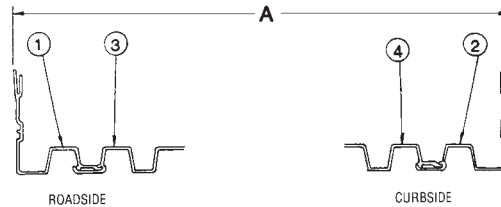

### 96" Wide Trailer

'A' FLOOR WIDTH		91"	90"	89"	87"
Item	Part No.	Qty	Qty	Qty	Qty
1	90-4-1745-618	1	1	1	1
2	90-4-1706-618	1	1	1	1
3	90-4-928-618	6	7	8	0
4	90-4-900-618	3	2	1	8

### 102" Wide Trailer or 102-3/8" Wide Trailer

'A' FLOOR WIDTH		97"	96"	95"	93"
Item	Part No.	Qty	Qty	Qty	Qty
1	90-4-1745-618	1	1	1	1
2	90-4-1706-618	1	1	1	1
3	90-4-928-618	0	1	2	4
4	90-4-900-618	9	8	7	5

## 1-1/4" CORRUGATED EX-A-GRIP ALUMINUM FLOOR

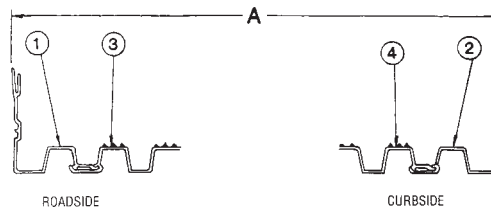

### 96" Wide Trailer

'A' FLOOR WIDTH		91"	90"	89"	87"
Item	Part No.	Qty	Qty	Qty	Qty
1	90-4-1745-618	1	1	1	1
2	90-4-1706-618	1	1	1	1
3	90-4-2059-618	6	7	8	0
4	90-4-2058-618	3	2	1	8

### 102" Wide Trailer or 102-3/8" Wide Trailer

'A' FLOOR WIDTH		97"	96"	95"	93"
Item	Part No.	Qty	Qty	Qty	Qty
1	90-4-1745-618	1	1	1	1
2	90-4-1706-618	1	1	1	1
3	90-4-2059-618	0	1	2	4
4	90-4-2058-618	9	8	7	5

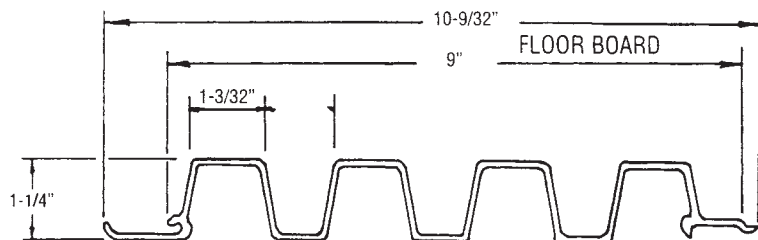

**Intermediate Board**

90-4-928-618 51'-6"

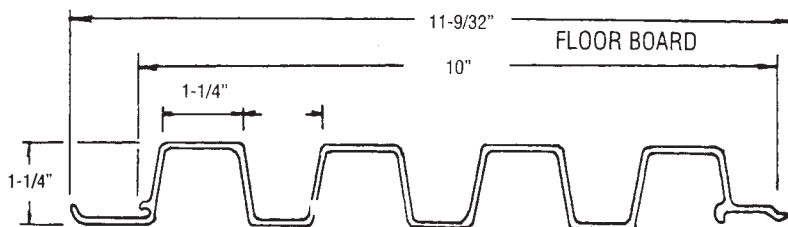

**Intermediate Board**

90-4-900-618 51'-6"

90-4-900-96 is an 8-ft section for patching

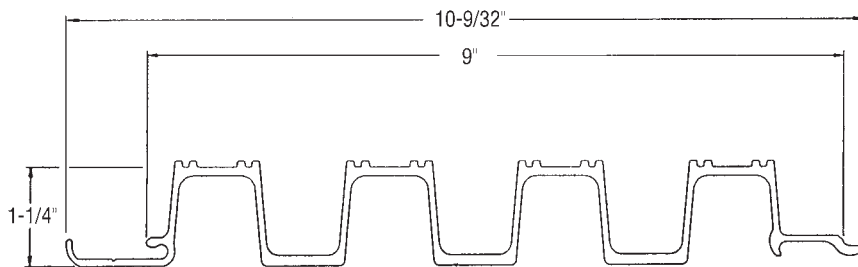

**Intermediate Board**

90-4-2059-618 51'-6"

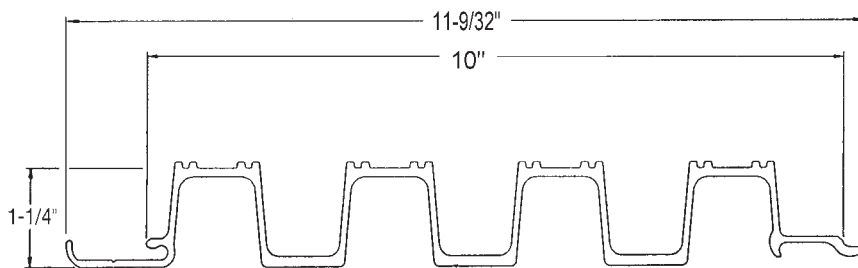

**Intermediate Board**

90-4-2058-618 51'-6"

# Under Frame - Floors

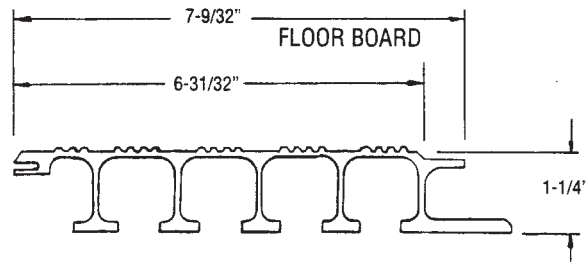

**Intermediate Board**  
90-4-1605-558 46'-6"

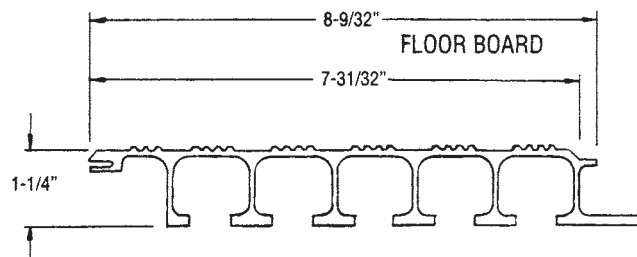

**Intermediate Board**  
90-4-1604-558 46'-6"

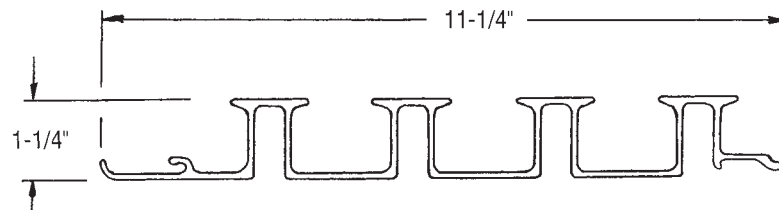

**Intermediate Board**  
90-4-1931-618 51'-6"

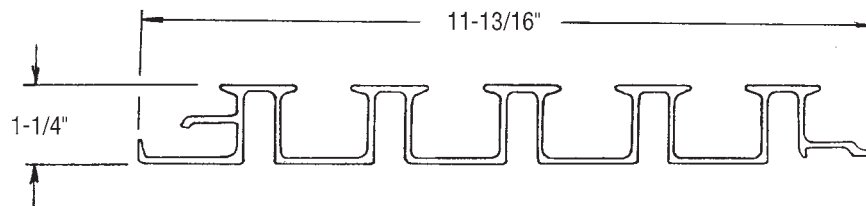

**Intermediate Board**  
90-4-2105-606 50'-6"

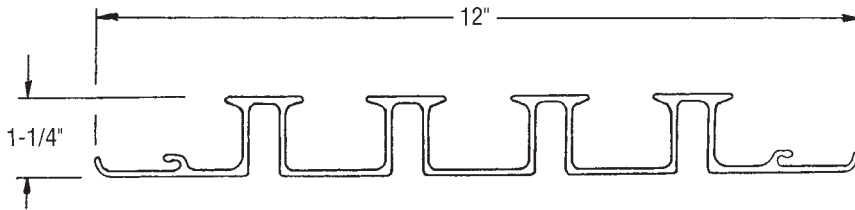

**Center Board**  
90-4-2106-606 50'-6"

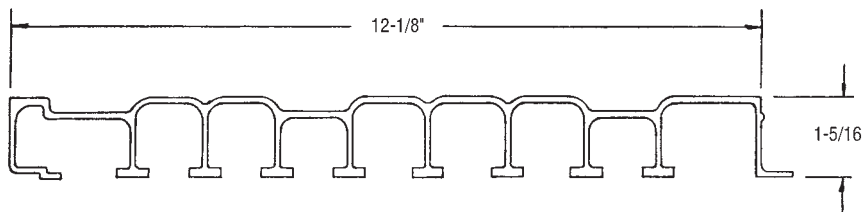

**Wood Replacement Aluminum Board**  
90-4-2303-580 48'-4"

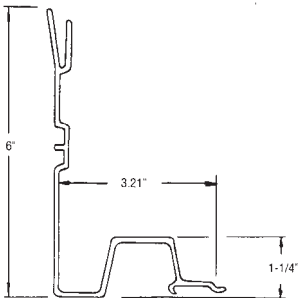

**Aluminum Edge Board - Male for Corrugated Floor**  
90-4-1745-618 51'-6"

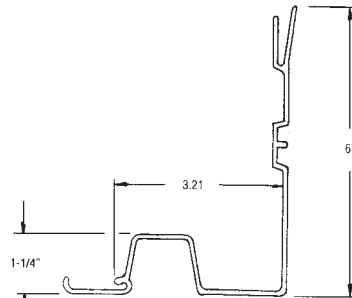

**Aluminum Edge Board - Female for Corrugated Floor**  
90-4-1706-618 51'-6"

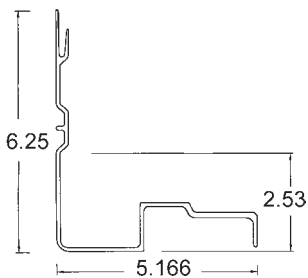

**Aluminum Edge Board**  
90-4-2159-618 51'-6"

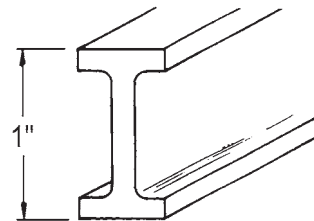

**Floor Board Insert**  
90-4-2306-0-48 48"  
Aluminum

# Under Frame - Floors

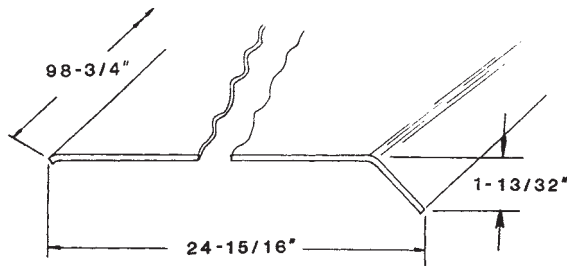

**1/8" Diamond Tread Plate**  
**523-6-722B-24**  
 Pre-drilled for 12" crossmembers

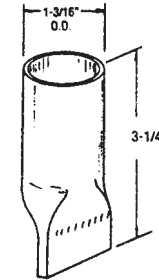

**Rear Gutter Drain Tube**  
**508-11-25**  
 Rubber

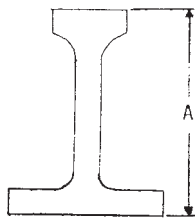

**Composite Floor Stringers**

Part No.	'A'	Length
90-4-1904-0-96	2"	96"
90-4-2101-0-96	2-1/2"	
90-4-1993-0-96	3"	

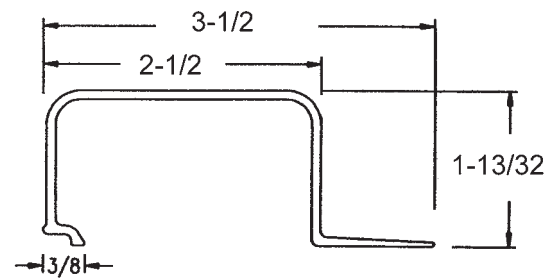

**Air & Electric Channel**  
**90-4-2309-561 46'-9"**

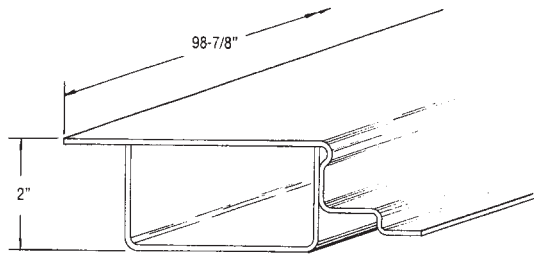

**"Can Haul"**  
512-A1-115-1-0-2

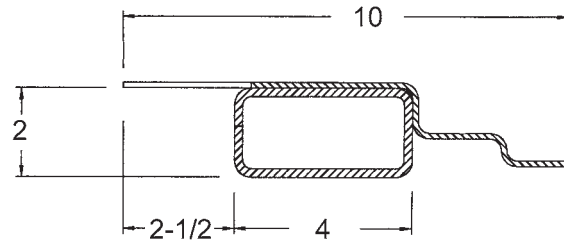

**Dry Freight w/ Swing Doors**  
9512-A1-135B-G  
Galvanized Steel

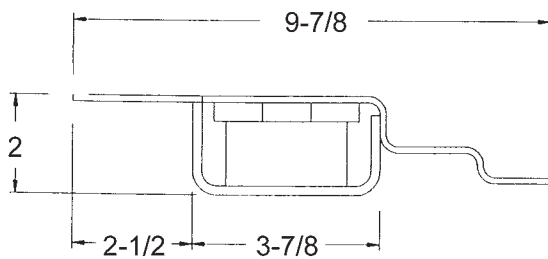

**Dry Freight w/ Swing Doors**  
512-A1-131B-1

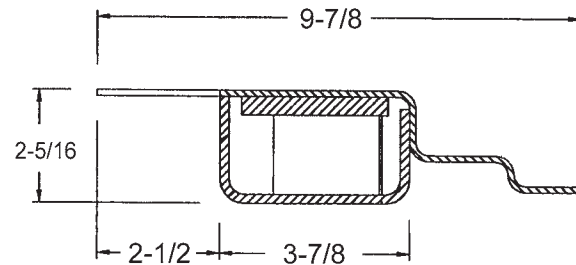

**Dry Freight w/ Swing Doors**  
512-A1-144B-1

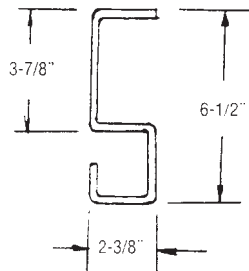

**"Concept II" w/ Roll-Up Door**  
512-1-189A-0-1

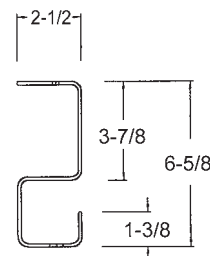

**Dry Freight w/ Roll-Up Door**  
512-1-221B-4-G-K  
Galvanized Steel

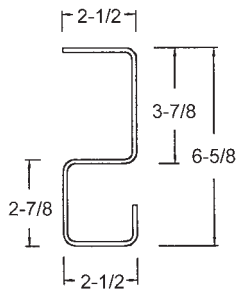

**ABF w/ Roll-Up Door**  
6512-1-113B-4-3-L  
Galvanized Steel



**Corner Iron**  
700-512-17 8" X 6"  
700-512-2 12" X 12"



# Rear Frame - Corner Posts



## Universal Corner Posts for Swing Doors

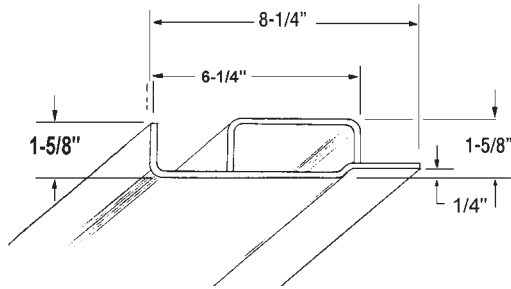

**599-512-7P** 130"

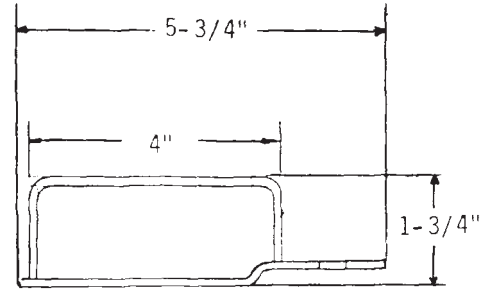

**700-512-9P** 131-7/8"

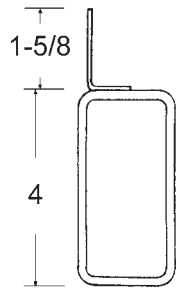

**700-512-12-1-G** 119-3/4"  
Galvanized Steel

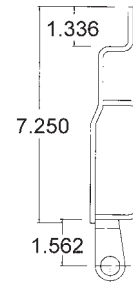

**6512-A3-4-1226-1-0-1** 126-3/16"

## Universal Corner Posts for Dry Freight Roll-Up Doors

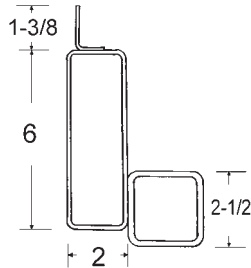

**700-512-18-G** 118-3/4"  
Galvanized Steel

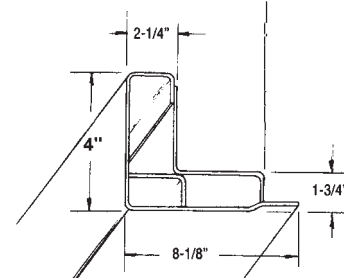

**700-512-5A** 130"

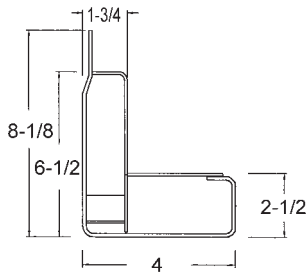

Roadside shown

### ABF Corner Post

**6512-A3-12L-1206-431** Roadside  
**6512-A3-13R-1206431A** Curbside  
Galvanized Steel

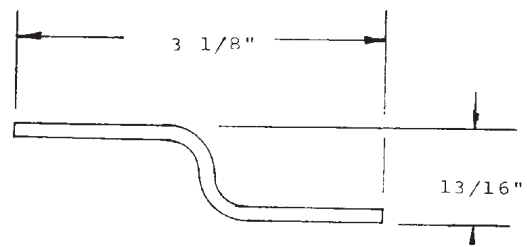

### Plywood Attachment Post

**519-3-418-0-FO** 103"  
12 Ga. Steel

## Bolsters for Swing Doors

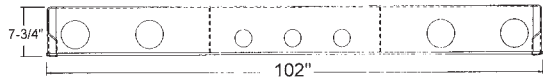

**512-A8-172B-1**

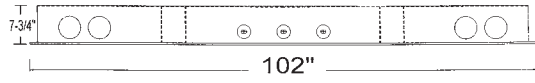

**512-A8-173B-1-1**

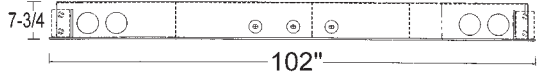

**512-A8-189B-1**

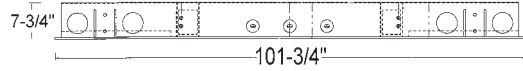

**6512-A8-113B-1-1-K-B**

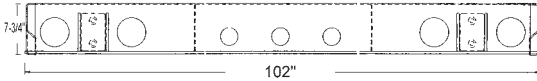

**9512-A8-377B-1**

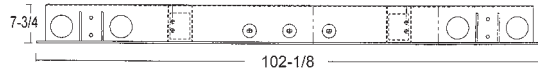

**9512-A8-417B-1GKD-SP**  
Galvanized Steel

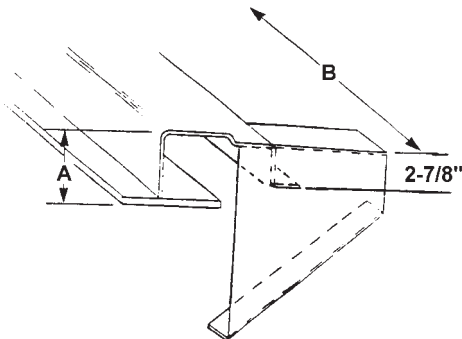

**512-A8-156B**  
A = 4-1/4"; B = 102-3/8"



**Bolster for ABF Roll-up Door**  
**6512-A8-117B-3KD-SP**  
Galvanized Steel

# Rear Frame - Bumpers

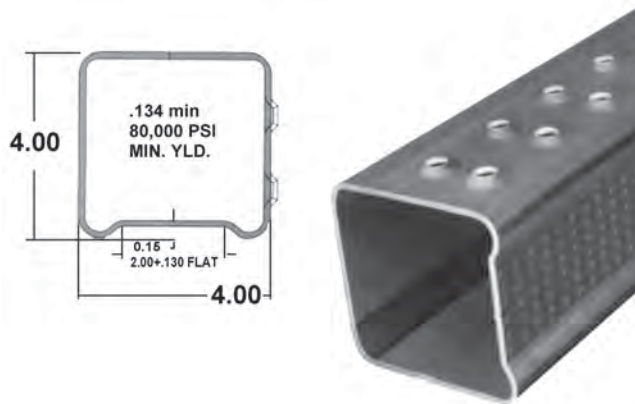

## Horizontal Bumper Tube with Anti-Skid & Conspicuity Tape

BK-TB0273-07V5N002KT

94-3/8" Long

11-1-385B-GALV

Galvanized Version



## Stainless Steel Horizontal Bumper Tube with Conspicuity Tape

11-1-375B-2-KIT 94-3/8" Long

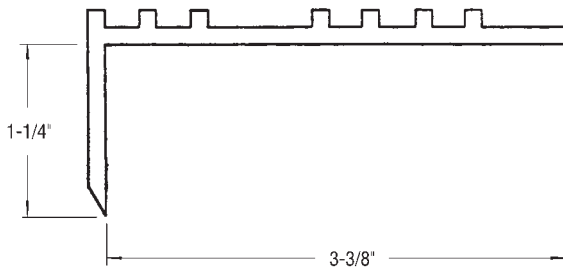

## Bumper Anti-Skid Plate

90-4-2119-0-16 16" Long  
Aluminum



## Dock Lock Channels

9011-1-530  
9011-1-530G Galvanized

## Universal for Curbside or Roadside



29-A4-132-2 Steel  
29-A4-132-2-6 Stainless Steel



29-A4-132-3 Steel  
29-A4-132-3-6 Stainless Steel

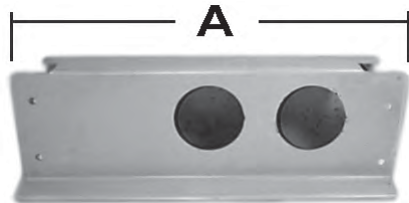

A = 30" 29-A4-94-2 Curbside Shown  
Steel 29-A4-95A-2 Roadside Opposite

A = 24-11/16" 29-A4-101-2A Curbside  
Steel 29-A4-102-2A Roadside



Steel 9029-A4-361-2 Curbside Shown  
9029-A4-359-2 Roadside Opposite

Stainless Steel 9029-A4-361-2-6 Curbside  
9029-A4-359-2-6 Roadside



29-4-318R Curbside Shown  
29-4-318L Roadside Opposite  
Steel



29-4-351R Curbside Shown  
29-4-351L Roadside Opposite  
Steel



29-4-317R Curbside Shown  
29-4-317L Roadside Opposite  
Steel



Part No.	Usage	Frame Dimensions	Cut Out Dimensions	Color	Depth	Screen	Cross to Penz
700-520-14	Dry Freight	10-1/2" X 23"	7-1/2" X 20"	White	1"	No	P-2010
700-520-13		13-1/4" X 23"	10-1/4" X 20"	Bare Aluminum	3/4"	No	P-4010
700-520-12		14-3/4" X 20-1/2"	11-1/2" X 17-1/4"	Bare Aluminum	3/4"	Yes	P-1077
700-520-19				White			P-1077
520-0-59		16-1/4" X 23-1/4"	13-1/4" X 20-1/4"	White	1"	No	P-5010
520-0-81Z	Reefer	7" X 20"	5-1/2" X 17"	Stainless Steel	4"	Yes	P-1084
520-0-58		10-1/2" X 23"	7-1/2" X 20"	White	3-1/8"	No	P-2000
520-0-58A				Stainless Steel			P-2000
520-0-79				White			2" - 3"
520-0-57		16-1/4" X 23-1/4"	13-1/4" X 20-1/4"	White	3-1/8"	No	P-5000
520-0-78Z				Stainless Steel	2" - 3"	Yes	P-5200
520-0-72		Reefer-Curved	10-1/8" X 23-1/4"	7-1/4" X 19-7/8"	White	3-1/8"	No
520-0-72A	Stainless Steel				P-2000RAD		

### Hold Back Plungers

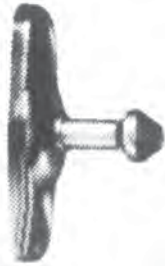

700-520-16 1-5/8"

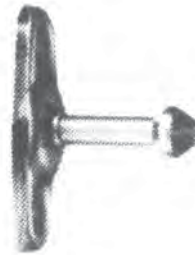

700-520-17 2-1/8"



**Hold Back Socket**  
700-520-18

### Vent Door Latches



520-A11-7  
Stainless Steel



700-520-10 Zinc Plated  
700-520-15 Stainless Steel

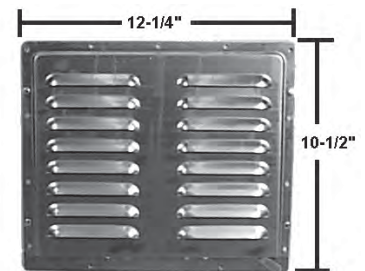

**Louver Vent**  
700-520-7  
Aluminum

## Grab Handles

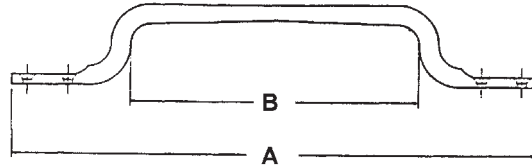

Part No.	Finish	A	B	Mounting Hole Diameter
50-57-6C	Chrome	12-15/16"	7-1/8"	7/32"
9050-57-3		29-11/16"	24-1/2"	9/32"
9050-57-1		41-11/16"	36-1/2"	

## Truck Body U-Bolts



Part No.	Dimensions
700-3-94	5/8" X 3-1/2" X 14"
700-3-95	5/8" X 3-1/2" X 16"
700-3-96	5/8" X 3-1/2" X 18"
700-3-97	5/8" X 3-1/2" X 20"
700-3-98	5/8" X 3-1/2" X 22"

Each Kit Contains: 4 U-Bolts  
4 Tie Plates  
8 Nuts  
8 Washers



**Folding Step**  
522-2-1  
Zinc Plated

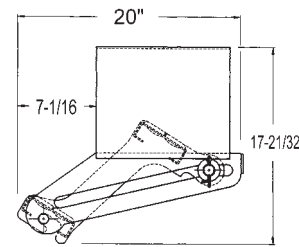

**Retractable Step Assembly**  
PZ-08-02

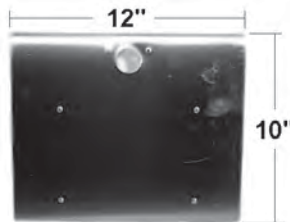

**License Plate Bracket**  
29-4-461C  
Stainless Steel



**O.V.G. Hopper Gate Gear**  
32-2-19



**Sky Light**  
50-A91-8 For 12" Dia. Hole  
50-A91-6 For 16" Dia. Hole

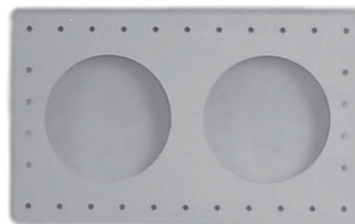

**Side Mount Sky Light**  
700-99-232  
4" Dia. Holes

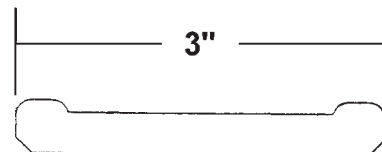

**Flat Bed Skid Rail**  
90-4-1983-618  
51' 5-11/16"  
Aluminum

<b>PLYMETAL DOOR BLANKS AND DOOR OVER LAY SHEETS .....</b>	<b>8-1</b>
<b>SEALS AND RETAINERS .....</b>	<b>8-2 TO 8-4</b>
<b>REAR DOOR HINGES .....</b>	<b>8-5 TO 8-17</b>
<b>HINGE BUTTS .....</b>	<b>8-18 TO 8-19</b>
<b>HINGE PINS .....</b>	<b>8-19</b>
<b>DOOR HOLD BACKS .....</b>	<b>8-20 TO 8-21</b>
<b>REAR DOOR LOCKS .....</b>	<b>8-22 TO 8-26</b>
<b>REEFER REAR DOORS .....</b>	<b>8-27 TO 8-31</b>
<b>DRY FREIGHT SIDE DOORS .....</b>	<b>8-32 TO 8-34</b>
<b>REEFER SIDE DOORS .....</b>	<b>8-35 TO 8-38</b>
<b>TODCO ROLL-UP DOORS .....</b>	<b>8-39 TO 8-47</b>
<b>LISTING OF GENERIC PARTS THAT CAN REPLACE TODCO .....</b>	<b>8-47 TO 8-48</b>
<b>WHITING ROLL-UP DOORS .....</b>	<b>8-49 TO 8-59</b>
<b>LISTING OF GENERIC PARTS THAT CAN REPLACE WHITING ...</b>	<b>8-59 TO 8-60</b>
<b>ROLL-UP DOOR FASTENERS .....</b>	<b>8-60</b>
<b>SWING TO ROLL-UP CONVERSION KIT .....</b>	<b>8-61</b>

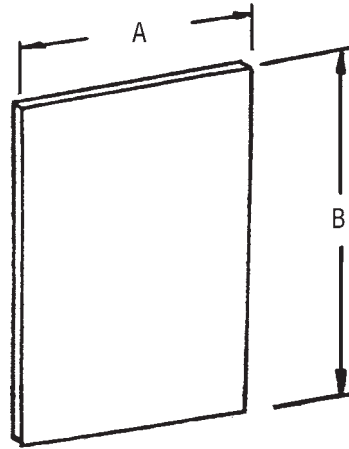

Part No.	Thickness	A	B	Outside Finish	Inside Finish
700-515-69	1/2"	49"	108"	.015 PPW Aluminum	.015 Bare Aluminum
700-515-70			120"		
700-515-71	108"				
700-515-102	110-1/2"				
700-515-142	120"		26 Ga. Galvanized Steel		
700-515-72			.015 Bare Aluminum		
700-515-96			26 Ga. Galvanized Steel		
700-515-89			.015 Bare Aluminum		
700-515-90	.021 Stainless Steel				
700-515-97	.024 PPG Aluminum				
700-515-75	1"		145"	.015 PPW Aluminum	26 Ga. Galvanized Steel
700-515-103			108"	.015 PPW Aluminum	
700-515-76			110-1/2"	26 Ga. PPW Steel	
700-515-99	1-1/4"		120"	.015 PPW Aluminum	.015 Bare Aluminum
700-515-104		110-1/2"	26 Ga. PPW Steel	26 Ga. Galvanized Steel	
700-515-79		120"	.015 PPW Aluminum	.015 Bare Aluminum	
700-515-92			26 Ga. Galvanized Steel		
700-515-100			26 Ga. PPW Steel	26 Ga. Galvanized Steel	

## DOOR OVER LAY SHEETS

Part No.	Material	Description	A	B
700-515-110	24 Ga. Bright Stainless Steel	Quilted (3" Diamond)	48"	110-1/4"
700-515-106		Flat Plate		112"



# Seals and Retainers



## SEALS

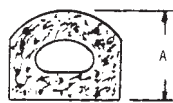

### Trailmobile Compression Seal

Part No.	Length	A
90-4-1962-0-120	10'	5/8"
90-4-1867-0-1200	100'	3/4"

Use with retainer 90-4-1857-0-165

## RETAINERS

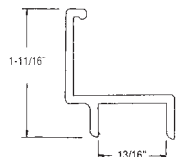

### Trailmobile Aluminum Retainer

90-4-1857-0-165

165" long; use with seals  
90-4-1867 or 90-4-1962

## SLAMS

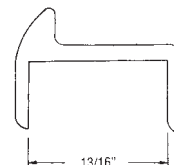

### Trailmobile Aluminum Slam

90-4-1861-0-115

115" long; use with retainer  
90-4-1857-0-165

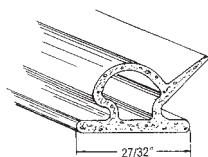

### Trailmobile Flexible Seal

90-4-828-0-120

120" long; use with retainer  
90-4-1049-0-120

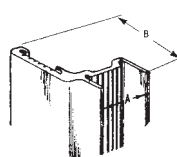

### Trailmobile Aluminum Retainer

90-4-1049-0-120

120" long; use with seal  
90-4-828-0-120;  
A = 13/16" B = 1-1/2"

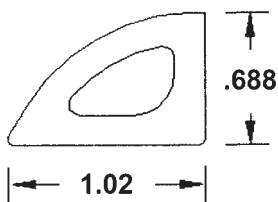

### Dorsey Seal DO-DS01

Replaces 5253094; use with  
retainer 700-90-69-0-168

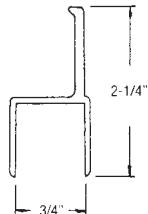

### Dorsey Aluminum Retainer

700-90-69-0-168

168" long; use with seal  
DO-DS01

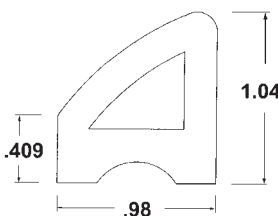

### Great Dane Seal GD-DS01

Replaces 45985; use with  
retainer 700-90-47-0-168

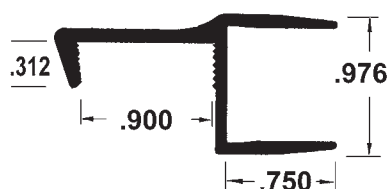

### Great Dane Aluminum Retainer

700-90-47-0-168

Replaces 95573; 168" long;  
use with seal GD-DS01

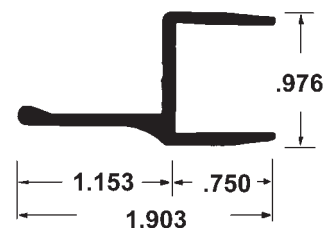

### Great Dane Aluminum Slam

700-90-46-0-120

Replaces 95583; 120" long; use  
with retainer 700-90-47-0-168

## SEALS



### Newcourt Tru-Sealer Vinyl Seal

700-90-44 168"  
Use with retainer 700-90-43

## RETAINER

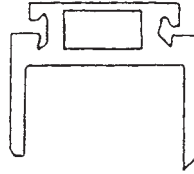

### Newcourt Tru-Sealer Aluminum Retainer

700-90-43 168"  
For 3/4" door thickness

## SEAL & RETAINER

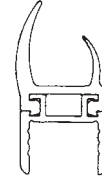

### Newcourt Tru-Sealer Retainer and Seal

700-90-87 168"  
For 3/4" door thickness

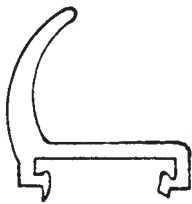

### Newcourt Tru-Sealer Vinyl Seal

700-90-42-0-122 122"  
Use with retainer 700-90-43

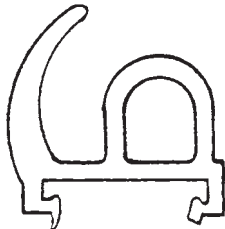

### Newcourt Tru-Sealer Balloon Gasket

700-90-41-0-168 168"  
Use with retainer 700-90-43

# Seals and Retainers

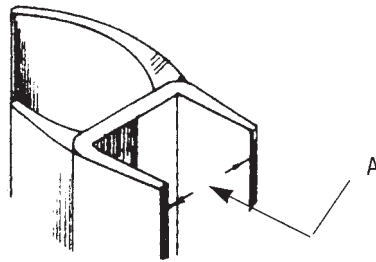

Part No.	Door Thickness	A	Length	Note
WH-58R-8-14	1/2"	9/16"	14'	Whiting Sea-Lok
90-4-819-0-168				Generic Dual-Durometer
WH-58R-12-9	3/4"	13/16"	9'-8"	Whiting Sea-Lok
WH-58R-12-14			14'	Todco DuraSeal
TO-70374				Generic Dual-Durometer
90-4-820-0-168				Generic Dual-Durometer No Sealing Beads
700-90-141-0-168				
WH-58R-16-9			1"	1-1/16"
WH-58R-16-14	14'	Generic Dual-Durometer		
90-4-821-0-168				
WH-58R-20-9	1-1/4"	1-5/16"	9'-8"	Whiting Sea-Lok
WH-58R-20-14			14'	Generic Dual-Durometer
90-4-822-0-168				
WH-58R-24-9	1-1/2"	1-9/16"	9'-8"	Whiting Sea-Lok
WH-58R-24-14			14'	



## Sea-Lok Repair

Item	Part No.	Description
1	WH-58A-1	Adhesive
2	WH-58S-1	Sealant
3	WH-58T-1	7/8" Outside Tab
	WH-58T-3	1-1/4" Outside Tab
4	WH-58CF-20	Corner Angle

## Corner Repair

**700-515-154**  
3/4" X 18" X 18"

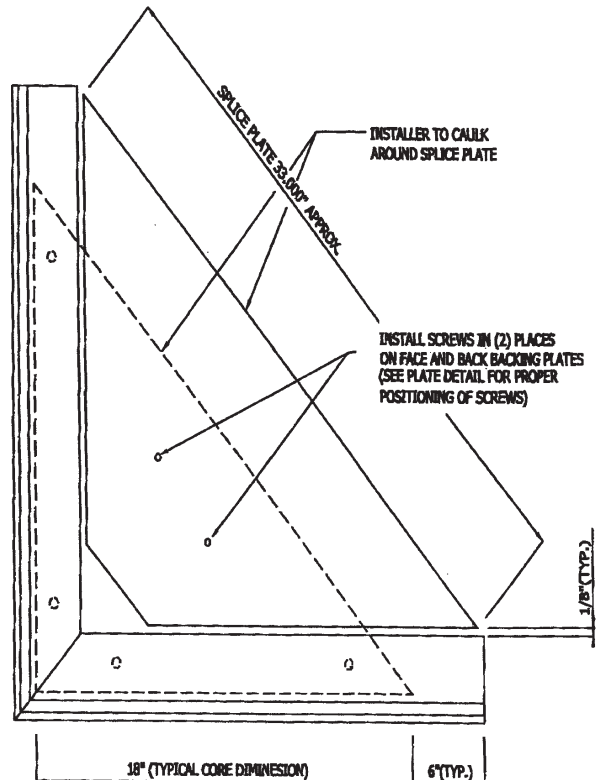

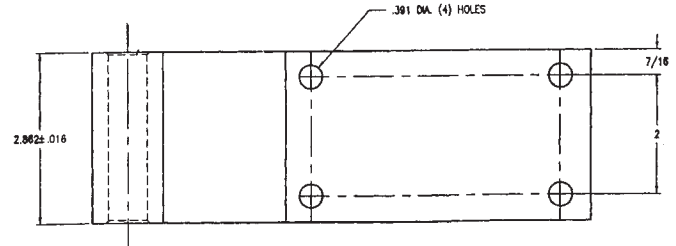
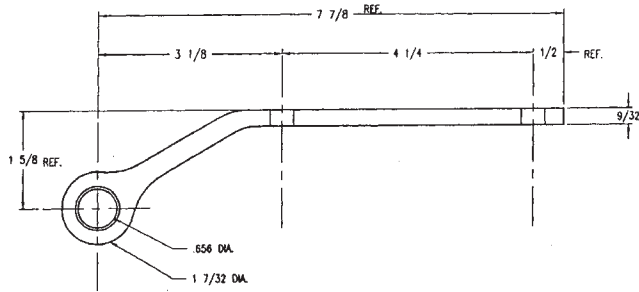

**Trailmobile 4-Hole Aluminum Hinge**  
515-10-75

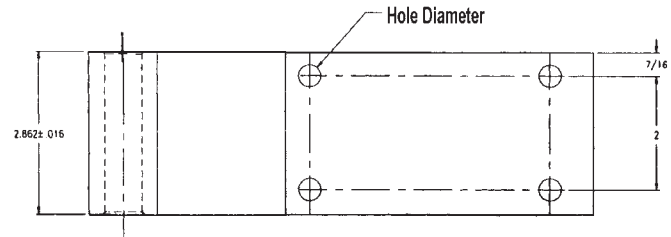
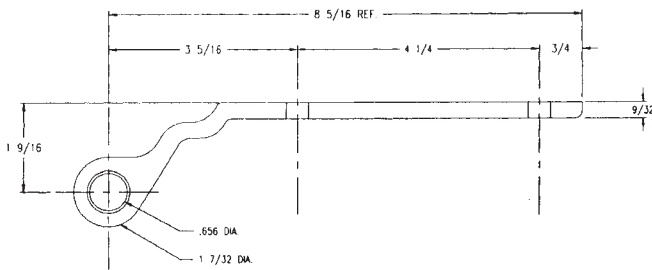

**Trailmobile 4-Hole Aluminum Hinges**

**515-10-78-1**  
.257 Hole Dia

**515-10-78-2**  
.391 Hole Dia

**515-10-78-3**  
.406 Hole Dia

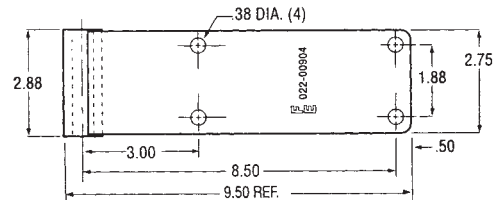
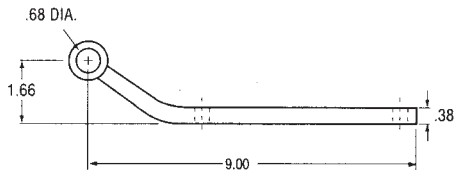

**Trailmobile 4-Hole Steel Hinge**  
515-A10-13



2-1/2" X 6" Mounting Holes  
3-1/2" X 12-13/16" Overall  
Uses 5/8" Diameter Pin

**Trailmobile 4-Hole Steel Hinge**  
515-10-55

# Rear Door Hinges

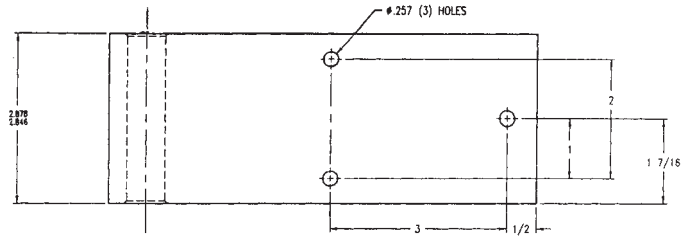
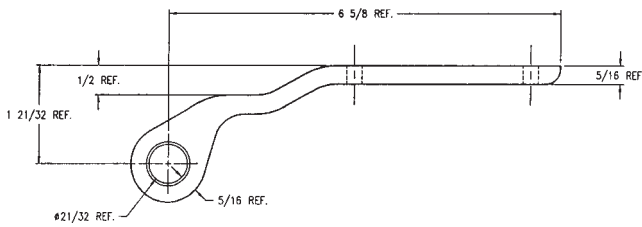

## Trailmobile 3-Hole Aluminum Hinge

515-10-65

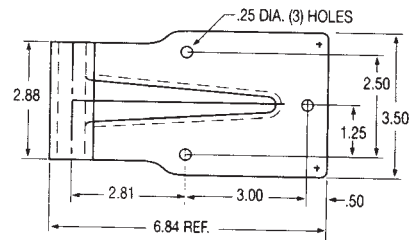
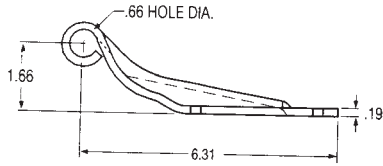

## Trailmobile 3-Hole Steel Hinge

515-10-73A

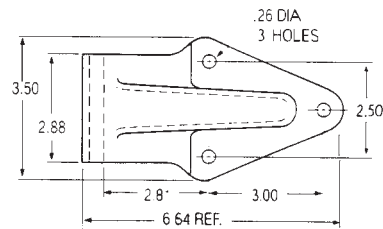
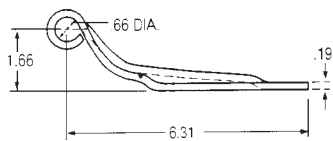

## Trailmobile 3-Hole Steel Hinge

515-10-61A

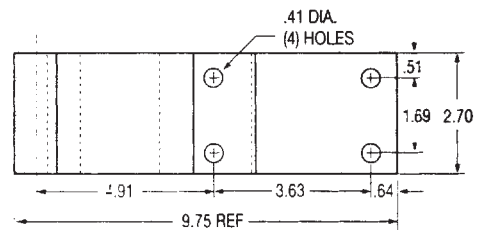
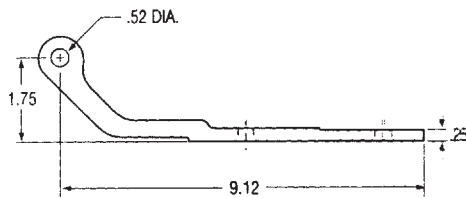

## Dorsey 4-Hole Aluminum Hinge

700-515-117

Replaces 2810093

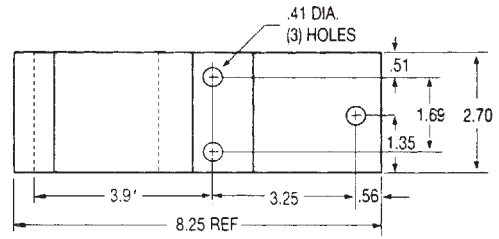
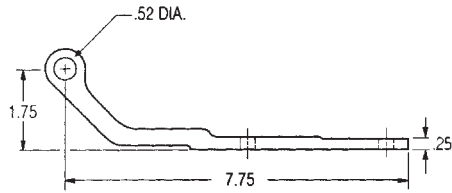

## Dorsey 3-Hole Aluminum Hinge

700-515-122

Replaces 2810919

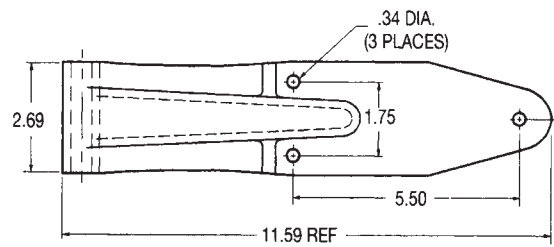
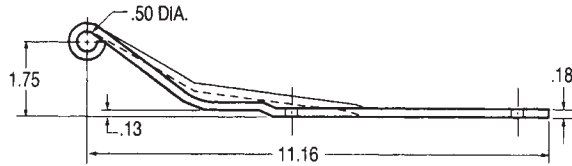

## Dorsey 3-Hole Steel Hinge

DO-HG01

Replaces 4101481

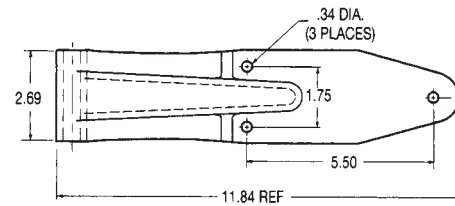
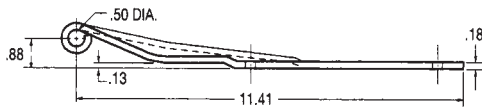

## Dorsey 3-Hole Steel Hinge

DO-HG02

Replaces 4101482

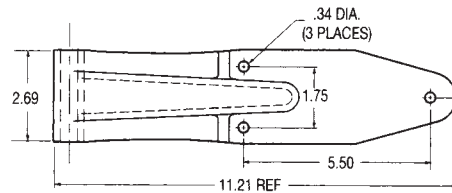
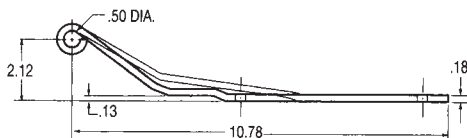

## Dorsey 3-Hole Steel Hinge

DO-HG03

Replaces 5609022

# Rear Door Hinges

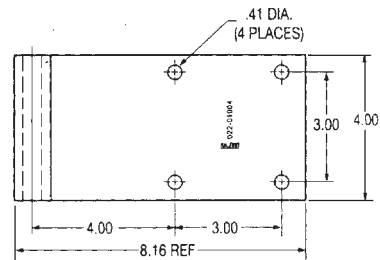
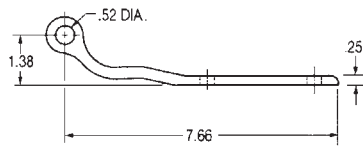

## Fruehauf 4-Hole Aluminum Hinge

700-515-120

Replaces BCF-4678-1

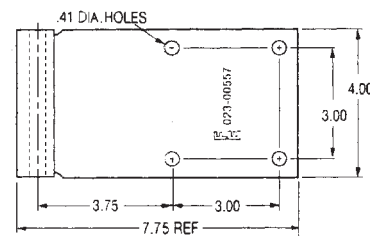
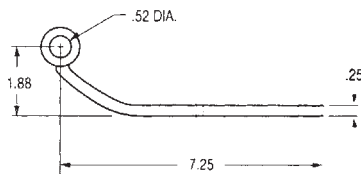

## Fruehauf 4-Hole Steel Hinge

700-515-45

Replaces DCE-8681-1

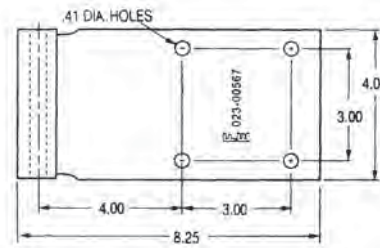
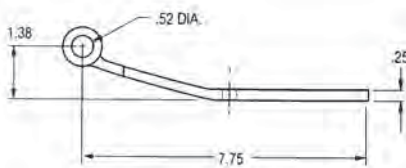

## Fruehauf 4-Hole Steel Hinge

700-515-83

Replaces DCF-3980-1

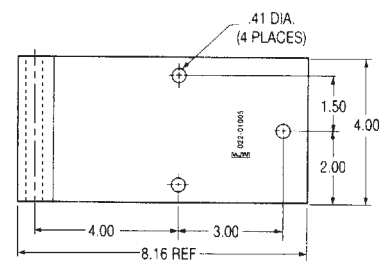
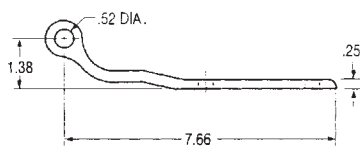

## Fruehauf 3-Hole Aluminum Hinge

700-515-128

Replaces DBA-158300



## Fruehauf 3-Hole Steel Hinge

700-515-8

Replaces DCA-02-42



## Fruehauf 2-Hole Steel Hinge

700-515-9

Replaces DXA-0687



## Fruehauf Dry Freight Hinge Kit

700-515-43

- Kit contains:  
 1 - 700-515-9 Hinge  
 2 - 700-515-15 Screws  
 2 - 700-515-16 Nuts



## Dry Freight Screw

700-515-15

## Dry Freight Nut

700-515-16

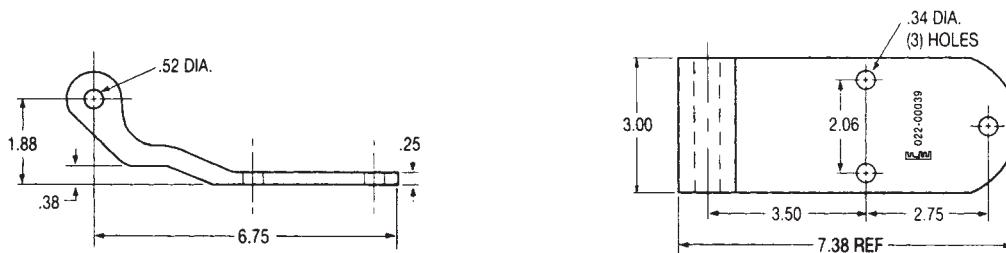

## Gindy 3-Hole Aluminum Hinge

700-515-137

Replaces H04-B01073



# Rear Door Hinges

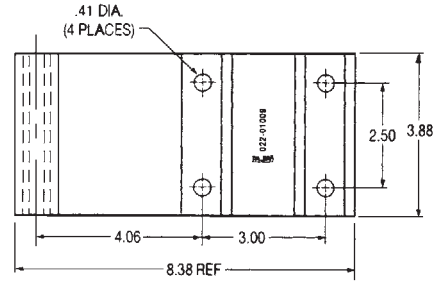
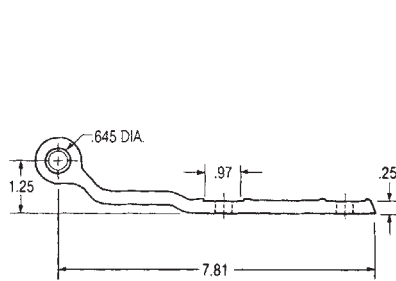

## Great Dane 4-Hole Aluminum Hinge

700-515-130

Replaces 31800904

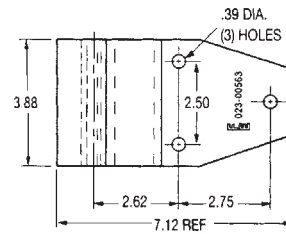
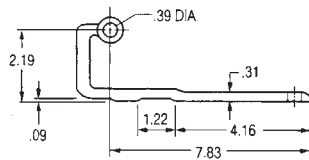

## Great Dane 3-Hole Aluminum Hinge (Dry Freight)

700-515-67

Replaces 08138

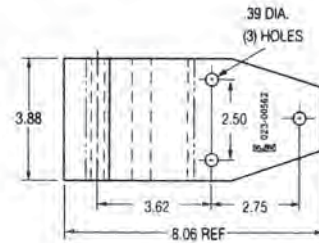
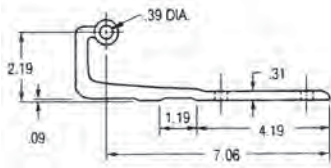

## Great Dane 3-Hole Aluminum Hinge (Reefer)

700-515-66

Replaces 08206

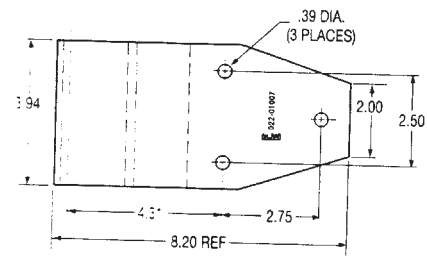
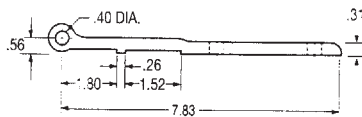

## Great Dane 3-Hole Aluminum Hinge

700-515-129

Replaces 15152

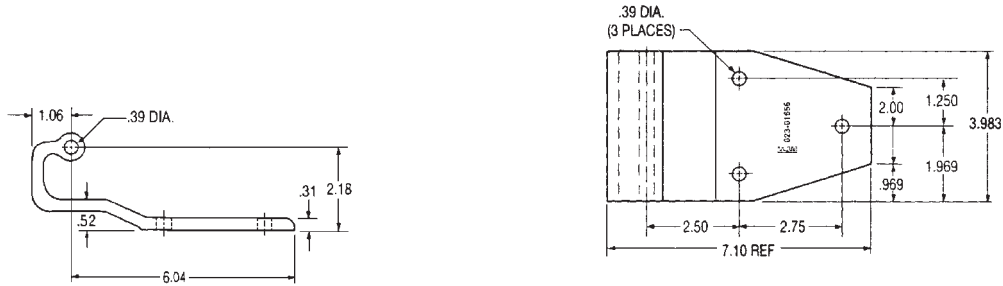

## Great Dane 3-Hole Aluminum Hinge

700-515-131

Replaces 42500813

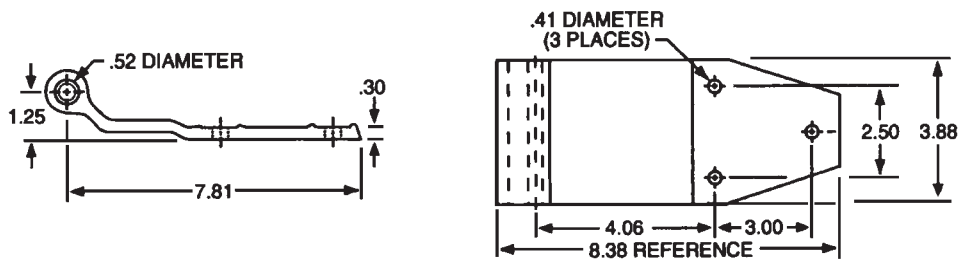

## Great Dane 3-Hole Aluminum Hinge

700-515-145

Replaces 31801018

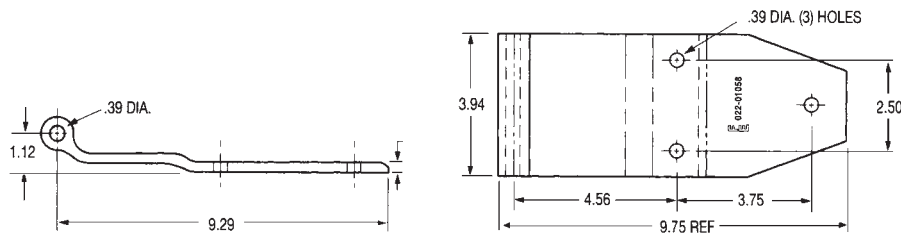

## Great Dane 3-Hole Aluminum Hinge

GD-HG01

Replaces 47563



## Highway 6-Hole Aluminum Hinge

700-515-12

Replaces 4502 / 4502-1

# Rear Door Hinges

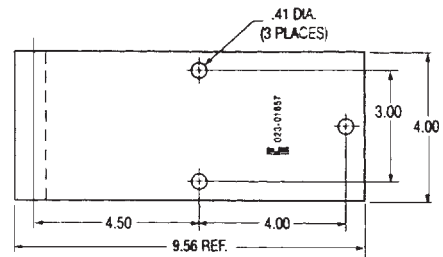
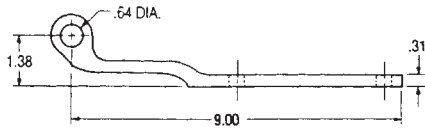

## Hyundai 3-Hole Aluminum Hinge

700-515-132

Replaces TRR 7000C-AH

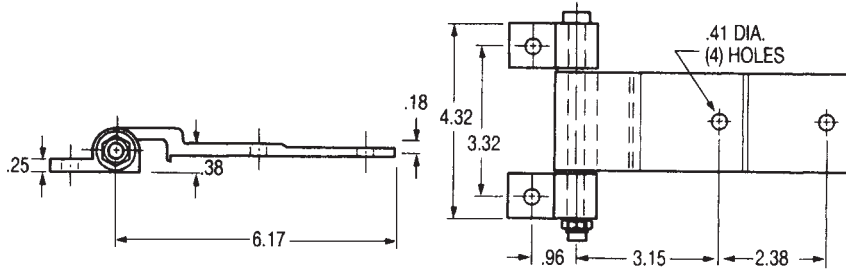

## Kentucky Hinge and Butt Assembly

700-515-148

Replaces 16600

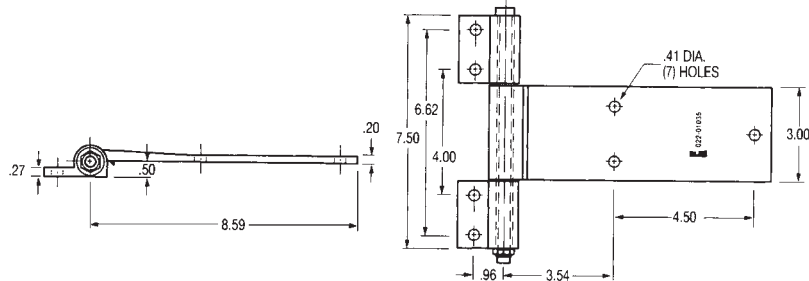

## Kentucky Hinge and Butt Assembly

700-515-153

Replaces 16396

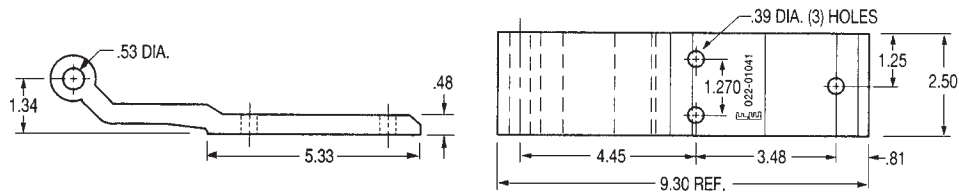

## Manac 3-Hole Aluminum Hinge

700-515-152

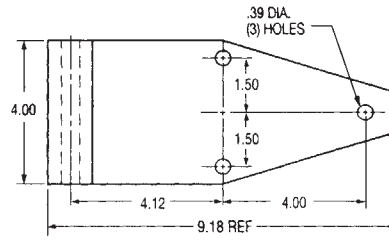
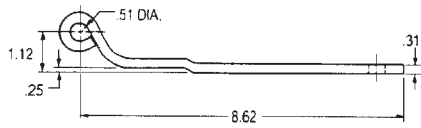

## Miller 3-Hole Steel Hinge

700-515-11

Replaces B17-0116C

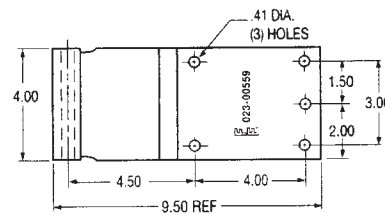
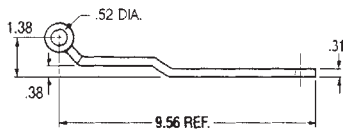

## Miner 5-Hole Steel Hinge

700-515-88

Replaces H-1060-3/1060-4

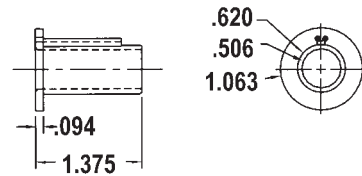
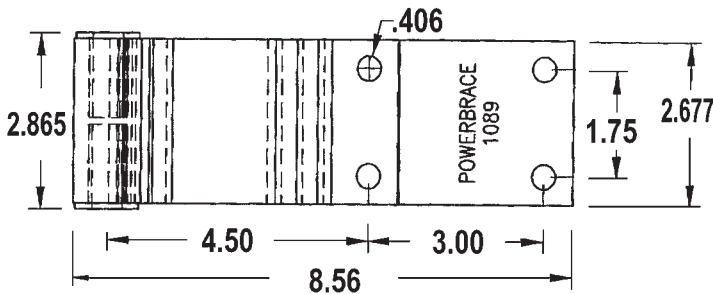

## Glide-Pro Flanged Bearing

MN-P10871A

2 per hinge

## Miner 4-Hole Aluminum Hinge (Glide-Pro)

MN-P108940A

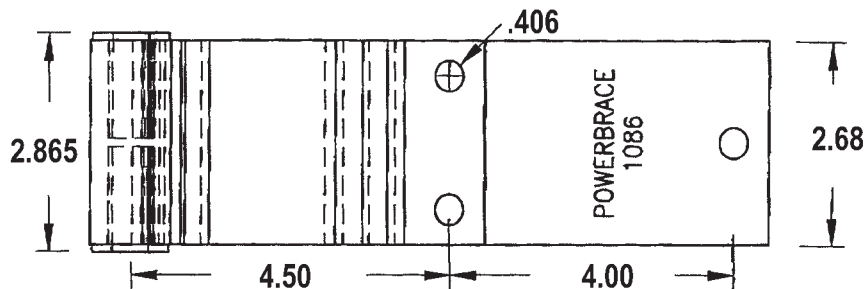

## Miner 3-Hole Aluminum Hinge (Glide-Pro)

MN-P108630A

# Rear Door Hinges

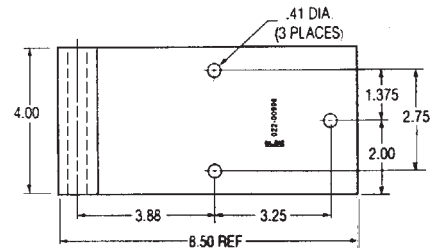
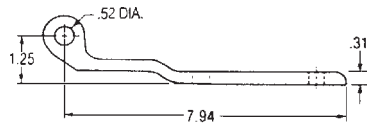

## Monon 3-Hole Aluminum Hinge

700-515-133

Replaces PC1310

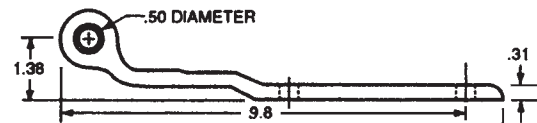
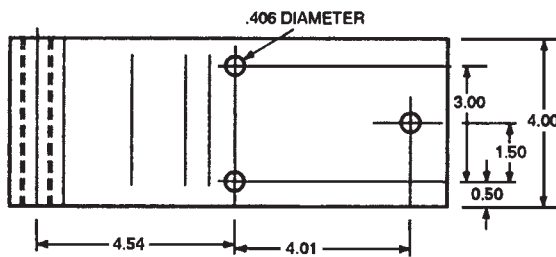

## Monon 3-Hole Aluminum Hinge

HP-HG01

Replaces E0045011

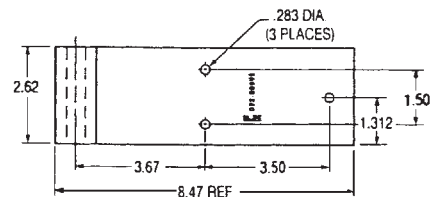
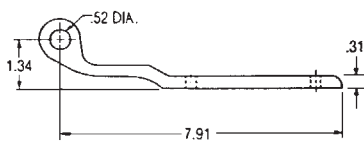

## Pines 3-Hole Aluminum Hinge

700-515-124

Replaces AE 54111 and REB-0395

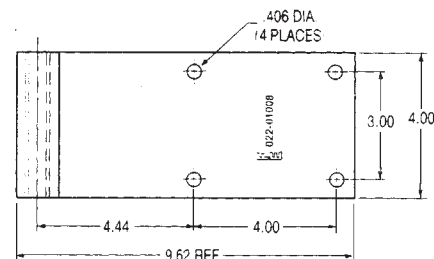
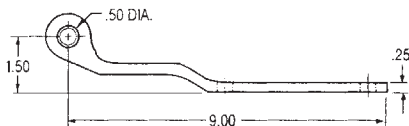

## Stoughton 4-Hole Aluminum Hinge

700-515-116

Replaces 04-08316

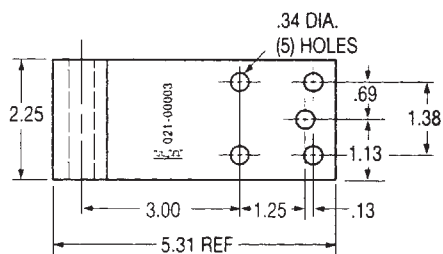
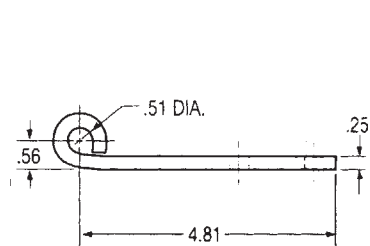

## Strick 5-Hole Steel Hinge

700-515-5

Replaces AA35F00030100

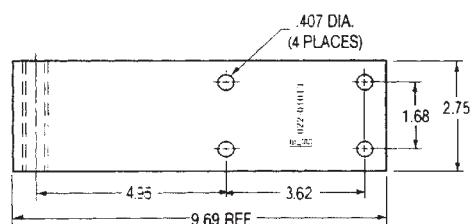
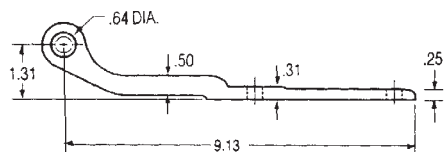

## Strick 4-Hole Aluminum Hinge

700-515-118

Replaces AA35F00230100

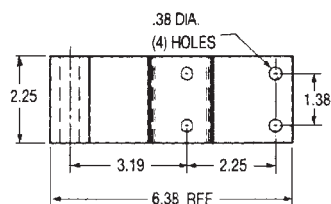
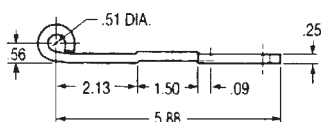

## Strick 4-Hole Steel Hinge

700-515-7

Replaces AA35F00020100

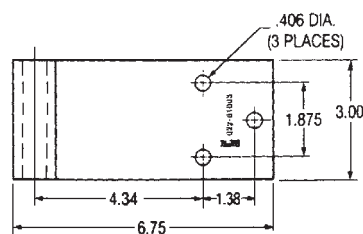
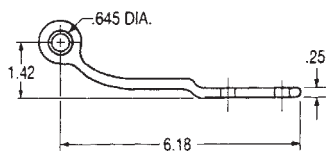

## Strick 3-Hole Aluminum Hinge

700-515-134

Replaces AA35F00100100

# Rear Door Hinges

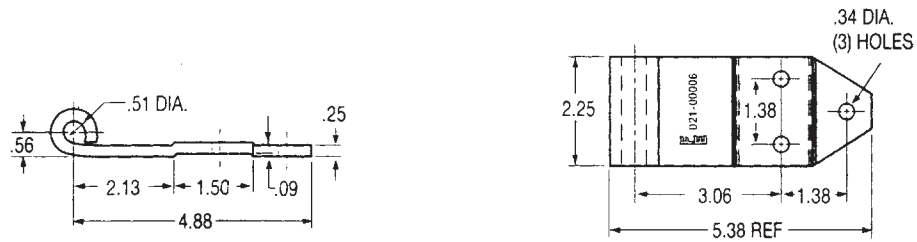

## Strick 3-Hole Steel Hinge

700-515-6

Replaces AA35F00010100

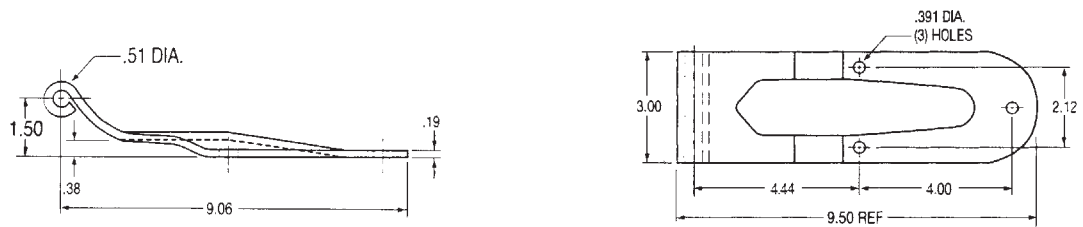

## Strick 3-Hole Steel Hinge

700-515-65

Replaces AA33C01060100

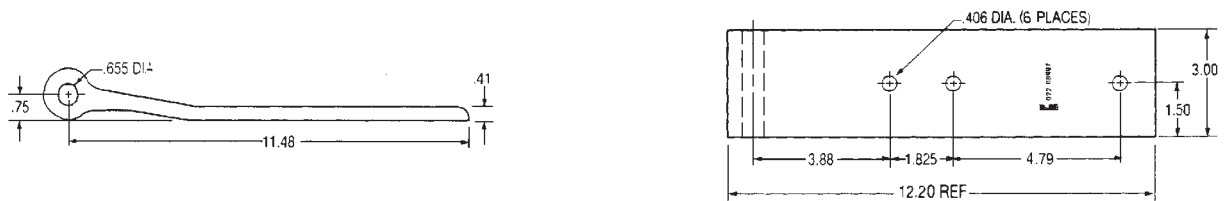

## Utility 3-Hole Aluminum Hinge

700-515-135

Replaces 3-4950-011

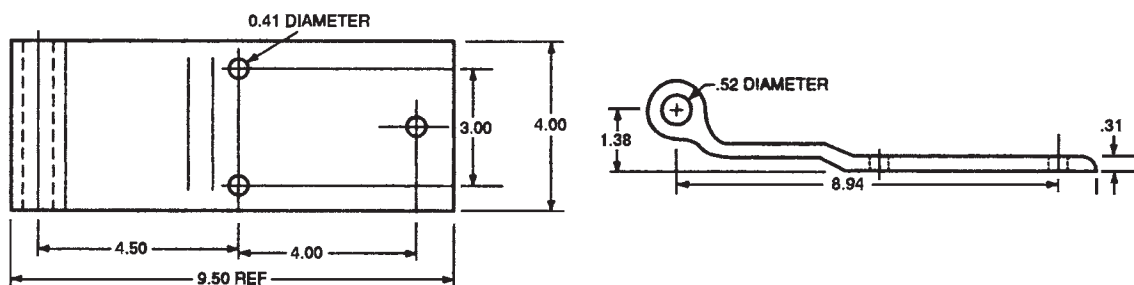

## Utility 3-Hole Aluminum Hinge

700-515-143

Replaces 3410019

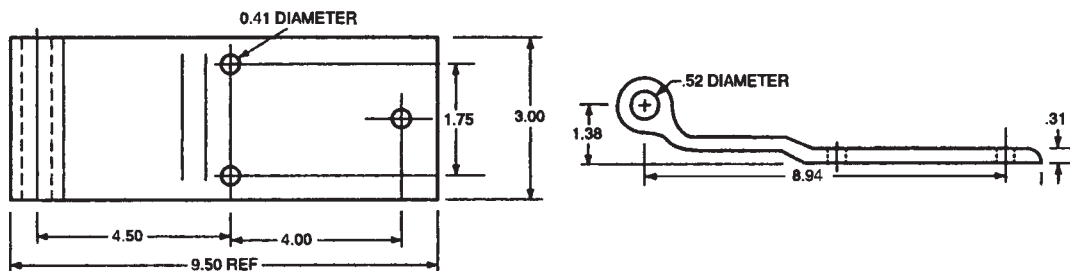

## Utility 3-Hole Aluminum Hinge UT-HG01

Replaces 3-4100-0022

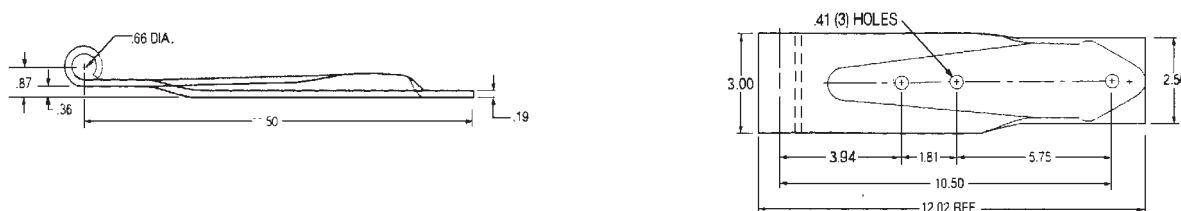

## Utility 3-Hole Steel Hinge 700-515-112

Replaces 1-4950-004



## Wabash 4-Hole Aluminum Hinge 700-515-119

Replaces 21100291

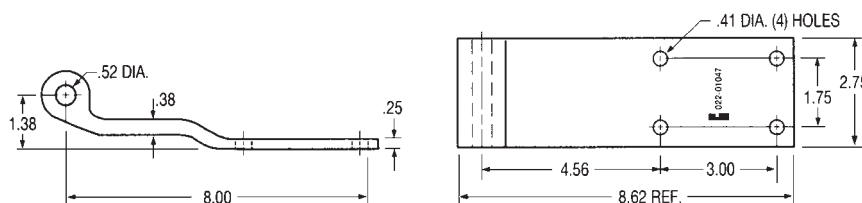

## Wabash 4-Hole Aluminum Hinge 700-515-144

Replaces 06301272



# Hinge Butts

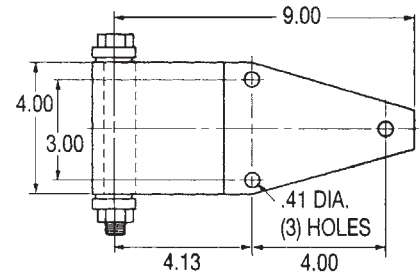
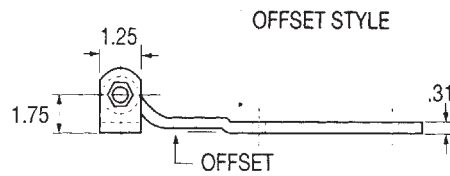

## Universal 9" Hinge and Butt Assembly 700-515-42



1-9/16"

### Trailmobile Hinge Butts

515-11-29 Steel  
515-11-29S Stn Stl  
Uses 5/8" Dia Pin



1-9/16"

### Trailmobile Hinge Butt

515-11-37  
Uses 5/8" Dia Pin

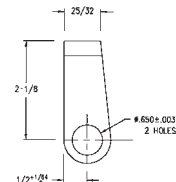

### Trailmobile Hinge Butt

6515-11-100  
Uses 5/8" Dia Pin



### Trailmobile Hinge Butt

515-11-32  
Uses 5/8" Dia Pin



1-9/16"

### Trailmobile Hinge Butt

515-11-37-2 Stn Stl  
Uses 5/8" Dia Pin



2-1/16"

### Dorsey Hinge Butt

700-515-138  
Replaces 4101483



1-11/16"

### Dorsey Hinge Butt

700-515-127



1-3/16"

### Fruehauf Hinge Butt

700-515-85  
Replaces WCF-3981-1

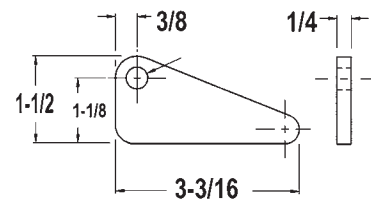

### Great Dane Hinge Butt

700-515-149  
Replaces 08137



1-5/16"

**Miner  
Hinge Butt**  
700-515-107  
Use with 700-515-88

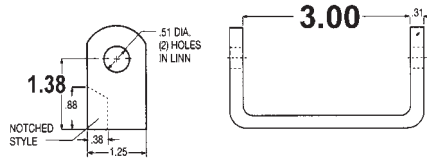

**Wabash  
Hinge Butt**  
WA-HB01  
Replaces 06300297



**Trailmobile  
Hinge Pin**  
515-12-23  
5/8" Dia X 4-3/8"



**Trailmobile  
Hinge Pin**  
515-12-13  
5/8" Dia X 4-1/8"

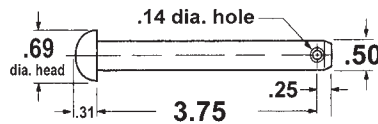

**Dorsey  
Hinge Pin**  
DO-HP01  
1/2" Dia X 4"  
Replaces 5248614



**Fruehauf / Miner  
Hinge Pin**  
700-515-84  
1/2" Dia X 5-1/4"; replaces  
WCE-7812-1 & HP-1054-4



**Great Dane  
Hinge Pin**  
700-515-108  
3/8" Dia X 5"  
Replaces 44573



**Utility  
Hinge Pin**  
700-515-113  
5/8" Dia X 4-1/2"  
Replaces 3-6101-08



**Universal  
Hinge Pin**  
515-12-12-NS  
1/2" Dia X 4"

# Door Hold Backs



**Trailmobile  
Hold Back Kit**  
515-A9-53

Kit Components:

Item	Part No.	Description	Qty
1	515-9-61	Hold Back	2
2	515-9-71	Chain Link	2
3	515-9-70	Connector Link	2
4	50-18P-23	Rivet	4

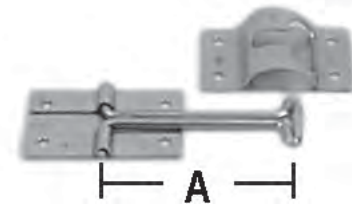

**T-Slot**

700-532-4

A = 4"

700-532-5

A = 6"



**Bracket & Chain Kit**  
700-515-141



**Spring-Loaded Hold Back**  
700-515-162



**Chain & Snap**  
700-515-33

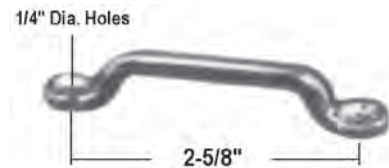

**Handle**  
700-532-7

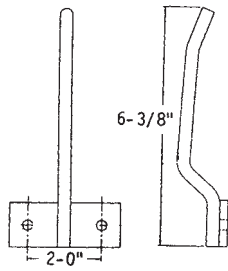

**Hold Back Hook**  
515-9-78B

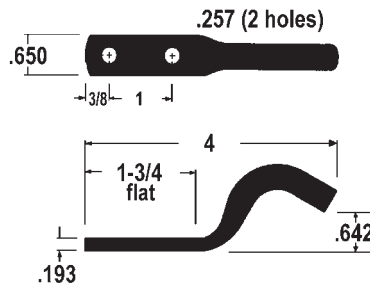

**Hold Back Hook**  
515-9-81

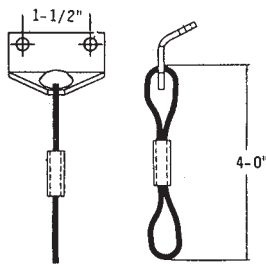

**Hold Back Loop**  
515-9-78A



**Rubber Door Stop**  
700-515-109



**Snap Hook**  
700-515-105  
7/16" X 3-1/8"



**Snap Hook**  
700-515-87  
1/2" X 3-7/8"



**Retaining Clip**  
522-23-7



**Tie Ring**  
700-515-86

# Rear Door Locks

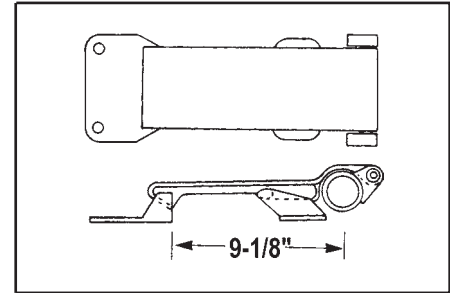
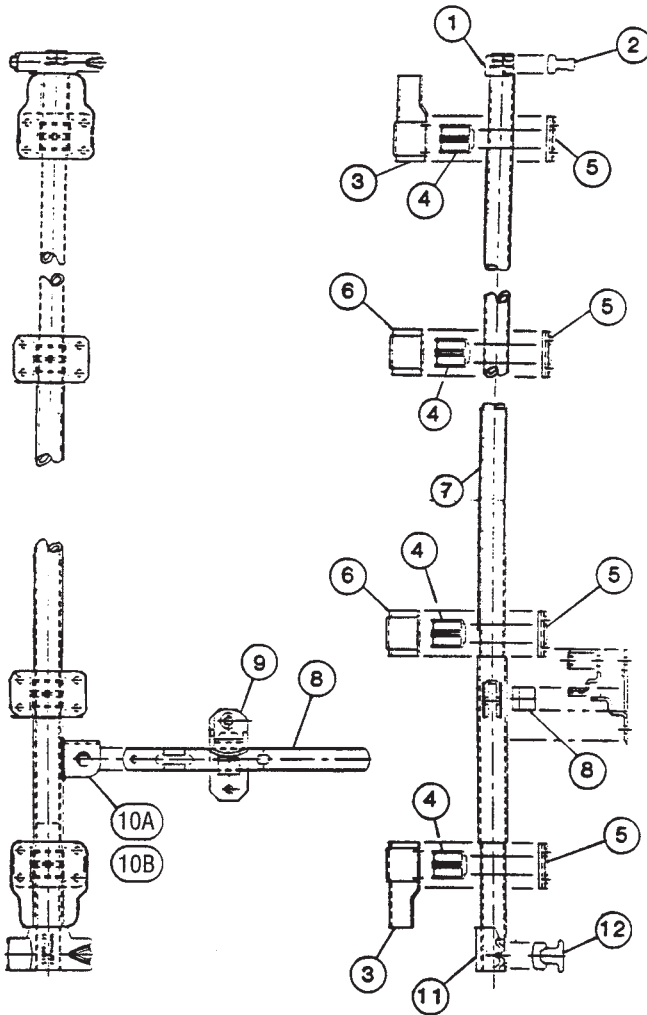

**Trailmobile  
Mid-Cam Lock**  
700-532-15

**Inside Release**  
9532-A2-11

**Trailmobile New Style  
Rear Door Lock Kit**  
700-532-13  
Kit Components:

Item	Part No.	Description	Qty
1	532-5-42	Top Cam	1
2	532-9-52	Top Cam Keeper	1
3	532-6-32	Top and Bottom Bearing Cover	2
4	532-6-33	Top and Bottom Cover Bushing	4
5	532-6-31	Bearing Cover Back Plate	4
6	532-6-30	Lock Rod Bearing Cover	2
7	700-532-9	Lock Rod Pipe	0
8	532-1-46	Lock Handle	1
9	532-A2-21	Latch Assembly	1
10A	700-532-14L	Roadside Handle Bracket and Sleeve	1
10B	700-532-14R	Curbside Handle Bracket and Sleeve	1
11	532-5-43	Bottom Cam	1
12	532-9-54	Bottom Cam Keeper	1

**Note:**

For stainless steel cam keepers,  
order:

532-9-52-1 Top Cam Keeper  
532-9-54-1 Bottom Cam Keeper

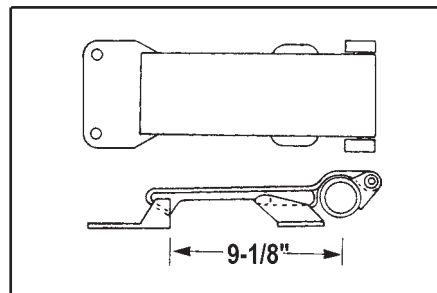
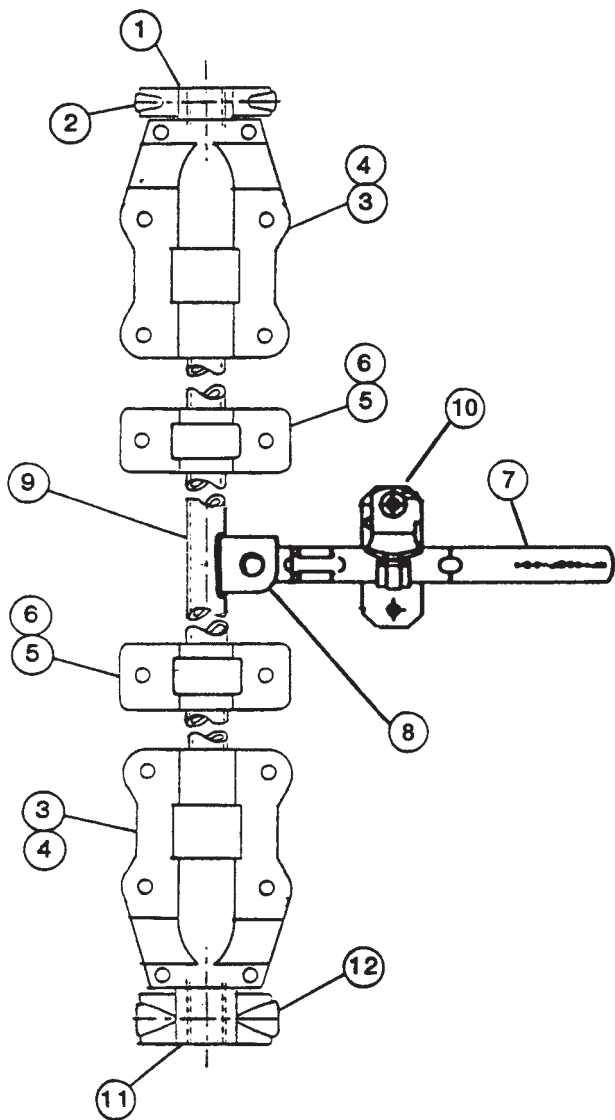

**Trailmobile  
Mid-Cam Lock**  
700-532-15

**Trailmobile  
Rear Door Lock Kit**  
700-532-8  
Kit Components:

Item	Part No.	Description	Qty
1	532-5-42	Top Cam	1
2	532-9-52	Top Cam Keeper	1
3	532-6-27	Top and Bottom Bearing Cover	2
4	532-6-28	Top and Bottom Back Plate	2
5	532-6-25	Lock Rod Bearing Cover	2
6	532-6-26	Bearing Cover Back Plate	2
7	532-1-46	Lock Handle	1
8	532-18-12	Handle Mounting Bracket	1
9	700-532-9	Lock Rod Pipe	0
10	532-A2-21	Latch Assembly	1
11	532-5-43	Bottom Cam	1
12	532-9-54	Bottom Cam Keeper	1

**Note:**

For stainless steel cam keepers, order:

- 532-9-52-1 Top Cam Keeper
- 532-9-54-1 Bottom Cam Keeper

# Rear Door Locks

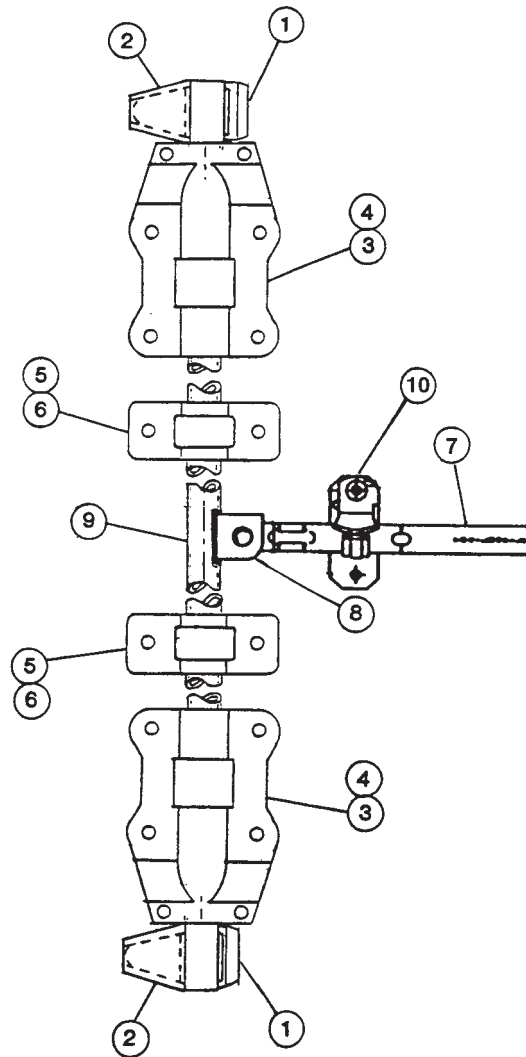

## Trailmobile Rear Door Lock Kit

700-532-2

Kit Components:

Item	Part No.	Description	Qty
1	532-5-22	Top and Bottom Cam	2
2	532-9-41	Top and Bottom Cam Keeper	2
3	532-6-27	Top and Bottom Bearing Cover	2
4	532-6-28	Top and Bottom Back Plate	2
5	532-6-25	Lock Rod Bearing Cover	2
6	532-6-26	Bearing Cover Back Plate	2
7	532-1-40	Lock Handle	1
8	532-18-5A	Handle Mounting Bracket	1
9	700-532-9	Lock Rod Pipe	0
10	532-A2-14A	Latch Assembly	1

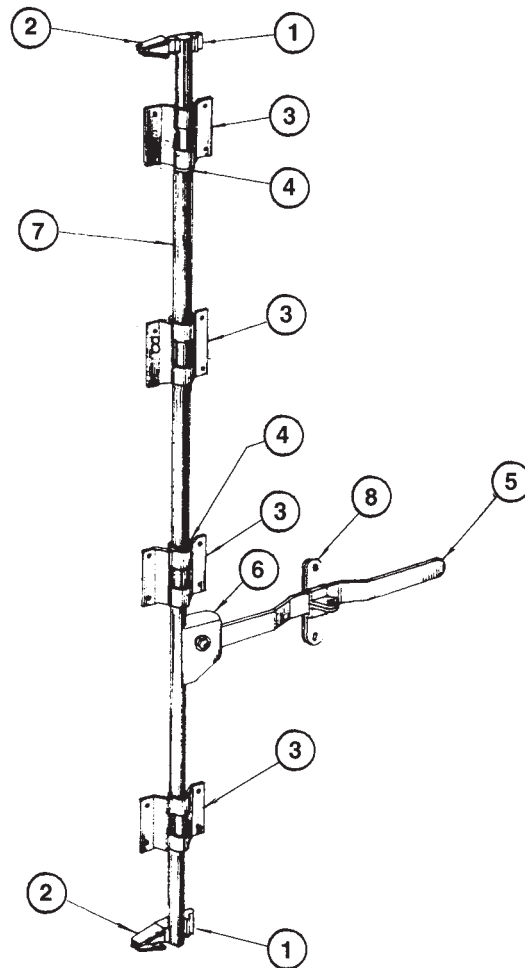

## Trailmobile "A" & "D" Model Rear Door Lock Kit

700-532-1

Kit Components:

Item	Part No.	Description	Qty
1	532-5-22	Top and Bottom Cam	2
2	532-9-41	Top and Bottom Cam Keeper	2
3	532-6-21	Lock Rod Bearing Cover	4
4	50-3C-14	Lock Rod Bearing Collar	2
5	532-1-40	Lock Handle	1
6	532-18-5A	Handle Mounting Bracket	1
7	700-532-9	Lock Rod Pipe	0
8	532-A2-14A	Latch Assembly	1



# Rear Door Locks

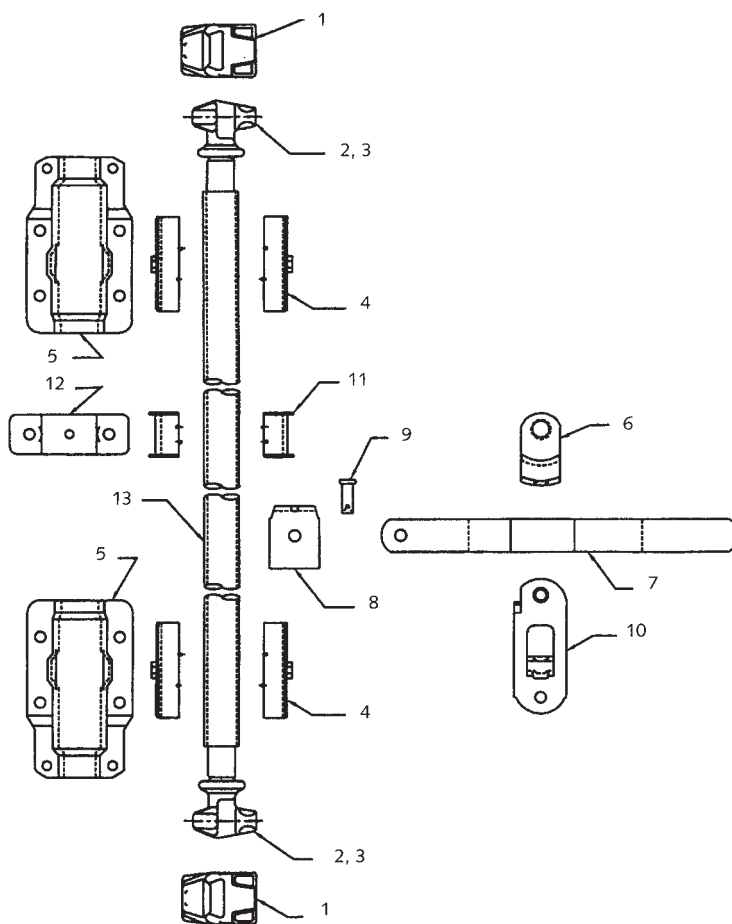

## Miner Rear Door Lock Kit

**MN-DL-BU**

Kit Components:

Note:

For narrow header, order:

MN-4140 Top and Bottom Cam  
Keeper  
(Order 2)

MN-4141 Roadside Top/Curbside  
Bottom Cam

MN-4142 Curbside Top/Roadside  
Bottom Cam

Item	Part No.	Description	Qty
1	MN-1064	Top and Bottom Cam Keeper	2
2	MN-4043	Roadside Top/Curbside Bottom Cam	1
3	MN-4044	Curbside Top/Roadside Bottom Cam	1
4	MN-4042	Top and Bottom Cover Bushing	4
5	MN-4207	Top and Bottom Bearing Cover	2
6	MN-4012	Seal Pin	1
7	MN-4090	Lock Handle	1
8	MN-4208	Handle Mounting Bracket	1
9	MN-4049	Rivet	1
10	MN-4011	Seal Plate	1
11	MN-4006	Lock Rod Bushing	2
12	MN-4005	Lock Rod Guide	1
13	700-532-9	Lock Rod Pipe	0

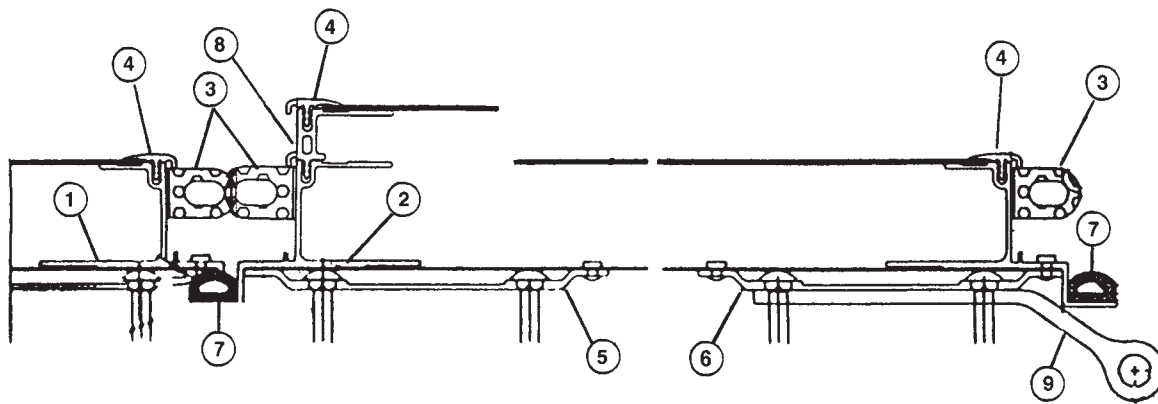

## Trailmobile Nordic 145

Item	Part No.	Description	Quantity Roadside Door	Quantity Curbside Door	Door Thickness
1	90-4-2216-0-120	Frame Member	1	N/A	2" & 3"
2	90-4-2225-0-165	Frame Member	2	3	
3	90-4-2236-0-114	Inner Seal	3	3	
4	90-4-2129-0-114	Retainer Clip	3	3	
5	90-4-2226-0-120	Lock Rod Spacer	1	1	
6	90-4-2226-0-120	Hinge Spacer (4-Hinge)	1	1	
7	90-4-1962-0-120	Outer Seal	2	3	
8	90-4-2238-0-114	1" Spacer	3	3	3"
9	See OV Catalog	Hinge	4 or 5	4 or 5	2" & 3"

# Reefer Rear Doors



## TRAILMOBILE NORDIC 145 DOORS

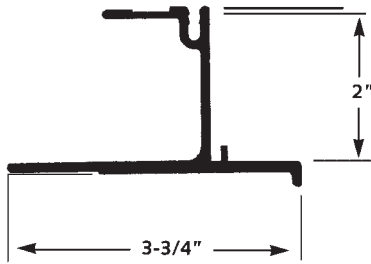

**Frame Member**  
90-4-2216-0-120  
Aluminum

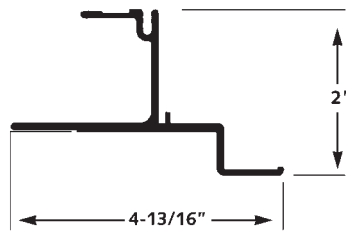

**Frame Member**  
90-4-2225-0-165  
Aluminum

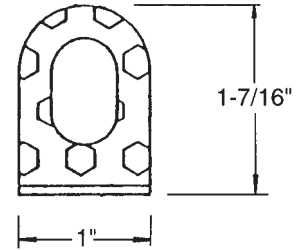

**Inner Seal**  
90-4-2236-0-114



**Retainer Clip**  
90-4-2129-0-114  
Plastic

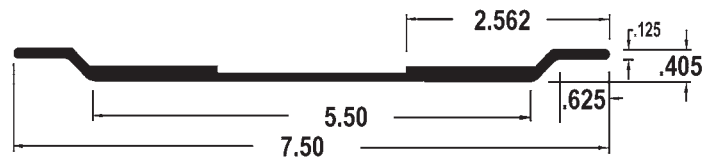

**Lock Rod and Hinge Spacer**  
90-4-2226-0-120 10'-0"  
Aluminum

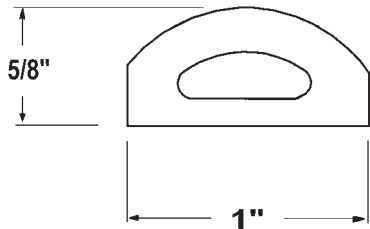

**Outer Seal**  
90-4-1962-0-120

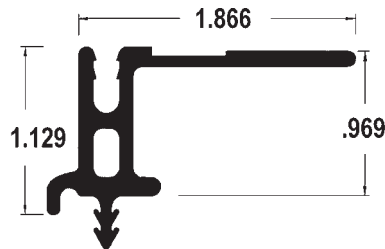

**1" Spacer**  
90-4-2238-0-114

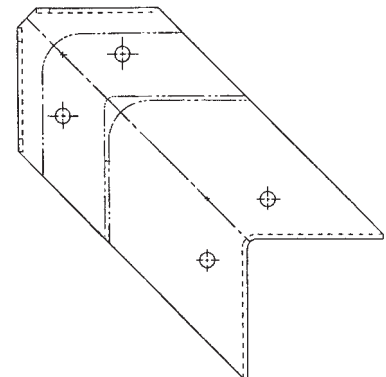

**Corner Stamping**  
515-16-45  
Aluminum

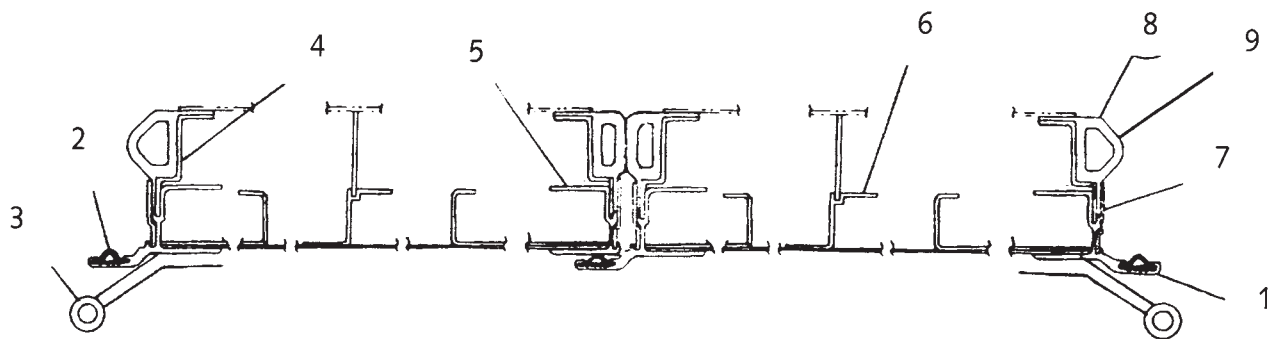

## Trailmobile Concept II

Item	Part No.	Description	Quantity Roadside Door	Quantity Curbside Door
1	90-4-1726-0-160	Seal Retainer	2	2
2	90-4-828-0-120	Outer Seal	2	3
3	See OV Catalog	Hinge	4 or 5	4 or 5
4	90-4-1728-0-108	Frame Member	3	3
5	90-4-1727-0-120	Frame Member	1	N/A
6	90-4-1714-0-109	Hinge Support	3	3
7	90-4-1730-0-154	Inner Seal Retainer	3	3
8	90-4-1729-0-120	Vertical Inner Seal	2	2
9	90-4-1729-0-50	Horizontal Inner Seal	2	2

# Reefer Rear Doors



## TRAILMOBILE CONCEPT II DOORS

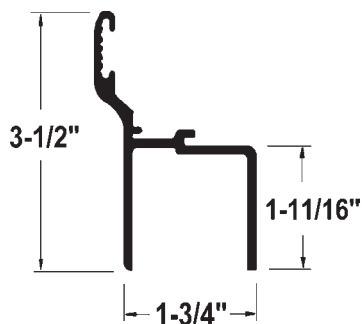

**Seal Retainer**  
90-4-1726-0-160  
Aluminum

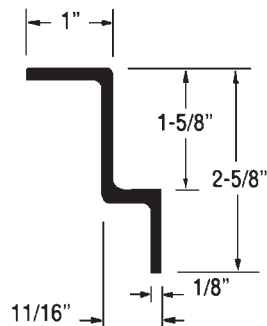

**Frame Member**  
90-4-1728-0-108  
Plastic

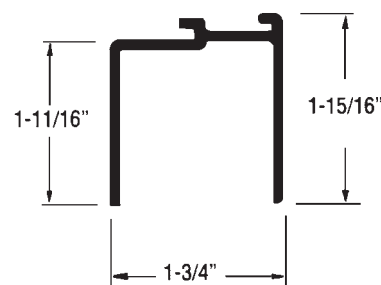

**Frame Member**  
90-4-1727-0-104  
Aluminum

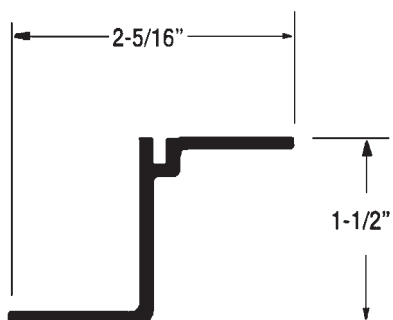

**Hinge Support**  
90-4-1714-0-109  
Aluminum

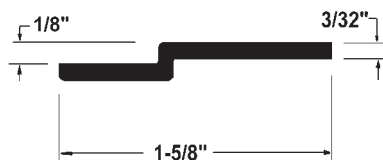

**Inner Seal Retainer**  
90-4-1730-0-154  
Aluminum

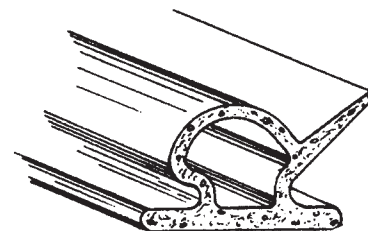

**Outer Seal**  
90-4-828-0-120

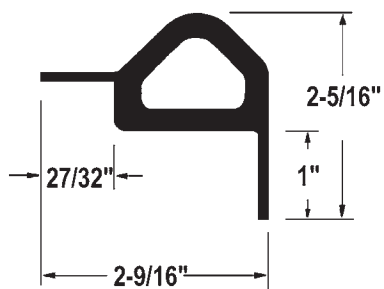

**Inner Seal**  
90-4-1729-0-120 120"  
90-4-1729-0-50 50"

## TRAILMOBILE NORDIC 145 and CONCEPT II DOORS

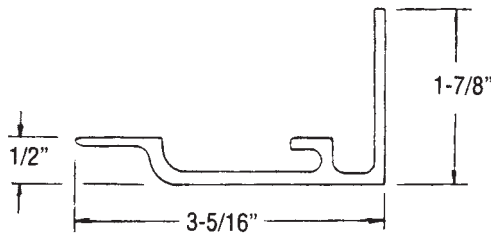

**Rear Header Slam Block**  
90-4-1776-0-98  
Aluminum

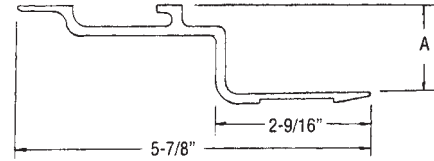

**Rear Corner Post Slam Block**  
Aluminum

Part No.	Side Insulation Thickness	A
90-4-1900-0-112	1-1/2"	0
90-4-1936-0-112	2"	0.462
90-4-1937-0-112	2-1/2"	0.962
90-4-1938-0-112	3"	1.462
90-4-1939-0-112	4"	2.462

## TRAILMOBILE OLD STYLE DOORS

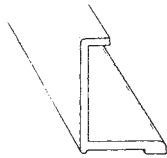

**Insulator Channel**  
90-4-1292-0-103  
Plastic

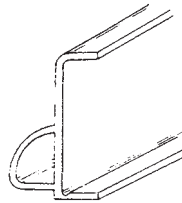

**Insulator Seal**  
90-4-1407-0-120  
Rubber

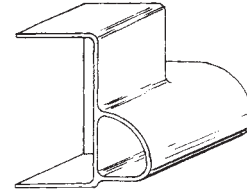

**Insulator Corner Seal**  
515-14-113  
Rubber

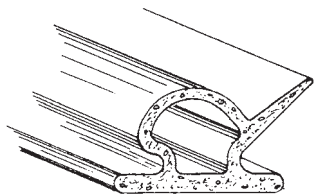

**Outside Seal**  
90-4-828-0-120

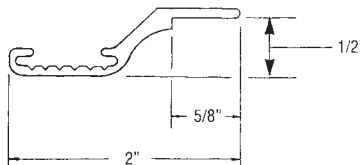

**Seal Retainer**  
90-4-1635-0-160  
Aluminum

# Dry Freight Side Doors



## DRY FREIGHT UNIVERSAL SIDE DOOR KITS ("O" MODEL)

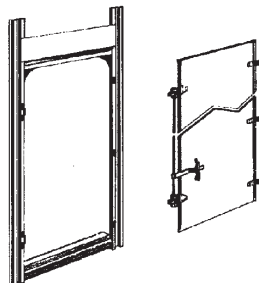

### 82-5/16" High Opening

700-516-6-96-36

Pre-Painted White Door

Unique Kit Components:

Part No.	Description	Qty in Kit
700-516-4-96	Steel Frame Opening Size: 46-5/16" X 82-5/16"	1
700-515-4-96-36	1/2" Plymetal Blank with Dual Durometer Seals	1

### 92-5/16" High Opening

700-516-6-108-36

Pre-Painted White Door

Unique Kit Components:

Part No.	Description	Qty in Kit
700-516-4-108	Steel Frame Opening Size: 46-5/16" X 92-5/16"	1
700-515-4-108-36	1/2" Plymetal Blank with Dual Durometer Seals	1

Common Kit Components:

Part No.	Description	Qty in Kit
---	Header Reinforcement (24" X 122")	1
516-2-46-1	Hinge	3
516-24-11	Hinge Butt	3
516-25-5	Hinge Pin	3
532-A2-20L	Latch Assembly L.H.	1
532-A2-20R	Latch Assembly R.H.	1
532-1-43	Lock Handle	1
532-16-13	Lock Keeper	2
532-5-40	Cam	2
532-6-24-1	Bearing Plate	2

Note: Bottom Rail Reinforcements are not included in kits

## DRY FREIGHT UNIVERSAL SIDE DOOR KIT ("A" & "D" MODELS)

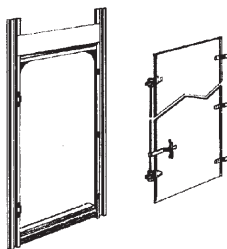

### 85-5/16" High Opening

700-516-1-36

Pre-Painted White Door

Kit Components:

Part No.	Description	Qty in Kit
700-516-2	Steel Frame (Opening Size 44" X 85-5/16")	1
700-515-1-108-36	1/2" Plymetal Blank (with Dual Durometer Seals)	1
516-2-46-1	Hinge	3
516-24-11	Hinge Butt	3
516-25-5	Hinge Pin	3
532-A2-20L	Latch Assembly L.H.	1
532-A2-20R	Latch Assembly R.H.	1
532-1-43	Lock Handle	1
532-16-13	Lock Keeper	2
532-5-40	Cam	2
532-6-24-1	Bearing Plate	2

Note: Bottom Rail Reinforcements are not included in kit

### SIDE DOOR POSTS

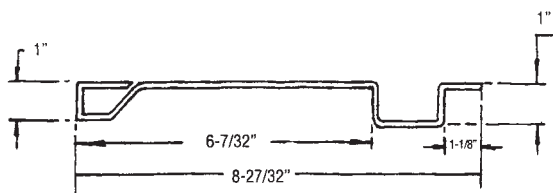

#### "O" Model

90-4-1109-0-130 130"  
10 Ga. Steel

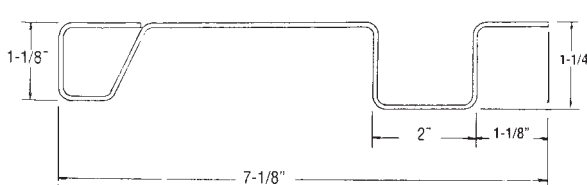

#### "A" & "D" Models

90-4-527-0-108 108-13/16"  
10 Ga. Steel



# Dry Freight Side Doors

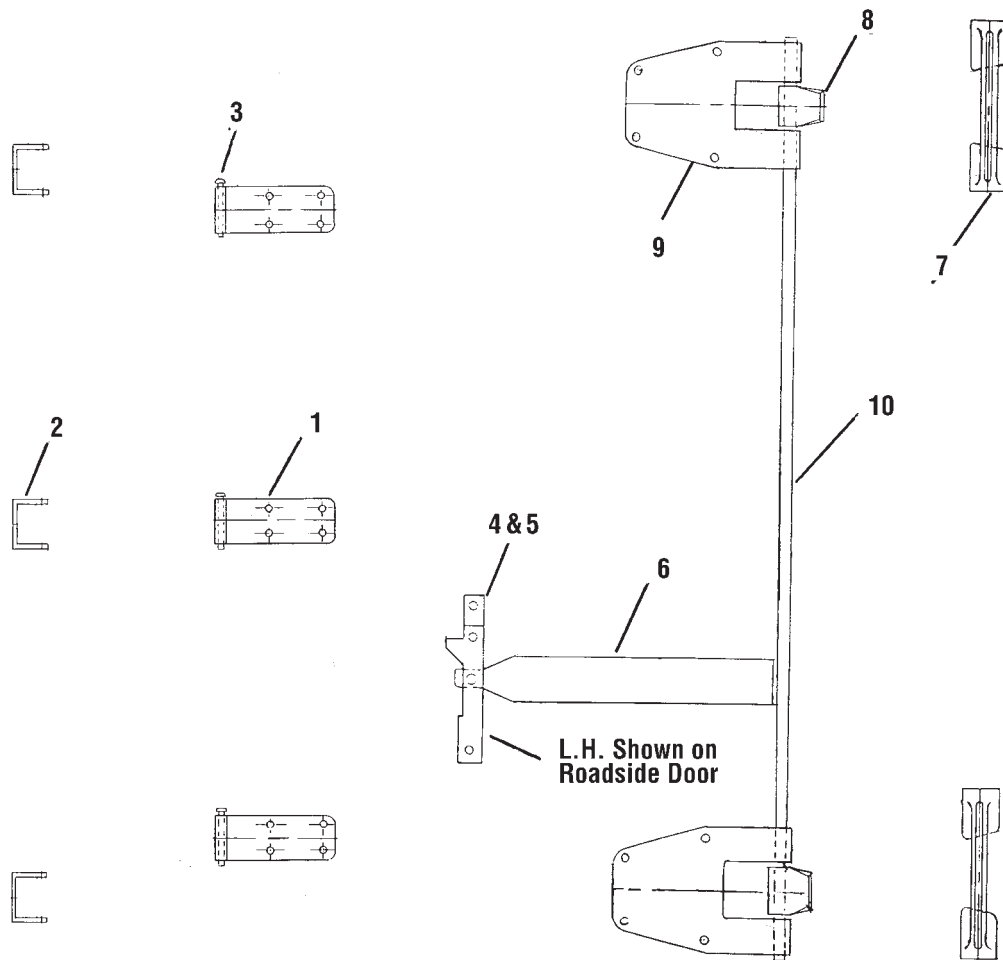

## Dry Freight Side Door Hardware Kit 700-532-6

### Kit Components:

Item	Part No.	Description	Qty in Kit
1	516-2-46-1	Hinge	3
2	516-24-11	Hinge Butt	3
3	516-25-5	Hinge Pin	3
4	532-A2-20L	Latch Assembly L.H.	1
5	532-A2-20R	Latch Assembly R.H.	1
6	532-1-43	Lock Handle	1
7	532-16-13	Lock Keeper	2
8	532-5-40	Cam	2
9	532-6-24-1	Bearing Plate	2
10	---	1/2" I.D. Pipe	0

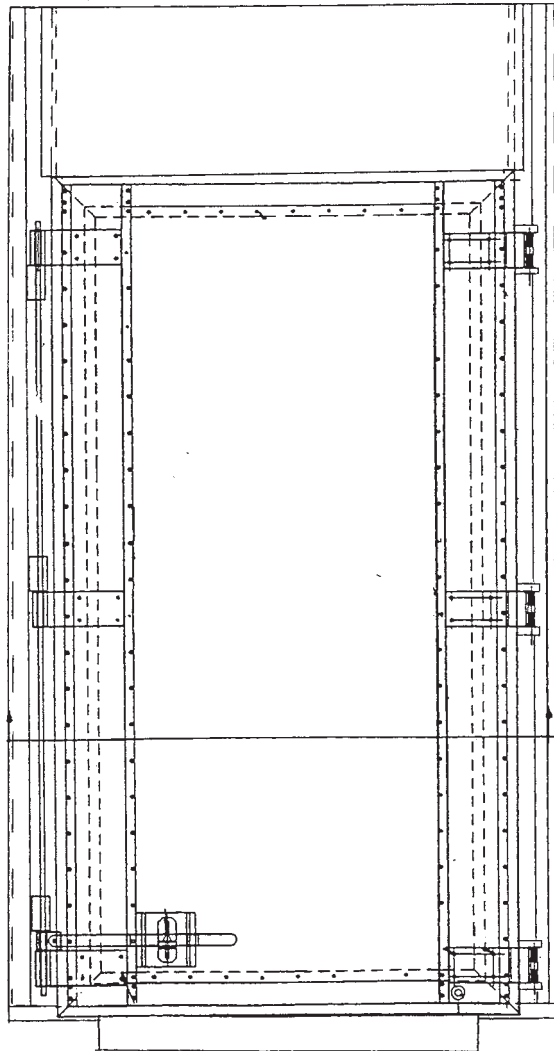

## Reefer Universal Side Door Kit

700-516-13

2" & 3" Side Insulation Thickness

Door Thickness - 2"

Clear Opening - 46-5/16" Wide X 84" High

Note:

Kit includes Frame, Door, Locking Hardware, Door Jams, Header, and Bottom Rail Reinforcements.

104-1/4" Post Height; Aluminum Construction.

Door kit is set up for Right Hand or Left Hand Swing.

# Reefer Side Doors

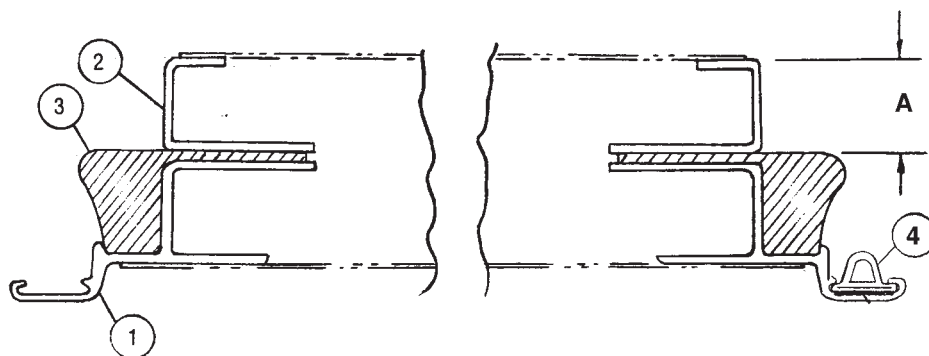

## Reefer "O" Model Side Door

Item	Part No.	Description	Qty Per Door
1	90-4-1782-0-100	Seal Retainer	2
2	See Chart Below	Frame Member	3
3	90-4-1788-0-114	Inner Seal	3
4	90--4-828-0-120	Outer Seal	3

Door Insulation Thickness	Item # 2 Above	A
2"	90-4-1784-0-114	5/8"
2-1/2"	90-4-1785-0-114	1-1/8"

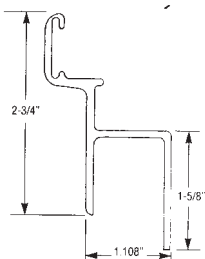

**Seal Retainer**  
90-4-1782-0-100  
Aluminum

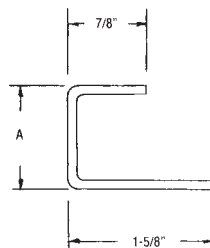

**Frame Member**  
Plastic

Part No	A
90-4-1784-0-114	5/8"
90-4-1785-0-114	1-1/8"

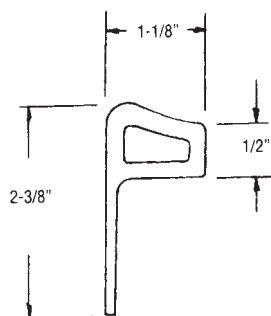

**Inner Seal**  
90-4-1788-0-114

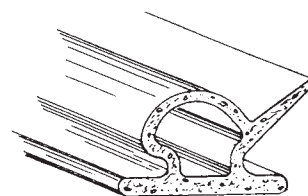

**Outer Seal**  
90-4-828-0-120

## Door Post and Header Slams

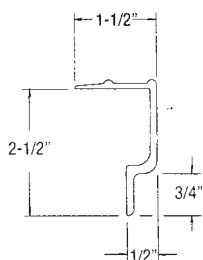

**90-4-1584-0-100**  
For 2-1/2" Wall; Aluminum

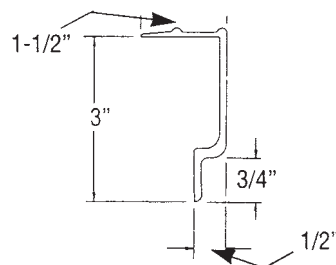

**90-4-1585-0-100**  
For 3" Wall; Aluminum

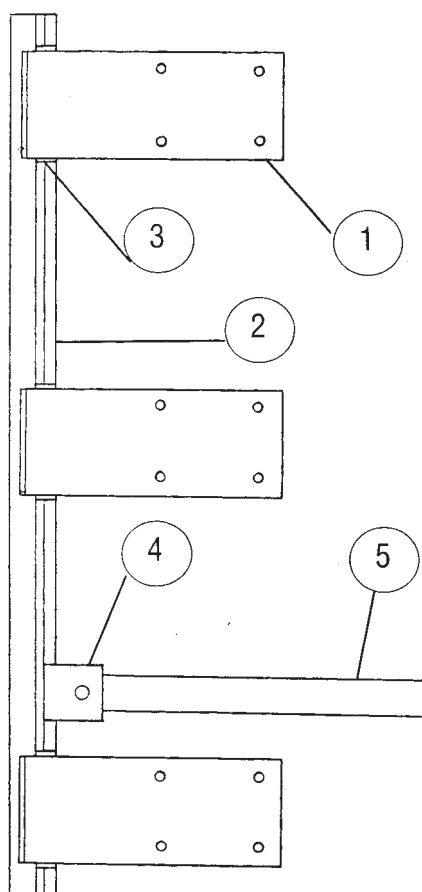

Extruded  
Aluminum

## Side Door Locks and Hardware

Item	Part No.	Description
1	532-6-29	Bearing Plate
2	90-4-1760-0-85	Lock Cam 85"
3	516-25-6	Pin
4	532-1-47	Handle Retainer
5	532-1-48	Lock Handle

# Reefer Side Doors

## SIDE DOOR LOCKS and HARDWARE

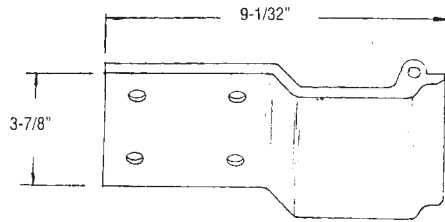

**Bearing Plate**  
532-6-29

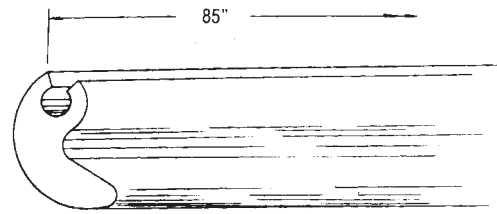

**Lock Cam**  
90-4-1760-0-85

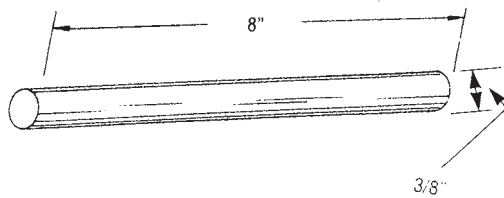

**Bearing Plate Hinge Pin**  
516-25-6

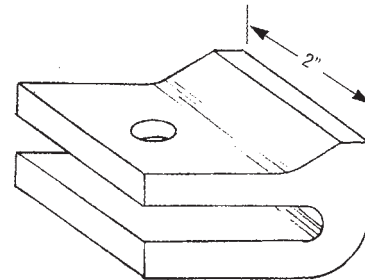

**Handle Retainer**  
532-1-47

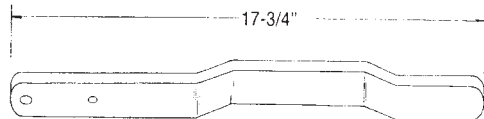

**Lock Handle**  
532-1-48

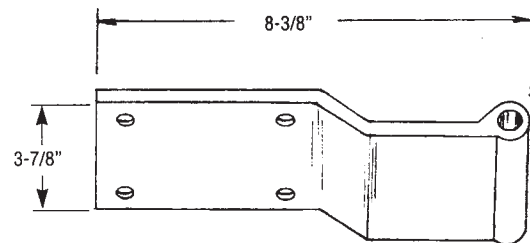

**Door Hinge**  
516-2-47  
Aluminum

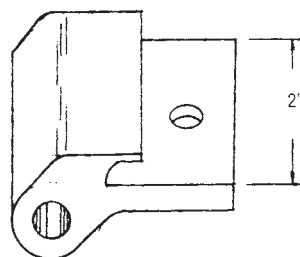

**Hinge Butt**  
516-24-12  
Aluminum

## TODCO 3/4" DRY FREIGHT DOORS Tongue & Groove

### Todco Door Assemblies with Track and Operator (Primer or White Paint)

With:  
TO-49702 Horizontal Track  
TO-49014 Vertical Track  
TO-59292 Operator

Door Size	90" X 90"	90" X 100"	98" X 100"	98" X 105"
Part No.	TO-99611-1	TO-99610-1	TO-99836-1	TO-99837-1
	TO-99611-1-PPW	TO-99610-1-PPW		TO-99837-1-PPW

### Todco Door Assemblies without Track or Operator (Primer or White Paint)

Door Size	90" X 90"	90" X 100"	98" X 100"	98" X 105"
Part No.	TO-99611-2	TO-99610-2	TO-99836-2	TO-99837-2
	TO-99611-2-PPW	TO-99610-2-PPW		TO-99837-2-PPW

### Generic Door Assemblies without Track or Operator (Primer)

Door Size	90" X 90"	90" X 100"	98" X 100"	98" X 105"
Part No.	GT-90X90LTO	GT-90X100LTO	GT-98X100LTO	GT-98X105LTO

**Track and Operator Kit**  
TO-50035  
For 107" Door

**ABF-Spec Door Assembly  
(without Track or Operator)**  
TO-99ABF1-4  
94" X 109"

# Todco Roll-Up Doors



## REPLACEMENT TODCO 3/4" DOOR PANELS Tongue & Groove

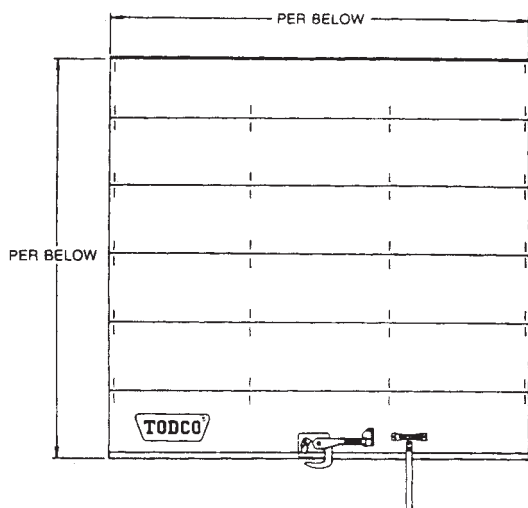

### Door Panel Configuration

Height	90"	100"	105"
Top Panel	(1) 15"	(1) 18"	(1) 15"
Intermediate Panels	(4) 15"	(3) 15" (2) 11"	(5) 15"
Bottom Panel	(1) 15"	(1) 15"	(1) 15"

### Top Panel

Todco Part No.	Panel Size	Finish	Generic Part No.
TO-29013-15X96	15" X 98"	Primer	---

### Intermediate Panels

Todco Part No.	Panel Size	Finish	Generic Part No.
TO-29014-11X96	11" X 98"	Primer	GT-INT-11X98
TO-29018-11X96		White Aluminum	---
TO-29014-11.5X96	11.5" X 98"	Primer	---
TO-29014-12X96	12" X 98"	Primer	GT-INT-12X98
TO-29018-12X96		White Aluminum	---
TO-29014-12X96PPW		White Paint	---
TO-29014-13X96	13" X 98"	Primer	---
TO-29018-13X96		White Aluminum	---
TO-29014-14X96	14" X 98"	Primer	---
TO-29018-15X90	15" X 90"	White Aluminum	---
TO-29014-15X96	15" X 98"	Primer	GT-INT-15X98
TO-29018-15X96		White Aluminum	---
TO-29014-15X96PPW		White Paint	---
TO-29889-16X98 (ABF Spec)	16" X 98"	Primer	---
TO-29014-18X96	18" X 98"	Primer	---

## REPLACEMENT TODCO 3/4" DOOR PANELS

### Tongue & Groove

### Bottom Panels

With:

- TO-61191 Bottom Angle
- TO-80840-1 Bottom Seal
- TO-61401 Lift Handle
- TO-61204 Cable Brackets
- TO-61352 Bottom Fixtures
- 80844 Pull Strap

Without:

- Lock

Todco Part No.	Panel Size	Finish	Generic Part No.
TO-29016-11X90	11" X 90"	Primer	---
TO-29016-11X96	11" X 98"	Primer	GT-BOT-1-11X98
TO-29020-11X96		White Aluminum	---
TO-29016-12X90	12" X 90"	Primer	---
TO-29016-12X96	12" X 98"	Primer	GT-BOT-1-12X98
TO-29020-12X96		White Aluminum	---
TO-29016-12X96PPW		White Paint	---
TO-29016-13X90	13" X 90"	Primer	---
TO-29016-13X96	13" X 98"	Primer	---
TO-29020-13X96		White Aluminum	---
TO-29016-14X96	14" X 98"	Primer	---
TO-29016-15X90	15" X 90"	Primer	GT-BOT-1-15X90
TO-29016-15X90PPW		White Paint	---
TO-29016-15X96	15" X 98"	Primer	GT-BOT-1-15X98
TO-29020-15X96		White Aluminum	---
TO-29016-15X96PPW		White Paint	---
TO-29890-2-16X96ABF (ABF Spec w/ Lock Assy)	16" X 96"	Primer	---
TO-29016-16X96	16" X 98"	Primer	---
TO-29016-18X96	18" X 98"	Primer	---



# Todco Roll-Up Doors

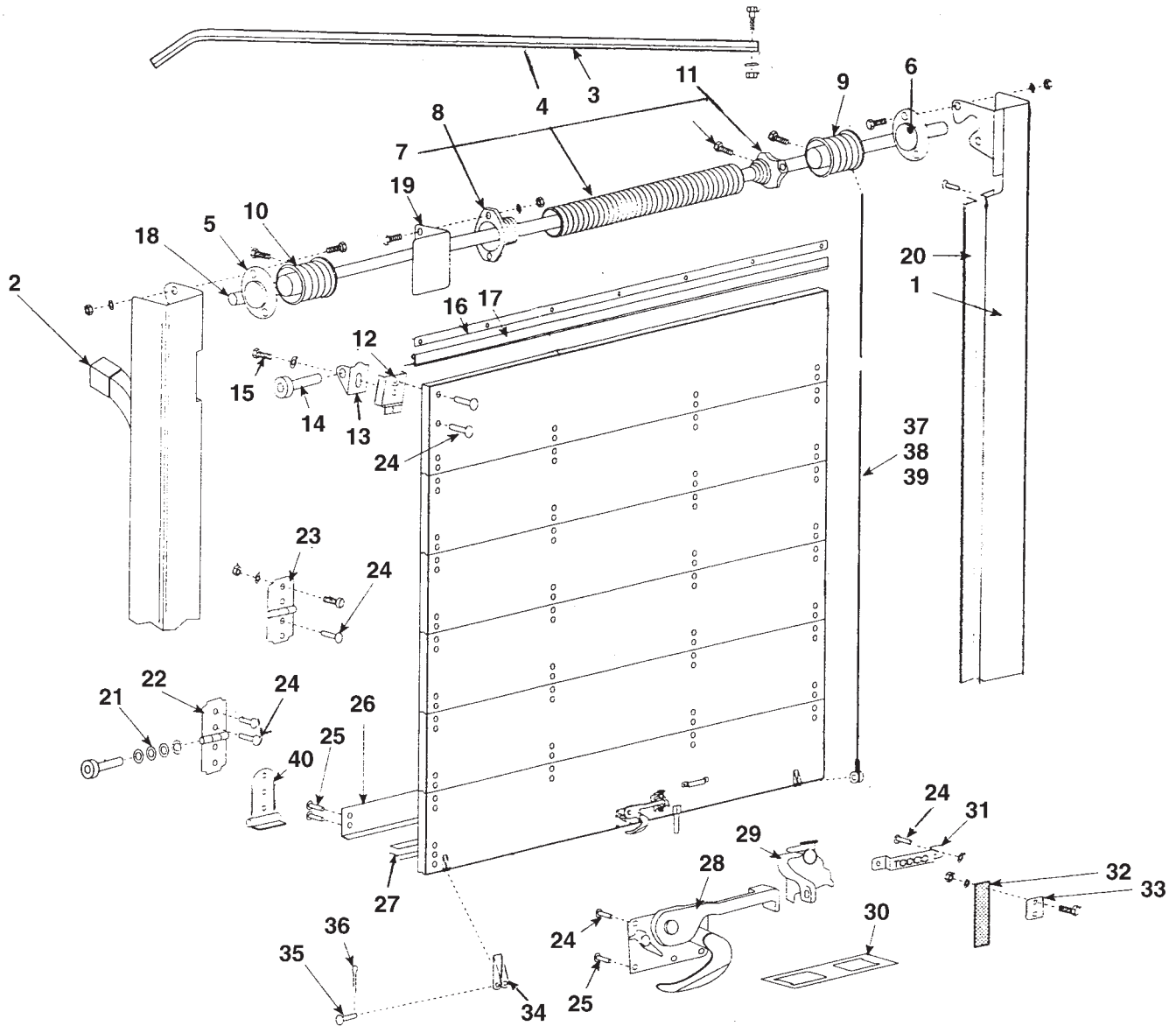

**TODCO 3/4" DRY FREIGHT DOOR**

## TODCO 3/4" DRY FREIGHT DOOR (OUTSIDE CABLES)

Item	Part No.	Description	Item	Part No.	Description
1	TO-49014-1	Vertical Track CS	20	TO-61390	Side Seal
2	TO-49014-2	Vertical Track RS	21	TO-80020	Roller Spacer Washer
3	TO-49406-1	Horizontal Track CS	22	TO-69035	End Hinge
	TO-49702-1			TO-70236	Heavy Duty End Hinge
	TO-49895-5		23	TO-61196	Center Hinge
TO-49406-2	TO-70238	Heavy Duty Center Hinge			
4	TO-49702-2	Horizontal Track RS	24	TO-89210-0032	1" Rivet
	TO-49895-6		25	TO-89210-0036	1-1/8" Rivet
	TO-51038		26	TO-61191	Bottom Angle
5	TO-51038	Bearing Assembly	27	TO-80840-1	Bottom Seal
6	TO-80701-2	Bearing	28	TO-69571	Lock Assembly
7	TO-51065	57" Spring w/Plugs	29	TO-69572	Keeper
8	TO-51043	Spring Anchor Plug	30	TO-69341	Catch Box
	TO-59129-1	Cable Drum CS	31	TO-61401	Lift Handle
TO-59157-3	Cable Drum RS		32	TO-80844-16	Pull Strap 16"
10		TO-59129-2	TO-59157-4	33	TO-69832-NS
	TO-59158	Winding Plug	34	TO-61204	Cable Bracket
12	TO-69432	Adjustable Base	35	TO-61026	Cable Pin
13	TO-69431	Adjustable Slide	36	TO-80401-316	Cotter Pin 3/32" X 1"
14	TO-70317-1	1" Sealed Roller	37	TO-51044	Cable 110" Stn. Stl.
15	TO-89049	3/8" Bolt	38	TO-59004	Cable 115" Stn. Stl.
16	TO-61403	Retainer	39	TO-59003	Cable 130" Stn. Stl.
17	TO-61402	Header Seal	40	TO-61352	Bottom Fixture
18	TO-51037	Counter Balance Shaft			
19	TO-51036-1	Spring Anchor Brkt CS			
	TO-51036-2	Spring Anchor Brkt RS			

# Todco Roll-Up Doors



## TODCO HORIZONTAL TRACK IDENTIFICATION

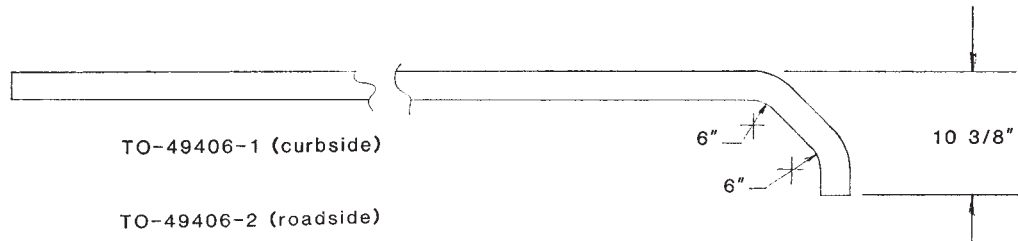

**TO-49406-1** Curbside  
**TO-49406-2** Roadside

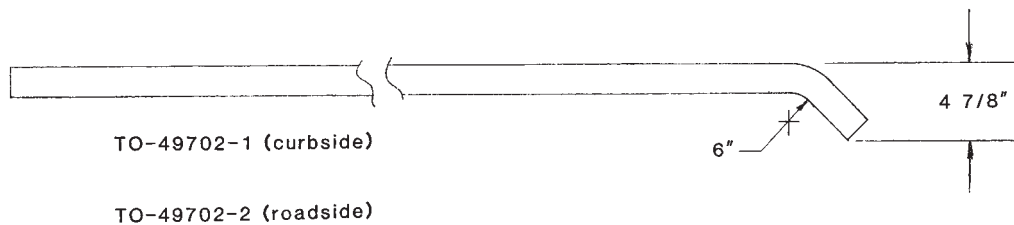

**TO-49702-1** Curbside  
**TO-49702-2** Roadside

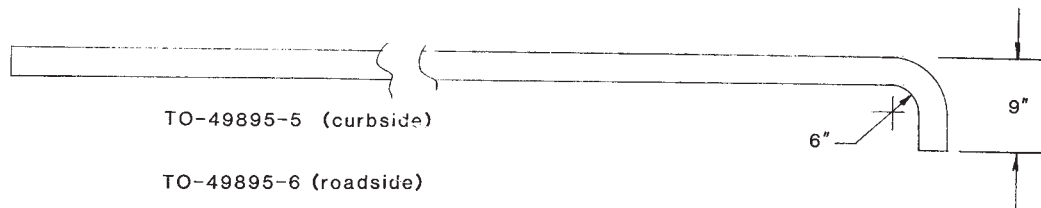

**TO-49895-5** Curbside  
**TO-49895-6** Roadside

Note: Use Vertical Track Part Nos. TO-49458-1 & -2 with this Horizontal Track

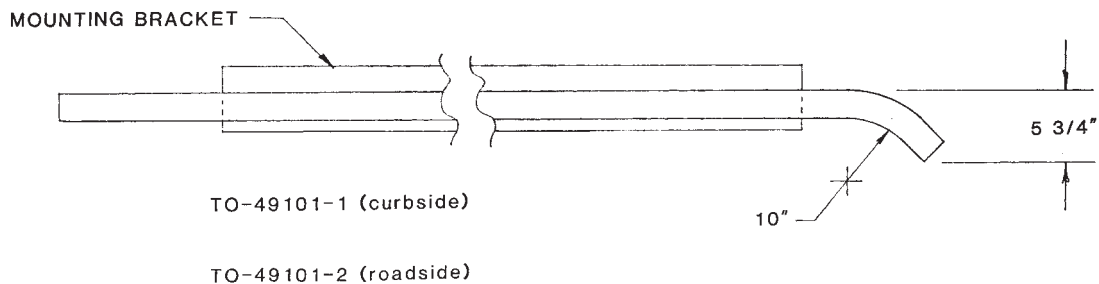

**TO-49101-1** Curbside  
**TO-49101-2** Roadside

Note: Lower Track for 2-1/2" Polar Guard



**Spring**  
TO-51042-40  
1-3/4" X 40"



**Counter Balance Assembly 96"**  
TO-59292 Comes with 59129-1 & -2 Cable Drums  
TO-59293 Comes with 59157-3 & -4 Cable Drums

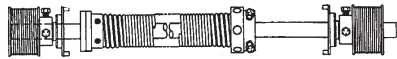

**Counter Balance Assembly**  
TO-59220  
For Shallow Header



**Bearing Bracket Assembly**  
TO-59206  
For Shallow Header

**Counter Balance Conversion Kit**  
TO-99030-3

- Kit Includes:
- 1 - TO-59292 Counter Balance
  - 2 - TO-59004 Cables
  - 2 - TO-61026 Cable Pins
  - 2 - TO-80401-316 Cotter Pins



**Top Seal**  
TO-69718  
Uses Retainer TO-69790

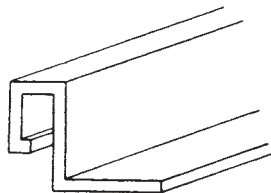

**Top Seal Retainer**  
TO-69790  
Uses Seal TO-69718



**Side Seal**  
TO-70338  
105"



**Side Seal (Long Lip)**  
TO-69840



**Side Seal Assembly**  
TO-69922

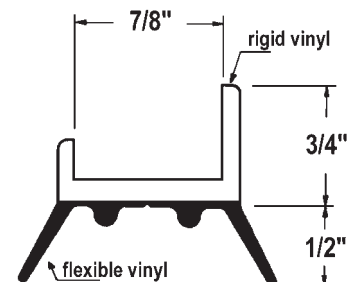

**Quick Change Bottom Seal**  
TO-70337

# Todco Roll-Up Doors

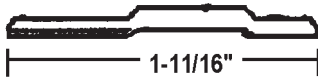

## Bottom Seal Retainer 97"

TO-69988

For 2-1/2" Polar Guard  
Uses Seal TO-69987

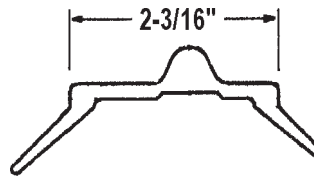

## Bottom Seal 97"

TO-69987

For 2-1/2" Polar Guard  
Uses Retainer TO-69988



## Safety Chain Assembly

TO-69020S

TO-61229 Safety Chain  
TO-61223 Safety Chain Lock

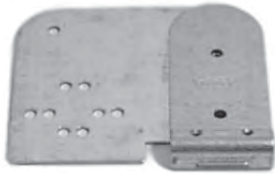

## Bottom Fixture

TO-69986-1 L.H.

TO-69986-2 R.H.

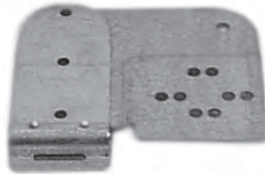

## Heavy Duty Bottom Fixture

TO-69964-1 L.H.

TO-69964-2 R.H.



## Removable End Hinge

TO-70311

## Top Fixtures



TO-61355



TO-69265



## End Hinge w/ Extension

TO-93494-A



## Top Fixture Complete

TO-69433



## Keeper Assembly

TO-69572

Uses TO-70058 Shim



## Padlock Keeper Back Plate

TO-69691



**Lock Assembly**  
TO-69571  
Uses TO-70057 Shim



**Lock Assembly**  
**3/8" Offset**  
TO-70223  
Uses TO-70057 Shim

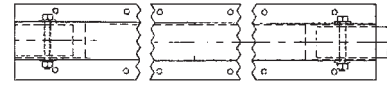

**Universal**  
**Door Guard**  
TO-39582  
Fits 89-1/2" to 97-1/4" Panel



**Life Guard Lock**  
TO-69807



**Todco 1" Steel**  
**Door Rollers**  
TO-70305 Sealed  
TO-70317-1 Sealed  
TO-70317-2



**Generic**  
**Replacement Todco**  
**1" Steel**  
**Door Roller**  
700-99-5

## TODCO DOOR CABLES

Part No.	Length	Application	Material	Eye Dia.
TO-51079-1	95"	Inside Cable	Stainless Steel	L.H.
TO-51079-2				R.H.
TO-51044	110"	Outside Cable		1/4"
TO-59004	115"			
TO-59003	130"			

## GENERIC REPLACEMENT FOR TODCO DOOR CABLES

Part No.	Length	Application	Material	Eye Dia.
700-515-17	110"	Outside Cable	Stainless Steel	1/4"
700-515-18			Galvanized Steel	
700-515-19	115"		Stainless Steel	
700-515-20			Galvanized Steel	
700-515-82	120"		Stainless Steel	
700-515-34	125"		Galvanized Steel	
700-515-21	130"		Stainless Steel	
700-515-22			Galvanized Steel	

# Todco Roll-Up Doors



## LISTING OF GENERIC PARTS THAT CAN REPLACE GENUINE TODCO

Todco Part No.	Trailmobile stocks genuine Todco as:	Trailmobile stocks generic replacement as:	Description of Trailmobile generic replacement:
T51037	TO-51037	GT-15	Counter Balance Shaft 96"
		GT-23	Counter Balance Shaft 100"
T51038	TO-51038	GT-5	Bearing Assembly
T59292	TO-59292	GT-6	Counter Balance
T61026	TO-61026	GT-7	Cable Anchor Pin
T61191	TO-61191	GT-21	Bottom Angle 98"
T61196	TO-61196	GT-3	Center Hinge
T61204	TO-61204	GT-16	Cable Anchor Bracket
T61223	TO-61223	GT-17	Safety Chain Lock
T61229	TO-61229	GT-18	Safety Chain
T61352	TO-61352	GT-8	Bottom Fixture
T61401	TO-61401	GT-9	Lift Handle
T61403	TO-61403	GT-22	Head Seal Retainer 96"
T69020S	TO-69020S	GT-19	Safety Chain Assembly
T69035	TO-69035	GT-4	End Hinge
T69432	TO-69432	GT-11	Adjustable Top Fixture Base
T69433	TO-69433	GT-12	Adjustable Top Fixture Assembly
T69571	TO-69571	GT-1	Security Lock
T69572	TO-69572	GT-2	Lock Keeper
T80840	TO-80840-1	GT-20	Bottom Seal 98"
T89210-0032	TO-89210-0032	GT-13	Rivet 1"
T89210-0036	TO-89210-0036	GT-14	Rivet 1-1/8"

## WHITING PREMIUM 3/4" DRY FREIGHT DOORS

Tongue & Groove

### Whiting Premium Door Assemblies with Track and Operator (Primer or White Paint)

With:

WH-11 8" Radius Horizontal Track

WH-2275 Vertical Track

WH-2376 Operator

#### with Bottom U-Channel

Door Size	90" X 90"	90" X 100"	98-1/4" X 100"	98-1/4" X 107"
Part No.	WH-90X90C	WH-90X100C	WH-96X100C	WH-96X107C
		WH-90X100C-PPW		

#### with Bottom Seal and Retainer

Door Size	98-1/4" X 107"
Part No.	WH-98X107C
	WH-98X107C-PPW

### Whiting Premium Door Assemblies without Track or Operator (Primer or White Paint)

#### with Bottom U-Channel

Door Size	90" X 90"	90" X 100"	98-1/4" X 100"	98-1/4" X 107"
Part No.	WH-90X90LTO	WH-90X100LTO	WH-96X100LTO	WH-96X107LTO
		WH-90X100LTO-PPW		

#### with Bottom Seal and Retainer

Door Size	98-1/4" X 107"
Part No.	WH-98X107LTO
	WH-98X107LTO-PPW



# Whiting Roll-Up Doors

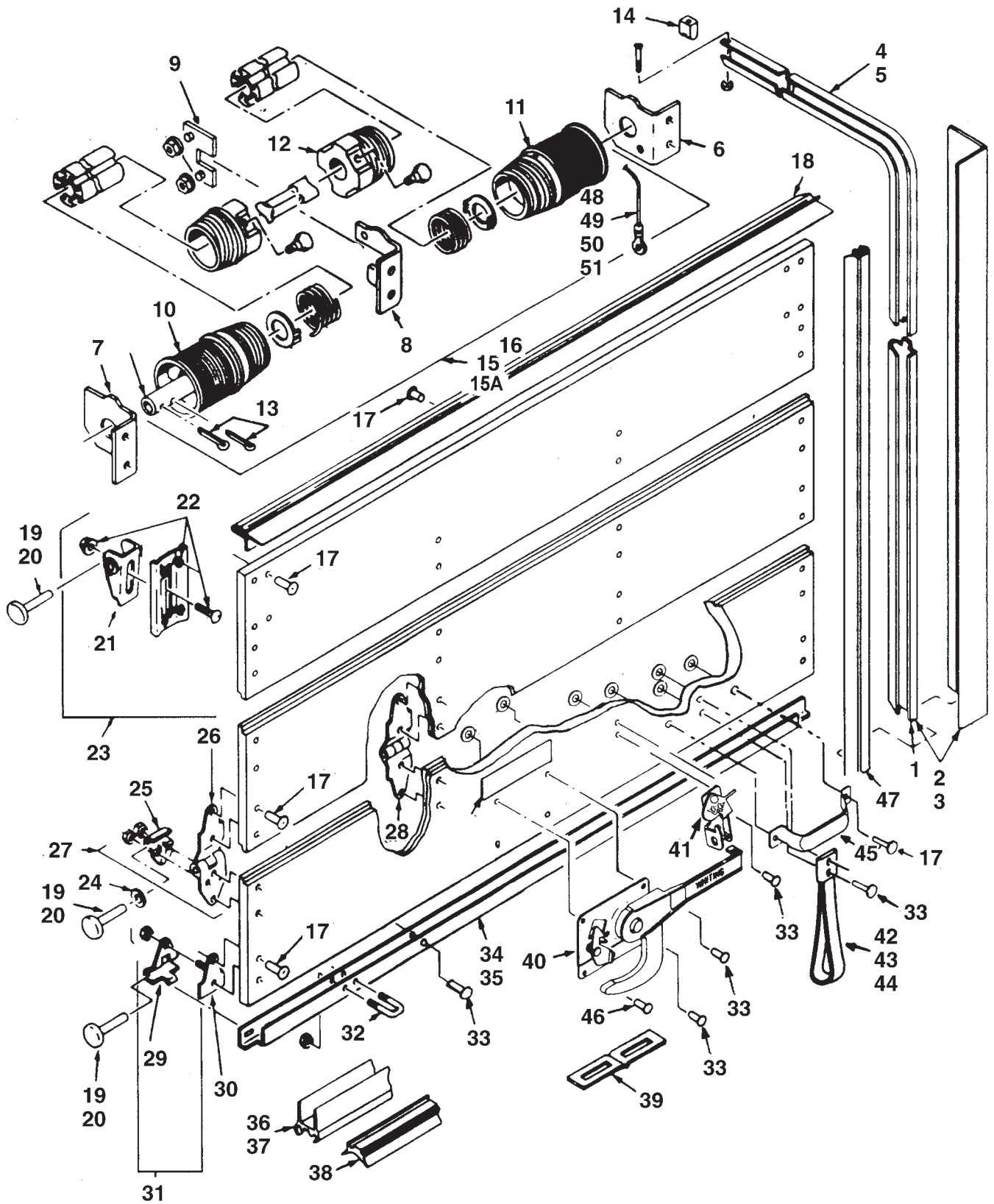

**WHITING PREMIUM 3/4" DRY FREIGHT DOOR**

8-50 Doors and Accessories

## WHITING PREMIUM 3/4" DRY FREIGHT DOOR

Item	Part No.	Description	Item	Part No.	Description
1	WH-1031	Vertical Track 112"	25	WH-1208	Roller Hinge Cover
2	WH-2275-1	Wide Track Mtg. Angle 107" CS	26	WH-1207	Roller Hinge
3	WH-2275-2	Wide Track Mtg. Angle 107" RS	27	WH-1209-A	Roller Hinge Complete
4	WH-11-2	Horizontal Track CS 8"	28	WH-15	Center Hinge
	WH-11-4	Horizontal Track CS 10"	29	WH-1021	Bottom Roller Cover
5	WH-11-3	Horizontal Track RS 8"	30	WH-1370	Bottom Brkt Stud Plate
	WH-11-5	Horizontal Track RS 10"	31	WH-1371	Bottom Brkt Complete
6	WH-2523	Balancer Bracket CS	32	WH-70-13	U Bolt 1-1/4"
7	WH-2524	Balancer Bracket RS	33	WH-10-1002-11	Rivet 1/4" X 1-1/8"
8	WH-2525	Balancer Bracket Center	34	WH-18-3-90	Bottom U Channel 90"
9	WH-2526	Balancer Bracket Clamp	35	WH-18-3-96	Bottom U Channel 96"
10	WH-2548	Cable Drum CS	36	WH-8280-90	Bottom Seal Retainer 90"
11	WH-2547	Cable Drum RS	37	WH-8280-96	Bottom Seal Retainer 96"
12	WH-2518	Winding Cone	38	WH-5735	Bottom Seal 96"
13	WH-10-1009-8	Cotter Pin 3/16" X 1-1/2"	39	WH-2804	Latch Plate
14	WH-83	Track Stop Bumper	40	WH-77	Lock Assembly
15	WH-2376-87	Balancer Assembly	41	WH-7515	Handle Keeper
15A	WH-2376-86.5	Balancer Assembly	42	WH-9723	Pull Strap 19"
16	WH-2376-93	Balancer Assembly	43	WH-9723-1	Pull Strap 32"
17	WH-10-1002-3	Rivet 1/4" X 1"	44	WH-9723-2	Pull Strap 42"
18	WH-4032	Top Seal 97"	45	WH-1715	Grab Handle
19	WH-2996	Steel Roller 2"	46	WH-10-1002-9	Rivet 1/4" X 1-5/16"
20	WH-3228	Nylon Roller 2"	47	WH-5423	Side Seal 120"
21	WH-6943	Top Closure Slide	48	WH-1-1	Cable 125" SS
22	WH-1264	Top Closure Base	49	WH-1-2	Cable 156" SS
23	WH-6944	Top Closure Assembly	50	WH-1-4	Cable 130" SS
24	WH-6	Spacer Washer	51	WH-1-7	Cable 97" SS

# Whiting Roll-Up Doors

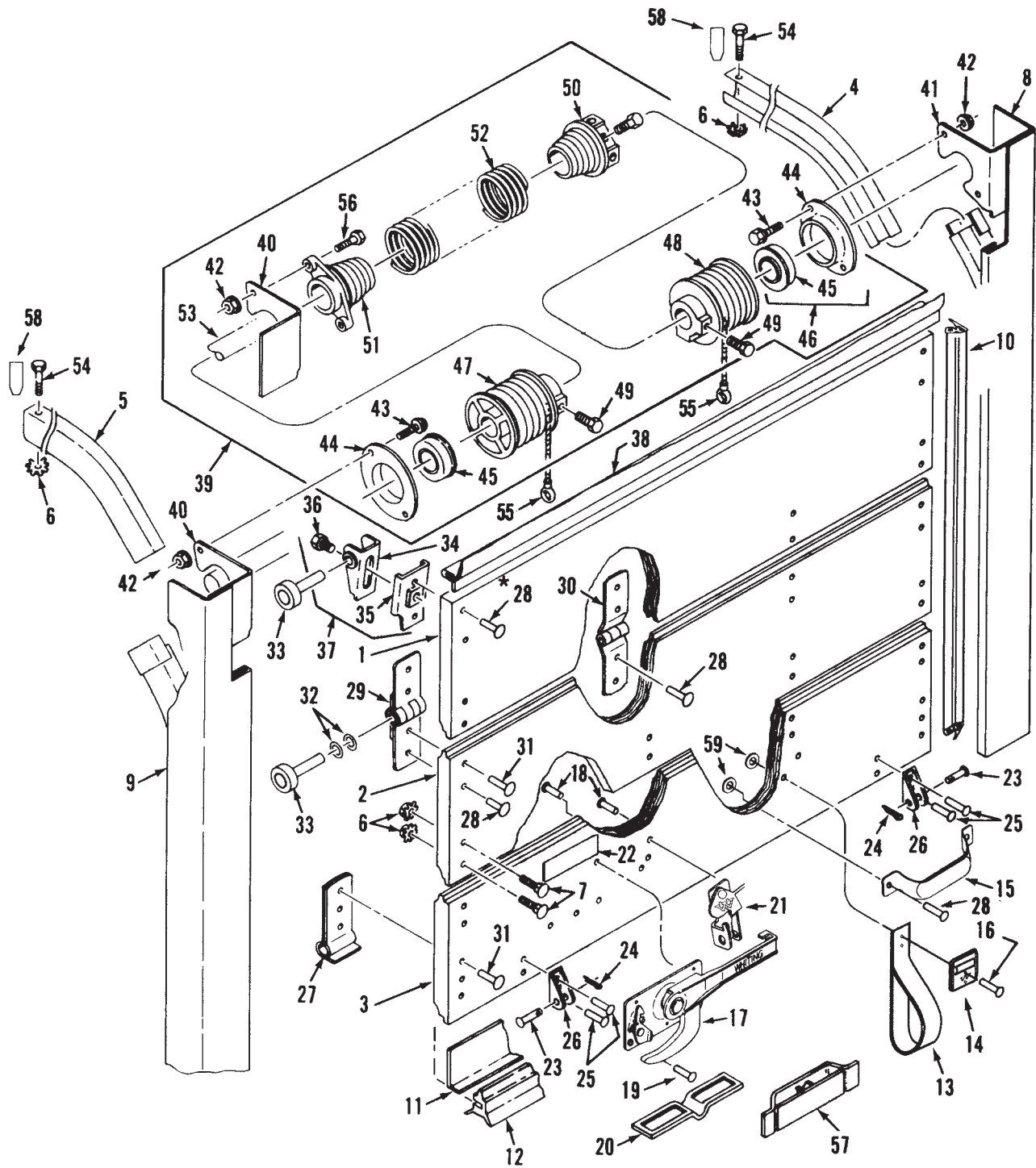

8-52 Doors and Accessories

**WHITING GENERAL PURPOSE 3/4" DRY FREIGHT DOOR**

## WHITING GENERAL PURPOSE 3/4" DRY FREIGHT DOOR

Item	Part No.	Description	Item	Part No.	Description
1	4441	Top Panel	31	10-1002-36	Rivet, 1/4 X 1-1/8 x 3/4" Head
2	4042	Intermediate Panel, No Hardware	32	6	Spacer Washer, Roller
3	4445	Bottom Panel, Complete	33	4027	Roller, 1" Stamped, Steel
4	4053	Horizontal Track, LH, CS	34	4038	Slide, Adjustable Top Fixture
5	4052	Horizontal Track, RH, RS	35	4051	Base, Adjustable Top Fixture
6	10-1022-1	Hex Nut, Self-locking, 1/4 NC	36	10-1073-2	Bolt, Adjustable Top Fixture
7	10-1003-8	Step Bolt	37	4039	Adjustable Top Fixture Assy, Complete
8	4046	Vertical Track & Mounting Angle, LH, CS	38	4032	Top Seal
9	4045	Vertical Track & Mounting Angle, RH, RS	39	4090	Balancer Assy, Complete less Mtg Brackets
10	4019	Side Seal, Each	40	4028	Balancer Mtg Bracket, RH, RS & Center
11	4034	Bottom Angle Seal Retainer, No Holes	41	4029	Balancer Mounting Bracket, LH, CS
12	3257	Bottom Seal	42	10-1063-1	Hex Nut, Self-locking, 5/16 NC
13	9723	Pull Strap, 19" with #7575 Retainer	43	10-1010-8	Bolt, 5/16 NC X 5/8"
14	7575	Pull Strap Retainer	44	4023	Bearing Retainer
15	1715	Lift Handle	45	10-1025-4	Bearing
16	10-1002-4	Rivet, 1/4 X 1-3/16 X 3/4" Head	46	4033	Bearing & Retainer Assy, 1" Ball Bearing
17	4077	Cam Lock, No Keeper	47	4014	Cable Drum, 3" Dia, RS, RH
18	10-1002-42	Rivet, 1/4 X 1-1/16 x 3/4" Head	48	4013	Cable Drum, 3" Dia, CS, LH
19	10-1002-11	Rivet, 1/4 X 1-1/8 x 1/2" Head	49	2699	Hex Head Set Screw, 3/8 NC X 7/8"
20	4021	Latch Plate	50	4050	Spring Winding Plug, 1-3/4"
21	7515	Keeper Assembly	51	4025	Spring Anchor Plug, 1-3/4"
22	3034	"Do Not Move" Decal	52	2701	Torsion Spring, 1-3/4" Dia
23	10-1004-2	Cable Anchor Clevis Pin	53	3100	Counterbalance Shaft
24	10-1009-5	Cotter Pin	54	10-1010-31	Hex Head Bolt, 1/4 NC X 2"
25	10-1002-9	Rivet, 1/4 X 1-5/16 x 1/2" Head	55	4020-1	Stn Steel Cable Assy, 1/4 Eye, 115"
26	4004	Cable Anchor Bracket	56	10-1010-9	Hex Head Bolt, 5/16 NC X 1"
27	4003	Bottom Roller Fixture	57	4024	Catch Box
28	10-1002-3	Rivet, 1/4 X 1 X 3/4" Head	58	4204	1" Track Stop Bumper
29	4007	End Hinge	59	10-1006-1	Washer
30	4012	Center Hinge			

# Whiting Roll-Up Doors



## WHITING GENERAL PURPOSE 3/4" DRY FREIGHT DOOR Tongue & Groove

### Whiting General Purpose Door Assemblies with Track and Operator (Primer)

With:

- 4052 Horizontal Track – RS
- 4053 Horizontal Track – CS
- 4045 Vertical Track – RS
- 4046 Vertical Track – CS
- 4090 Operator

Door Size	90" X 90"	90" X 100"	98-1/4" X 100"	98-1/4" X 107"
Part No.	WH-GP90X90C	WH-GP90X100C	WH-GP96X100C	WH-GP96X107C

### Whiting General Purpose Door Assemblies without Track or Operator (Primer)

Door Size	90" X 90"	90" X 100"	98-1/4" X 100"	98-1/4" X 107"
Part No.	WH-GP90X90LTO	WH-GP90X100LTO	WH-GP96X100LTO	WH-GP96X107LTO

## REPLACEMENT WHITING 3/4" DOOR PANELS

### Door Panel Configuration for Premium Doors

Height	90"	100"	107"
Top Panel	(1) 17"	(1) 16"	(1) 17"
Intermediate Panels	(4) 15"	(2) 15"	(5) 15"
		(3) 13"	
Bottom Panel	(1) 13"	(1) 15"	(1) 15"

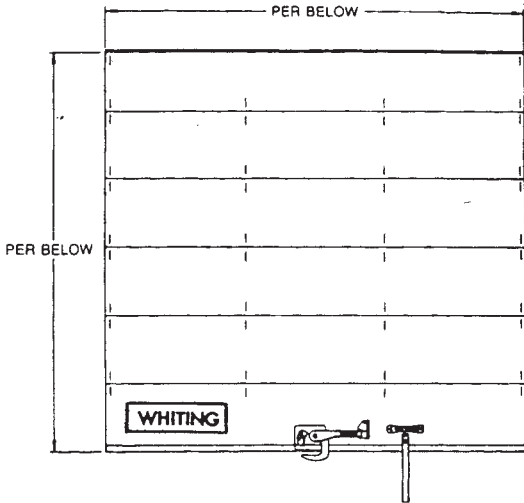

### Door Panel Configuration for General Purpose Doors

Height	90"	100"	107"
Top Panel	(1) 15"	(1) 16"	(1) 17"
Intermediate Panels	(4) 15"	(2) 15"	(5) 15"
		(3) 13"	
Bottom Panel	(1) 15"	(1) 15"	(1) 15"

### Top Panels

Part No.	Type	Panel Size	Finish
WH-240-15X96	Ship Lap	15" X 98-1/4"	Primer
WH-340-18x96	Tongue & Groove	18" X 98-1/4"	

### Intermediate Panels

Part No.	Type	Panel Size	Finish
WH-242-11X96	Ship Lap	11" X 98-1/4"	Primer
WH-242-12X96		12" X 98-1/4"	
WH-242-13X96		13" X 98-1/4"	
WH-242-14X96		14" X 98-1/4"	
WH-242-15X96		15" X 98-1/4"	
WH-342-11X96	Tongue & Groove	11" X 98-1/4"	
WH-342-11.5X96		11.5" X 98-1/4"	
WH-342-12X96		12" X 98-1/4"	
WH-342-13X96		13" X 98-1/4"	
WH-342-14X96		14" X 98-1/4"	
WH-342-15X96		15" X 98-1/4"	

# Whiting Roll-Up Doors



## Bottom Panels

Part No.	Configuration	Type	Finish	Panel Size
WH-243-12X96	Plain -- No Hardware	Ship Lap	Primer	12" X 98-1/4"
WH-243-15X96				15" X 98-1/4"
WH-343-11.5X96		Tongue & Groove		11-1/2" X 98-1/4"
WH-343-15X96				15" X 98-1/4"
WH-343-15.5X96				15-1/2" X 98-1/4"
WH-353-12X96			Aluminum Covered; PPW	12" X 98-1/4"
WH-353-15X96				15" X 98-1/4"
WH-245-15X90-LS CUT	With U Channel; No Cut Out	Ship Lap	Primer	15" X 90"
WH-245-15X96-LS CUT				15" X 98-1/4"
WH-245-15X90	With U Channel; With Cut Out for #70 Lock			15" X 90"
WH-245-15X96				15" X 98-1/4"
WH-246-11X96	With U Channel; With Lift Handle, Pull Strap, Bottom Roller Bracket			11" X 98-1/4"
WH-246-12X96				12" X 98-1/4"
WH-246-13X96				13" X 98-1/4"
WH-246-15X90				15" X 90"
WH-246-15X96				15" X 98-1/4"
WH-346-11.5X96				Tongue & Groove
WH-248-12X90	With 1676 Rubber Bottom Seal; Complete with #77 Lock	Ship Lap	Primer	12" X 90"
WH-248-12X96				12" X 98-1/4"
WH-248-15X90				15" X 90"
WH-248-15X96				15" X 98-1/4"
WH-345-3-11X96	With Seal and Retainer	Tongue & Groove	Primer	11" X 98-1/4"
WH-345-3-12X90				12" X 90"
WH-345-3-12X96				12" X 98-1/4"
WH-345-3-13X90				13" X 90"
WH-345-3-13X96				13" X 98-1/4"
WH-345-3-15X90				15" X 90"
WH-345-3-15X96				15" X 98-1/4"

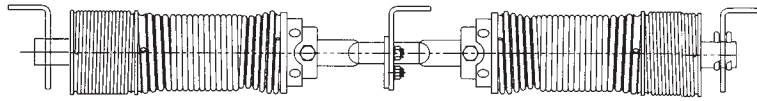

**Counter Balance Assembly**  
WH-7176-92



**Conversion Kit**  
WH-7905  
For 7176 Counter Balance

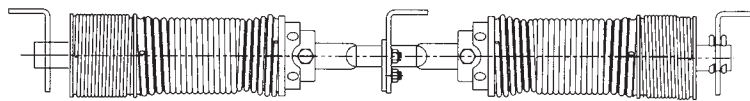

**Counter Balance Assembly**  
WH-2376-87 96" Trailer  
WH-2376-93 102" Trailer  
WH-2376-93-192X32.5  
For Doors 98" X 107" and Taller

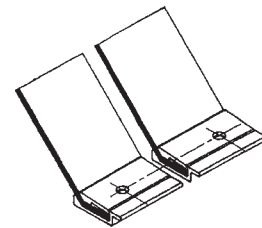

**Auxiliary Side and Header Seal**  
WH-3766

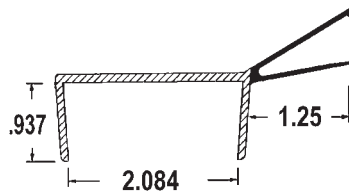

**Top Seal**  
WH-5464-96 97"  
For Insulated Door



**Top Closure Bracket**  
WH-1336-1 CS  
WH-1336-2 RS  
For Insulated Door



**Side Seal**  
WH-7470 100"  
For Insulated Door

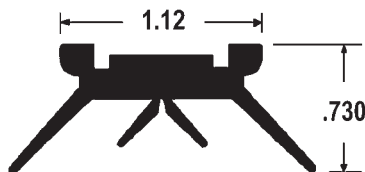

**Bottom Seal**  
WH-3765  
Use with old-style 1801 Retainer



**Pull Straps**  
WH-9723 19"  
WH-9723-1 32"  
WH-9723-2 42"



**U-Bolts**  
WH-70-13 1-1/4"  
WH-70-5 1-1/2"  
WH-70-19 1-3/4"  
WH-70-10 2-1/4"



# Whiting Roll-Up Doors



**Keeper Assembly**  
WH-7515



**Recessed Cam Lock**  
WH-70



**Flush Mount Lock**  
WH-70-300



**Outside Cam Lock**  
WH-77  
WH-77-1 Offset



**Cam Lock**  
WH-75  
For 3/4" Dry Freight Door



**Cam Lock**  
WH-75-10  
For Insulated Door

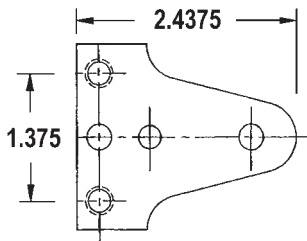

**Bottom Roller Adapter Plate**  
WH-2694



**Bottom Roller Wear Plate**  
WH-5726



**Bottom Roller Bracket**  
WH-85



**Chain Lock**  
WH-59  
Less Chain

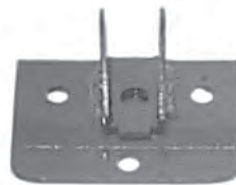

**Cable Anchor**  
WH-5803



**Catch Box**  
WH-4024

## WHITING DOOR CABLES

Part No.	Length	Eye Dia.	Eye Color	Material
WH-1-9	92"	5/16"	Plain	Stainless Steel
WH-1-7	97"			
WH-112-1	105"	7/16"	Yellow	
WH-1-11	115"	5/16"	Black	
WH-1-1	125"		White	
WH-112-3		7/16"	Red	
WH-1-4	130"	5/16"	Beige	
WH-1-2	156"		Orange	

## GENERIC REPLACEMENT FOR WHITING DOOR CABLES

Part No.	Length	Eye Dia.	Material
700-515-156	97"	5/16"	Galvanized Steel
700-515-23	105"	7/16"	Stainless Steel
700-515-24			Galvanized Steel
700-515-157	115"	5/16"	Stainless Steel
700-515-158			Galvanized Steel
700-515-25		7/16"	Stainless Steel
700-515-26			Galvanized Steel
700-515-27	125"	7/16"	Stainless Steel
700-515-28			Galvanized Steel
700-515-159	130"	5/16"	Stainless Steel
700-515-160			Galvanized Steel
700-515-29	135"	7/16"	Stainless Steel
700-515-30			Galvanized Steel

## DOOR ROLLERS



**2" Steel**  
**WH-2996**  
Generic 700-99-40



**2" Nylon**  
**WH-3228**  
Generic 700-99-4

# Whiting Roll-Up Doors



## LISTING OF GENERIC PARTS THAT CAN REPLACE GENUINE WHITING

Whiting Part No.	Trailmobile stocks genuine Whiting as:	Trailmobile stocks generic replacement as:	Description of Trailmobile generic replacement:
W10-1002-29		GW-7	Rivet 1-1/4"
W10-1002-3	WH-1002-3	GW-5	Rivet 1"
W10-1002-36	WH-1002-36	GW-6	Rivet 1-1/8"
W1209-A	WH-1209-A	GW-1	Roller Hinge Assembly
W1264	WH-1264	GW-9	Top Closure Base
W15	WH-15	GW-4	Center Hinge
W1715	WH-1715	GW-8	Lift Handle
W23		GW-12	Pull Strap Assembly 19"
		GW-14	Pull Strap Assembly 24"
		KI-1524	
W23-1		GW-13	Pull Strap Assembly 32"
W6943	WH-6943	GW-10	Top Closure Slide
W6944	WH-6944	GW-11	Top Closure Assembly
W7515	WH-7515	GW-3	Lock Keeper
W77	WH-77	GW-2	Security Lock

## Roll-Up Door Fasteners



**Tubular Rivets 1/4"**  
(Steel)

Part No.	Note
TO-89210-0032	1"
TO-89210-0036	1-1/8"
TO-89210-0040	1-1/4"
TO-89210-0044	1-3/8"
WH-10-1002-3	1" (3/4" Dia Head)
WH-10-1002-36	1-1/8" (3/4" Dia Head)
WH-10-1002-11	1-1/8" (1/2" Dia Head)
WH-10-1002-4	1-3/16" (3/4" Dia Head)
WH-10-1002-9	1-5/16" (1/2" Dia Head)



**Rhino Fastener Assembly**  
700-50-41



**Step Bolts**  
TO-80015-0040  
1/4" X 1-1/4"  
TO-80015-0052  
1/4" X 1-5/8"  
TO-80015-0096  
1/4" X 3"



**Elevator Bolts with KNut**

700-50-6 1/4" X 1-1/4"  
700-50-7 1/4" X 1-1/2"  
Replacement KNut  
WH-10-1022-1

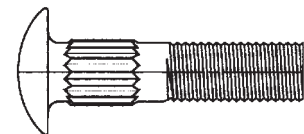

**Rib Neck Step Bolts**  
WH-10-1003-8  
1/4" X 1-1/4"  
WH-10-1003-2  
1/4" X 1-3/4"

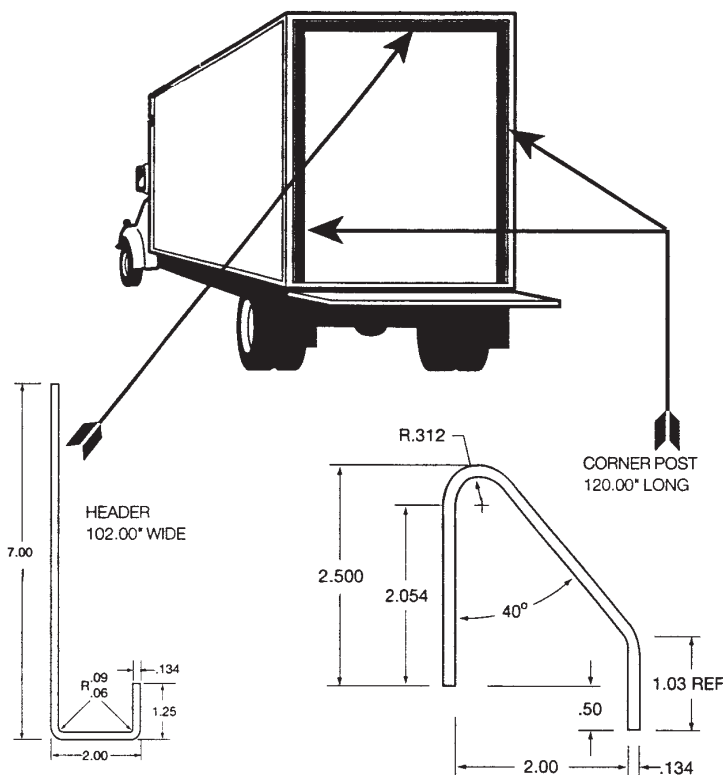

## Conversion Kit 700-512-11

For converting swing doors to roll-up doors.

Remove old swing doors; weld conversion corner posts and header; trailer is now ready for roll-up door installation.

Corner posts have added lip length to allow easier welding during installation.

10 gauge (.134) steel construction; plain finish.

Each kit includes two corner posts and one header.



## Roll-Up Door Track Protector 700-512-15 Length 24"

<b>MALE CONNECTORS .....</b>	<b>9-1</b>
<b>FEMALE RECEPTACLES WITH CIRCUIT BREAKERS .....</b>	<b>9-2</b>
<b>FEMALE RECEPTACLES WITHOUT CIRCUIT BREAKERS .....</b>	<b>9-3 TO 9-4</b>
<b>RECEPTACLE ACCESSORIES .....</b>	<b>9-5</b>
<b>JUNCTION BOXES .....</b>	<b>9-6</b>
<b>CABLE AND WIRE .....</b>	<b>9-7 TO 9-8</b>
<b>SEALED BEAM LAMPS .....</b>	<b>9-9 TO 9-10</b>
<b>MINIATURE LAMPS .....</b>	<b>9-11 TO 9-12</b>
<b>FLASHERS .....</b>	<b>9-12</b>
<b>WIRING HARNESSSES .....</b>	<b>9-13</b>
<b>MISCELLANEOUS INCLUDING DRY-CELL BATTERIES .....</b>	<b>9-14 TO 9-15</b>



**Single Pole Connector**  
700-17-73  
Phillips 15-335



**4-Way Connector**  
MI-BE23403  
Haldex BE23403



**6-Way Connector**  
MI-BE23603  
Haldex BE23603



**6-Way Connector with Cable Guard**  
700-17-157  
Phillips 15-630



**ISO Connector with Cable Guard**  
PH-15-830  
Phillips 15-830



**7-Way Connector**  
700-17-19  
Phillips 15-710

## 7-Way Connector with Cable Guard



700-17-22  
Phillips 15-730



MI-BE23784  
Haldex BE23784

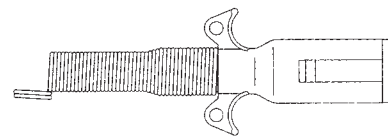

700-29-488  
Globetech GT-3007B



**7-Way Connector PermaPlug**  
PH-16-730  
Phillips 16-730

# Female Receptacles with Circuit Breakers



**7-Way Receptacle**  
with 15 Amp Circuit Breakers  
and Solid Pins  
TL-50806  
TL-50808 Cover Kit



**7-Way Receptacle**  
with 15 Amp Circuit Breakers  
and Split Pins  
29-2-89  
Haldex BE24015



**7-Way Receptacle  
Assembly**  
with 15 Amp Circuit Breakers  
and Split Pins  
700-17-26  
Haldex BE24115



**7-Way Receptacle**  
with 20 Amp Circuit Breakers  
and Solid Pins  
TL-50864  
TL-50875 Cover Kit



**7-Way Receptacle**  
with 20 Amp Circuit Breakers  
and Split Pins  
MI-BE24020  
Haldex BE24020



**7-Way Receptacle  
Assembly**  
with 20 Amp Circuit Breakers  
and Split Pins  
29-2-89  
Haldex BE24015

**7-Way Receptacle**  
with 20 Amp Circuit Breakers and Split Pins



TL-50865  
TL-50875 Cover Kit



29-2-67  
Phillips 15-762



**7-Way Receptacle  
Assembly**  
with 20 Amp Circuit Breakers  
and Split Pins  
700-29-479  
Phillips 15-7629

**7-Way Receptacle**  
with 30 Amp Circuit Breakers and Split Pins



MI-BE24030  
Haldex BE24030



700-17-101  
Phillips 15-763



**Single Pole Receptacle**  
700-17-72  
Phillips 15-320



**ISO Receptacle**  
PH-16-826  
Phillips 16-826



**ISO Receptacle with Ring Terminals**  
PH-16-822  
Phillips 16-822



**4-Way Receptacle with Split Pins**  
MI-BE23402  
Hallex BE23402



**6-Way Receptacle with Split Pins**  
MI-BE23602  
Hallex BE23602



**7-Way Receptacle with Bullet Terminals**  
**Sta-Dry**  
PH-16-724  
Phillips 16-724

**7-Way Receptacle with Solid Pins**

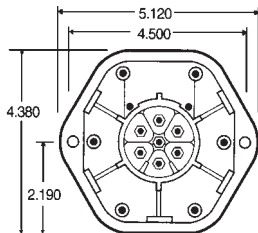

TL-50860



TL-50805  
TL-50808 Cover Kit



**7-Way Receptacle (Right Angle) with Solid Pins**  
TL-50822  
TL-50808 Cover Kit

**7-Way Receptacle with Split Pins**



MI-BE24000  
Hallex BE24000



MI-BE24001  
Hallex BE24001



# Female Receptacles without Circuit Breakers



## 7-Way Receptacle with Split Pins



**MI-BE23703**  
Haldex BE23703



**700-29-489**  
Globetech GT-3227



**29-2-121**  
Phillips 15-760



**PH-15-720**  
Phillips15-720



**29-A2-47**  
Tramec 38373  
700-29-464 Cover Kit



**7-Way Receptacle  
Assembly  
with Split Pins**  
**29-A2-46**  
Tramec 38383B  
700-29-464 Cover Kit



**7-Way Receptacle  
3-Hole Mount  
with Terminal Kit**  
**GR-87240**



**Adapter Housing**  
700-17-35  
Phillips 15-769



**Receptacle Mounting Box**  
GR-43684



**Receptacle Mounting Box (Dual)**  
PH-16-777  
Phillips 16-777



**Nose Box Housing (Bottom Access)**  
TL-50882



**Nose Box Housing (Rear Access)**  
TL-50883



**Replacement Cover Kit**  
MI-BQ24002  
Haldex BQ24002

## Receptacle Mounting Plate



29-4-475  
Aluminum



1029-4-158  
Aluminum



**Recessed Mounting Pan**  
9511-16-262  
Penz P80-197; Aluminum



**7-Pin Plug and Socket Brush**  
700-29-478  
Phillips 4-121



**Circuit Breaker**  
700-17-124 20 Amp  
700-17-126 30 Amp

# Junction Boxes

## 7-Terminal Box



**Distribution Module  
4-Outlet**  
TL-87804



**29-26-50**  
Uni-Bond JB0700



**700-17-58**  
Haldex BE22150



**Junction Box - Surface Mount**  
TL-50400



**Junction Box - Buckplate Mount**  
TL-50401



**Junction Box  
Hardware Kit**  
TL-50850



### Compression Fittings

Part No.	I.D.
TL-50840	3/8"
TL-50841	1/2"
TL-50842	3/4"
TL-50846	Flat Cable



**Jam Nut**  
TL-50845

Note: Black = Standard  
Green = ABS  
Yellow = ISO



## 7-Way Coiled Cables with Metal Plugs with Springs

Part No.	Color	Working Length	Conductors	Cross Reference
700-29-466	Black	12 Ft	6-12 Ga., 1-10 Ga.	Phillips 22-4321
700-29-474			6-14 Ga., 1-12 Ga.	Philatron 2812CM
700-29-465				Tramec 47A12
700-29-467		15 Ft	6-12 Ga., 1-10 Ga.	Phillips 22-4621
700-29-476			6-14 Ga., 1-12 Ga.	Philatron 2815CM
700-29-496				Tramec 47A15
700-29-498	Green			Tramec 4DA17
PH-31-9623	Yellow		1-8 Ga., 2-10 Ga., 4-12 Ga.	Phillips 31-9623



## 7-Way Coiled Cables with Plastic Plugs

Part No.	Color	Working Length	Conductors	Cross Reference
PH-30-9620	Green	15 Ft	1-8 Ga., 2-10 Ga., 4-12 Ga.	Phillips 30-9620
700-29-483				Philatron (ABS) 2-415-CL



## Single-Pole Coiled Lift Gate Cables with Metal Plugs with Springs

Part No.	Color	Working Length	Conductors	Cross Reference
700-29-470	Green	12 Ft	1-4 Ga.	Phillips 23-4325
700-29-471		15 Ft		Phillips 23-4625

# Cable and Wire



## Bulk Trailer Cable

Part No.	Number of Conductors	Conductors	Length	Red	Yellow	Green	Blue	White	Black	Brown
50-26B-27	4	4-14 Ga.	100 Ft	X	X			X	X	
700-17-74	6	6-14 Ga.	100 Ft	X	X	X		X	X	X
700-17-74-500			500 Ft							
700-29-485-100	7	6-12 Ga., 1-10 Ga.	100 Ft	X	X	X	X	X	X	X
700-29-485-500			500 Ft							
700-29-486-100		6-14 Ga., 1-12 Ga.	100 Ft							
700-29-486-500			500 Ft							

## Bulk Duraflex Cable

Part No.	Number of Conductors	Conductors	Length	Red	Yellow	Green	Blue	White	Black	Brown
700-29-487-100	7	6-14 Ga., 1-12 Ga.	100	X	X	X	X	X	X	X



## Primary Wire

100-Ft Spools

12 GAUGE		14 GAUGE
Part No.	Color	Part No.
700-29-416	Red	700-29-111
700-29-417	Green	700-29-112
700-29-418	Blue	700-29-113
700-29-419	Black	700-29-114
700-29-420	Yellow	700-29-115
700-29-421	Brown	700-29-116
700-29-422	White	700-29-117

## ABS Cable

700-29-497-100

Green; 100 Ft

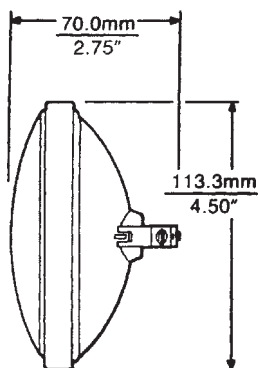

## Round PAR-36 Bulb

Part No.	Base Type	Primary Application
LB-4411	2 Screw Terminals	Tractor
LB-4415		Fog
LB-4416		Spotlamp, Signal
LB-4509		For Truck-Lite 80374

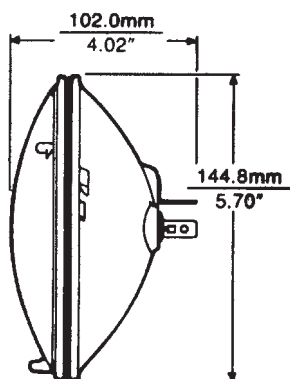

## Round PAR-46 Bulb

Part No.	Base Type	Primary Application
LB-4000	3 Contact Lugs	Auto Hi-Low Beam

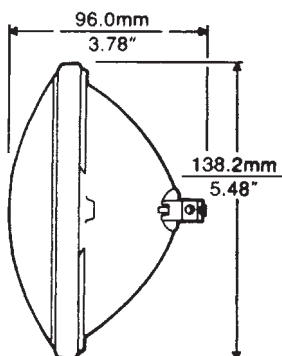

## Round PAR-46 Bulb

Part No.	Base Type	Primary Application
LB-4412	2 Screw Terminals	Fog
LB-4412A		Fog - Yellow

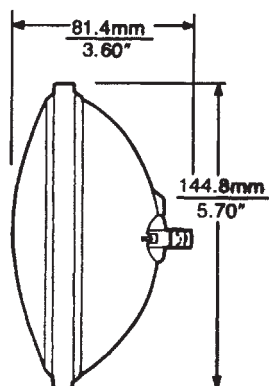

## Round PAR-46 Bulb

Part No.	Base Type	Primary Application
LB-4421	2 Slip-On Terminals	Auto/Truck Special Service
LB-4537		Aircraft Landing

# Sealed Beam Lamps

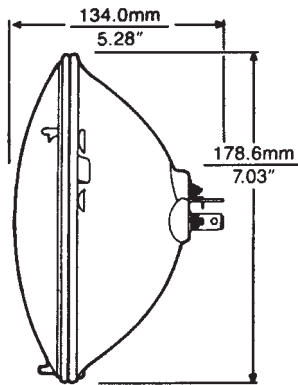

## Round PAR-56 Bulb

Part No.	Base Type	Primary Application
LB-6014	3 Contact Lugs	Auto Hi-Low Beam
LB-6015		Auto/Truck Hi-Low Beam
LB-H6024		Auto Hi-Low Beam

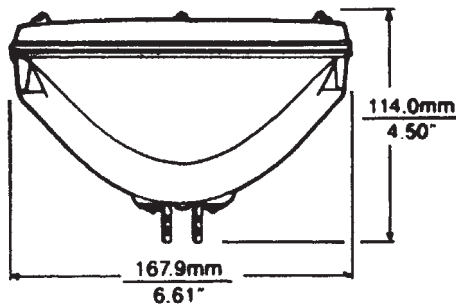

## Rectangular 100 x 165 Bulb

Part No.	Base Type	Primary Application
LB-H4651	2 Contact Lugs	Auto Hi Beam

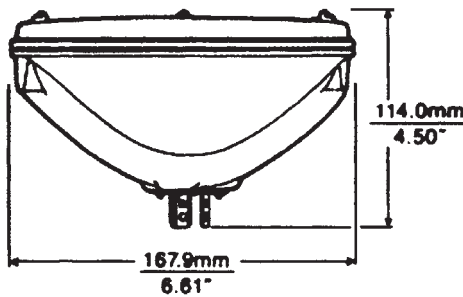

## Rectangular 100 X 165 Bulb

Part No.	Base Type	Primary Application
LB-4652	3 Contact Lugs	Auto Low Beam
LB-H4656		

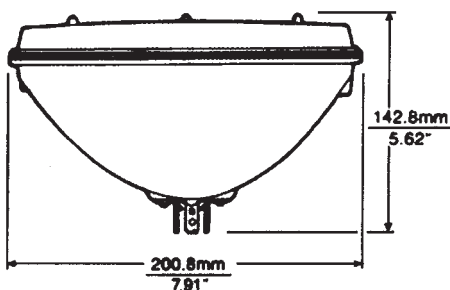

## Rectangular 142 X 200 Bulb

Part No.	Base Type	Primary Application
LB-6052	3 Contact Lugs	Auto Hi-Low Beam
LB-H6054		

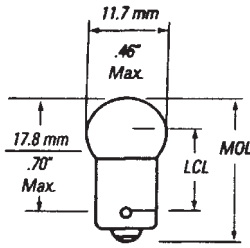

**LB-53T**

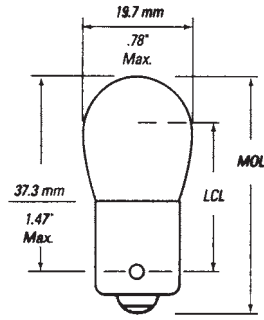

**LB-198T**

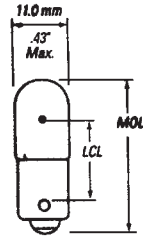

**LB-1889T**  
**LB-1893T**  
**LB-1891T**

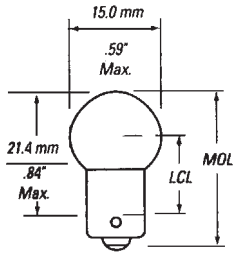

**LB-57T**  
**LB-293T**  
**LB-1895T**

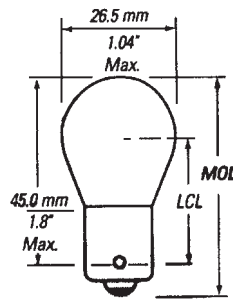

**LB-199T**

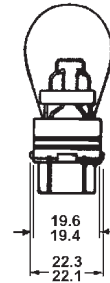

**LB-3156T**

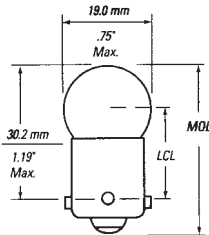

**LB-67T**  
**LB-89T**  
**LB-97T**  
**LB-1155T**

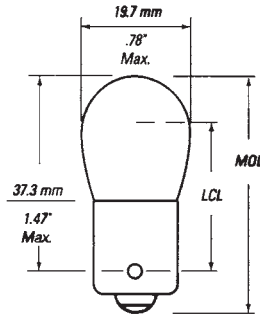

**LB-1003T**

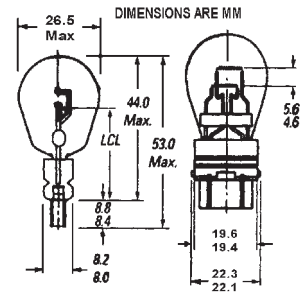

**LB-3157T**  
**LB-3157NAT** Amber

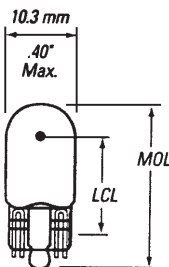

**LB-161T**

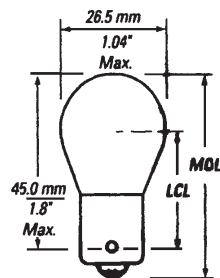

**LB-1141T**  
**LB-1156T**

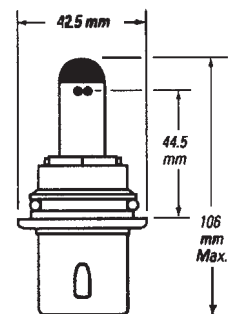

**LB-9004**



# Miniature Lamps

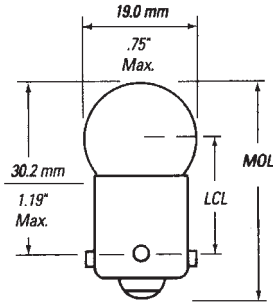

**LB-194T**

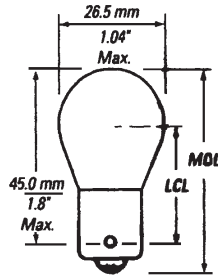

**LB-1157T**  
**LB-1157NAT** Amber

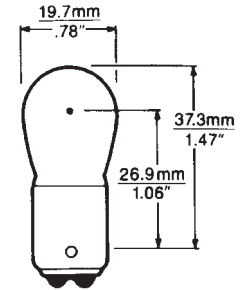

**LB-1004T**

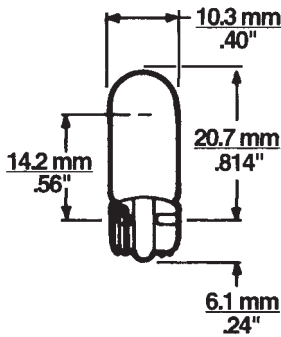

**LB-168T**

## Flashers



**Truck-Lite  
Ultra Flash**  
TL-97232

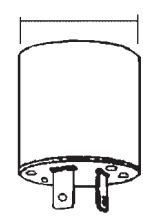

1 3/8"  
Dia.

**Grote  
10-Lamp Flasher**  
GR-44810  
12 Volt, 2-Pin

## 12-Lamp Flashers

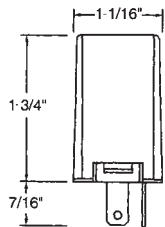

**Truck-Lite**  
TL-172  
12 Volt, 2-Pin



**Grote**  
GR-44530  
12 Volt, 2-Pin



**Grote**  
GR-44540  
12 Volt, 3-Pin

## Trailmobile Main Harness

<p><b>29-3-451A-530-1A</b> 53' Trailer; 7-Wire</p>	<p><b>TL-88794-0720</b> 53' Trailer; 6-Wire</p>	<p><b>TL-50957</b> Converter Dolly</p>
<p><b>Trailmobile Marker Light Adapter</b> 29-3-405</p>	<p><b>Trailmobile ABS Power Harness</b> TL-52104-1576</p>	<p><b>Trailmobile ABS Power Cable</b> 29-3-484</p>
<p><b>Trailmobile Rear Sill Harness</b></p>		<p><b>Trailmobile Upper Rear Triple Harness</b> 29-3-452-48 48 Inches</p>
<p><b>Adapter for 3-Light System</b> 29-3-368 Used with Trailmobile 6-Wire Harness</p>	<p><b>Trailmobile License Light Harness</b> 29-3-393-12</p>	

# Miscellaneous



**Toggle Switch**  
29-30-16  
Cup-Mounted;  
Cole Hersee 5543



**Turn Signal Switch**  
GR-48282



**Push-Pull Switch**  
SS-102

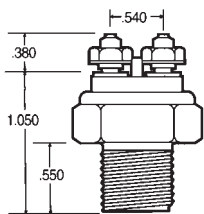

**Stop Light Switch**  
TL-50899



**ABS Accessory Switch**  
700-17-490  
Tramec 38041



**Receptacle Boot**  
TL-50890  
Rubber



**Circuit Tester**  
TL-97101

## Frame Clamps



Part No.	Tube Size	Mounting Hole Size
700-99-409	1/4"	1/4"
700-99-410	3/8"	
700-99-411	1/2"	
700-99-412	3/4"	
700-99-413	1"	

## Nylon Cable Ties

Part No.	Length
700-99-266	4"
700-99-267	6"
700-99-268	8-1/2"
700-99-269	11-3/4"
700-99-270	14-1/2"
700-99-271	15-1/2"

## Rubber Grommets

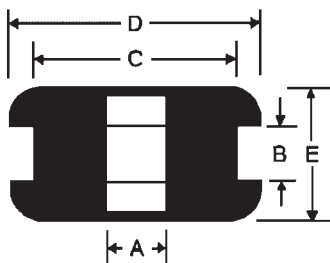

Part No.	A	B	C	D	E	TYPE
700-50-55	0.6875	0.1875	1	1.3125	0.50	Open
50-14-27	0.875	0.1875	1.25	1.625	0.5625	
50-14-125	0.9375	0.25	1.25	1.50	0.50	Closed
50-14-39	1.0625	0.125	1.25	1.75	0.4375	Open

**DURACELL BATTERIES**



**AA**

**700-99-502-AA-4PK**

4-Pack

**AAA**

**700-99-502-AAA-4PK**

4-Pack

**C**

**700-99-502-C-2PK**

2-Pack

**D**

**700-99-502-D-2PK**

2-Pack

**9-Volt**

**700-99-502-9V-1PK**

1-Pack

<b>GROTE – MOUNTING BRACKETS &amp; MARKER LAMPS .....</b>	<b>10-1 TO 10-2</b>
<b>GROTE – STOP, TURN, TAIL LAMPS .....</b>	<b>10-3</b>
<b>GROTE – HARNESES &amp; PIGTAILS .....</b>	<b>10-4 TO 10-5</b>
<b>GROTE – UTILITY &amp; LICENSE LAMPS; RUBBER GROMMET .....</b>	<b>10-5</b>
<b>GROTE – REPLACEMENT LENSES .....</b>	<b>10-6</b>
<b>PETERSON – REFLECTORS &amp; MARKER LAMPS .....</b>	<b>10-7 TO 10-9</b>
<b>PETERSON – STOP, TURN, TAIL LAMPS .....</b>	<b>10-9</b>
<b>PETERSON – LICENSE, UTILITY, &amp; DOME LAMPS .....</b>	<b>10-9</b>
<b>PETERSON – REPLACEMENT LENSES .....</b>	<b>10-10</b>
<b>PETERSON – PIGTAIL, CONNECTOR, &amp; MISCELLANEOUS .....</b>	<b>10-11</b>
<b>SAFE-T-SIGNAL – MID-SPAN TURN SIGNALS .....</b>	<b>10-11</b>
<b>TRUCK-LITE – REFLECTORS &amp; MOUNTING ACCESSORIES ...</b>	<b>10-12 TO 10-18</b>
<b>TRUCK-LITE – SOCKETS &amp; PLUGS; HARNESS SYSTEMS .....</b>	<b>10-18 TO 10-21</b>
<b>TRUCK-LITE – MARKER LAMPS .....</b>	<b>10-22 TO 10-26</b>
<b>TRUCK-LITE – STOP, TURN, TAIL LAMPS; MODULES .....</b>	<b>10-27 TO 10-30</b>
<b>TRUCK-LITE – TURN SIGNAL, BACK-UP, &amp; LICENSE LAMPS</b>	<b>10-31 TO 10-34</b>
<b>TRUCK-LITE – UTILITY, DOME, MULTI-PURPOSE, &amp; CAB ...</b>	<b>10-35 TO 10-36</b>
<b>TRUCK-LITE – REPLACEMENT LENSES &amp; MISC. ....</b>	<b>10-37 TO 10-38</b>
<b>UNI-BOND – MARKER LAMPS .....</b>	<b>10-39</b>
<b>UNI-BOND – STOP, TURN, TAIL LAMPS; MISC.....</b>	<b>10-40 TO 10-41</b>
<b>CROSS REFERENCE FROM TRUCK-LITE</b>	
<b>TO UNI-BOND GENERIC REPLACEMENT.....</b>	<b>10-41</b>



**Mounting Bracket  
U.S. 19 Series**  
GR-43390



**Surface Mount  
Bracket**  
**U.S. 10 and  
30 Series**  
GR-43690

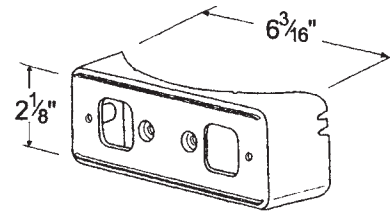

**Mounting Bracket  
6" Radius**  
GR-43050

## Grote - Marker Lamps



**Thin-Line Lamp**  
GR-45252 Red  
GR-45253 Amber



**Low-Profile Lamp**  
GR-45662 Red  
GR-45663 Amber



**No-Splice Lamp**  
GR-45432 Red  
GR-45433 Amber

### PIGTAIL-TYPE LAMPS



GR-46792 Red  
GR-46793 Amber



GR-45262 Red  
GR-45263 Amber



**Sentry Lamp  
Sealed**  
GR-53062 Red  
GR-53063 Amber

### Super Nova Thin-Line LED

(white body)  
GR-46902 Red  
GR-46903 Amber  
(red body)  
GR-46922 Red

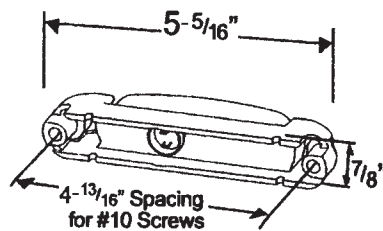

**Die-Cast Lamp**  
GR-46782 Red  
GR-46783 Amber

# Grote - Marker Lamps

## TURTLE-BACK LAMPS



**No-Splice**  
GR-45442 Red  
GR-45443 Amber



**Optic Lens**  
GR-45462 Red  
GR-45463 Amber



**Reflector Lens**  
GR-46302 Red  
GR-46303 Amber

## TURTLE-BACK II LAMPS



**Optic Lens**  
GR-46802 Red  
GR-46803 Amber



**Optic Lens Sealed**  
GR-46832 Red  
GR-46833 Amber



**Reflex Lens**  
GR-46862 Red  
GR-46863 Amber



**Reflex Lens Sealed**  
GR-46872 Red  
GR-46873 Amber



**Sealed  
Stop, Turn, Tail**  
GR-52772 Red  
GR-52922 Economy



**Sealed  
Stop, Turn, Tail (Male Pin)**  
GR-53102 Red  
GR-53103 Amber

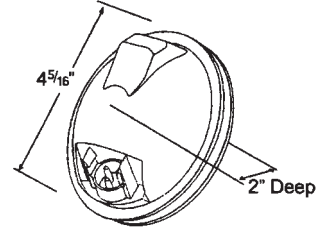

**Economy Steel Lamp  
Double Contact**  
GR-50232



**4" Combination  
Lamp with  
License Window**  
GR-50852



**3-Stud  
Peterbilt/Chev/GMC**  
GR-50972



**2-Stud  
Mack/Dodge**  
GR-50992



**Sentry Side Turn**  
GR-53163 Amber



**Oval Side Turn  
Marker Lamp Kit  
(Male Pin)**  
GR-52553 Amber



**Oval Side Turn  
Marker Lamp**  
GR-52513 Amber



**Oval Side Turn  
Marker Lamp  
(Male Pin)**  
GR-52533 Amber



**Oval  
Stop, Turn, Tail**  
GR-52892 Red



# Grote - Harnesses & Pigtails



**Rear Sill Harness**  
GR-66001



**Rear Sill Harness  
Repair Kit**  
GR-67040



**Male Pigtail**  
GR-66800  
With Ground



**Y Adapter Pigtail**  
GR-66810  
9"; Female-Pin Lamps



**Mid-Turn Adapter  
Pigtail**  
GR-66820  
Female-Pin Lamps



**Sentry Lamp Pigtail**  
GR-66900  
6"

## Turtle-Back II Lamp Pigtail



GR-67070



GR-67071



**3-Wire Pigtail**  
GR-67000  
11-1/2"

## 6" Turtle-Back II Lamp Pigtail



GR-66910



GR-66911



**3-Wire Pigtail**  
GR-67002  
11"; Male-Pin Lamps



**LED Pigtail**  
GR-66930



**I.D. Lamp Jumper**  
GR-66160

## Grote - Utility & License Lamps



**Die-Cast Utility Lamp**  
GR-60311  
Shallow; Clear



**Sealed License Lamp**  
GR-60191  
2"; With Mounting Bracket



**Turtle-Back II License Lamp**  
GR-60331



**License Lamp**  
GR-60001  
Gray

## Grote - Rubber Grommet

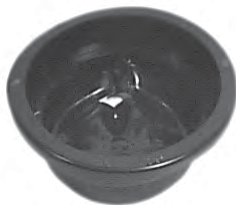

**Closed-Back Grommet**  
GR-91950  
For U.S. 40 Series Lamps

# Grote - Replacement Lenses



**Lens for 45262  
and 45263**

GR-90122 Red  
GR-90123 Amber



**Lens for 45442  
and 45462**

GR-90172 Red  
GR-90173 Amber



**Lens for 46792  
and 46793**

GR-91962 Red  
GR-91963 Amber



**Lens for 46302  
and 46312**

GR-91042 Red

**Lens for 46303  
and 46313**

GR-91043 Amber



**Lens for 45412  
and 45413**

GR-90162 Red



**Lens  
7" Arrow**  
GR-90103 Amber

## Oval Reflectors



**Steel 3"**

PM-460A  
PM-460R



**Aluminum 3"**

PM-472A  
PM-472R

## Center Mount Reflectors



**2-3/8"**

PM-477A  
PM-477R



**3-3/16"**

PM-476A  
PM-476R

## Stick-On Reflectors



**Round 2-3/8"**

PM-481A  
PM-481R



**Round Wide-Angle**

**2-7/8"**  
PM-490A  
PM-490R



**Round 3-3/16"**

PM-475A  
PM-475R



**Rectangular  
Wide-Angle**  
**4-5/16" X 1-11/16"**

PM-491A  
PM-491R

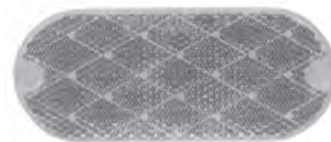

**Oblong**  
**4-3/8" X 1-7/8"**

PM-480A  
PM-480R

# Peterson - Marker Lamps



**Compact**  
PM-100A  
PM-100R  
PM-100-15A Lens Only  
PM-100-15R Lens Only



**Champion**  
PM-104A  
PM-104R  
PM-100-15A Lens Only  
PM-100-15R Lens Only



**Mini**  
PM-107WA  
PM-107WR  
PM-107-15A Lens Only  
PM-107-15R Lens Only

## Combination



**1-Bulb**  
PM-108WA  
PM-108WR  
PM-108-15A Lens Only  
PM-108-15R Lens Only



**2-Bulb**  
PM-106A  
PM-106R  
PM-108-15A Lens Only  
PM-108-15R Lens Only



**Hard-Hat 2-Bulb**  
PM-130A  
PM-130R  
PM-130-25A Lens Only  
PM-130-25R Lens Only



**Vanguard Armored**  
PM-124A  
PM-124R  
PM-124-15R Lens Only



**Vanguard II Armored**  
PM-122A  
PM-122R  
PM-124-15R Lens Only



**Steel Armored**  
PM-119A  
PM-119R



**Oblong 2-Bulb**  
PM-135A  
PM-135R  
PM-134-15A Lens Only  
PM-134-15R Lens Only



**Rectangular 2-Bulb**  
PM-138A  
PM-138R  
PM-138-15A Lens Only  
PM-138-15R Lens Only



**Piercing Point**  
PM-141A  
PM-141R  
PM-100-15A Lens Only  
PM-100-15R Lens Only

## Peterson - Marker Lamps



**Sealed 2"**  
PM-146A  
PM-146R



**Sealed 2-1/2"**  
PM-142A  
PM-142R



**Fruehauf  
Replacement**  
(Surface Mount)  
PM-96A  
PM-96R

## Peterson - Stop, Turn, Tail



**Sealed**  
PM-426A Lamp Only  
PM-426R Lamp Only



**428 Series**  
PM-428S w/o Illuminator  
PM-420-15 Lens Only



**Combination**  
PM-440 w/o Illuminator



**Module**  
PM-430L  
PM-430R  
PM-430-25 Lens Only  
PM-413-07 Pigtail Only

### Flush Mount

PM-413-3 w/ Reflector  
PM-413-S w/ Reflector; Stn Stl  
PM-410-15R Lens Only  
PM-410-21 Retainer Ring Only  
PM-413-07 Pigtail Only



## Peterson - License, Utility, Dome



**License**  
PM-436  
PM-436-01 Housing Only  
PM-436-25 Lens Only



**Tractor**  
PM-408  
LB-4411 Bulb Only



**Dome**  
PM-390S w/ Switch

# Peterson - Replacement Lenses



**Round**  
PM-100-15A  
PM-100-15R



**Mini-Lite**  
PM-107-15A  
PM-107-15R



**Oval**  
PM-108-15A  
PM-108-15R



**Armored**  
PM-124-15R



**Hard-Hat**  
PM-130-25A  
PM-130-25R



**Oblong**  
PM-134-15A  
PM-134-15R



**Module**  
PM-430-25



**428 Series**  
PM-420-15



**Back-Up**  
PM-414-15C



**Rectangular**  
PM-138-15A  
PM-138-15R



**Tail Light**  
PM-410-15A  
PM-410-15R  
PM-415-25R Lexan



**10" Pigtail**

PM-411-07 Single Wire  
PM-413-07 Double Wire



**Connector Plug**

PM-431-491



**Chrome Guard**

PM-106-09



**Identification - Red**

PM-107-3R



**O-Ring**

PM-139-18  
PM-95-18



**Snap Ring 4-1/4"**

PM-410-21  
PM-425S-21 Stn Stl



**Marker Lamp Base**

PM-1973

**Back-Up Lamp**

PM-411SC Stn Stl  
PM-414-15C Lens Only  
PM-411-07 Pigtail Only  
PM-425S-21 Snap Ring Only

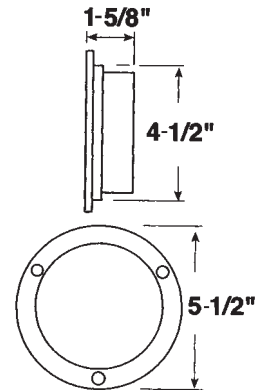

## Safe-T-Signal - Mid-Span Turn Signals



**Turn Arrow**

700-29-492  
Safe-T-Signal S-1800KIT

**8" Turn Arrow & Mounting Bracket**



700-29-493 LH  
Safe-T-Signal GL-202KIT

700-29-494 RH  
Safe-T-Signal GR-201KIT



# Truck-Lite - Reflectors



10

## Stick-On Reflectors



**Oblong Acrylic**  
TL-98001R  
TL-98001Y

**Oblong Polycarbonate**  
TL-98002R  
TL-98002Y



**Rectangular Acrylic**  
TL-98003R  
TL-98003Y

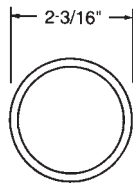

**2" Round Acrylic**  
TL-98008R  
TL-98008Y



**3" Round Acrylic**  
TL-98005R  
TL-98005Y



**Oval**  
TL-54 Red  
TL-54A Amber



**3" Round Retro-Reflective Tape**  
TL-98175Y

## Center-Mount Reflectors



**2" Round Acrylic**  
TL-98007R  
TL-98007Y

**3" Round Acrylic**  
TL-98006R  
TL-98006Y



**3" Round Aluminum Housing**  
TL-98030R  
TL-98030Y

10-12 Lights and Reflectors

## 2" LAMPS

### Grommet Mount Kit

- TL-30401 Kit (Open Back)
- TL-30402 Kit (Closed Back)
- TL-30700 Grommet (Open Back)
- TL-30702 Grommet (Closed Back)
- TL-94902 Plug Only



**Mounting Bracket**  
TL-30728

## Branch Deflector Mount Kits



### Adapter Mount Kit

- TL-30407 Kit
- TL-30701 Grommet Only
- TL-94902 Plug Only



### TL-30405 Kit

- TL-30722 Mount Only
- TL-30701 Grommet Only
- TL-94902 Plug Only



### TL-30404 Kit

- TL-30721 Mount Only
- TL-30700 Grommet Only
- TL-94902 Plug Only



### Cam-On Mount Kit

- TL-30403 Kit
- TL-00801 Mount Only



### Surface Mount Kit

- TL-30400 Kit
- TL-94902 Plug Only

## 2" & 2-1/2" LAMPS

### Cam-On Mount Kit

- TL-10410 Kit
- TL-10728 Mount Only (Gray)
- TL-10724 Mount Only (Gray; w/o Ribs)
- TL-10727 Mount Only (Clear; 8-1/2" Radius)
- TL-94924 Plug Only





# Truck-Lite - Mounting Accessories

## 2-1/2" LAMPS

### Grommet Mount Kit

- TL-10401 Kit (Open Back)
- TL-10402 Kit (Closed Back)
- TL-10700 Grommet (Open Back)
- TL-10702 Grommet (Closed Back)
- TL-94902 Plug Only



**Mounting Bracket**  
TL-10729

### Diaphragm Grommet Mount Kit

- TL-10403 Kit
- TL-10708 Grommet Only
- TL-94902 Plug Only



**Curved Mount Bracket**  
TL-10738 Bracket Only

### Surface Grommet Mount Kit

- TL-10412 Kit (Open Back)
- TL-10700 Grommet (Open Back)
- TL-10722 Surface Mount Only
- TL-94902 Plug Only

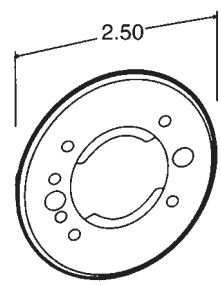

**Surface Mount**  
TL-10720  
Stainless Steel Mount Only

### Branch Deflector Mount Kit

- TL-10414 Kit
- TL-10725 Mount Only
- TL-10700 Grommet Only
- TL-94902 Plug Only



### 3" Grommet Mount Kit for 2-1/2" Lamps

- TL-10404 Kit
- TL-10704 Grommet Only
- TL-94902 Plug Only



## 4" LAMPS

### Grommet Mount Kit

TL-40403 Kit

TL-40700 Grommet Only

TL-94993 Plug Only



### Mounting Bracket

TL-40719 w/o Flange

TL-40720 w/ Flange



### Mounting Bracket

TL-40715

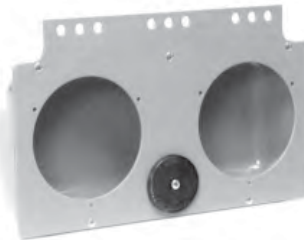

### Metal Module Box

TL-40725

## MODEL 14 LAMPS



### Grommet

TL-14700 White



# Truck-Lite - Mounting Accessories

## MODEL 15 LAMPS

### Rail Mount Kit

- TL-15414 Kit
- TL-15413 Kit w/ 94927 Plug
- TL-15727 Mount Only
- TL-15728 Cut Mount Only



**Grommet**  
TL-15702

### Branch Deflector Mount Kit

- TL-15401 Kit
- TL-96904 7" Hotwire



**License Lamp Bracket**  
TL-15729

## Adapter Mount Kits



- TL-15406 Kit (Gray)
- TL-15407 Kit (Chrome)
- TL-96904 7" Hotwire



- TL-15404 Kit (Gray)
- TL-15405 Kit (Chrome)

## MODEL 17 LAMPS



**License Lamp Bracket**  
TL-17720

## MODEL 19 LAMPS

### Base Mounts

- TL-19720 Base Only
- TL-19721 Base w/ Hot Wire
- TL-19722 Curved Base
- TL-96904 7" Hot Wire
- TL-96919 Hot Wire w/ Bullet



**Aluminum Lamp Guard**  
TL-19724

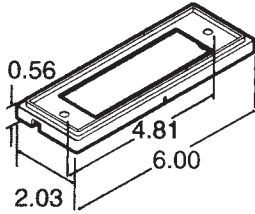

**Model 21  
Mounting Bracket**  
TL-21720



**Model 26  
Chrome  
Lamp Guard**  
TL-26720



**Model 35  
Armored  
Mounting Bracket**  
TL-35720



**Model 42  
License Plate Bracket**  
TL-42722



**Model 45  
Grommet**  
TL-45700

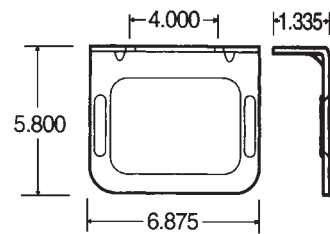

**Model 45  
Mounting Bracket**  
TL-45720

**Grommet Mount Kit  
for Oval Lamps**

- TL-60403 Kit
- TL-60700 Grommet
- TL-94993 Plug Only

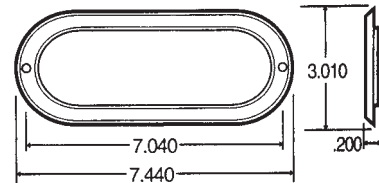

**Grommet Cover**  
TL-60703  
Stainless Steel

**Mounting Brackets for Oval Lamps**



- TL-60720 Stl; w/ Flange
- TL-60722 Stl; w/o Flange
- TL-60723 Alum; w/ Flange



**TL-60730**  
Stainless Steel



**Z Mounting Bracket**  
TL-60728

# Truck-Lite - Mounting Accessories



**I.D. Mounting Bracket**  
TL-00814



**Adapter Ring**  
TL-50831

# Truck-Lite - Sockets & Plugs



**I.D. Bar Harness**  
TL-93906 6" Centers  
TL-93908 9" Centers  
TL-93943  
6" Centers w/ .180 Bullet



**Model 44/60 LED Adapter Plug**  
TL-94706  
S/T/T/Mid-Turn  
TL-94789 Turn Signal



**Model 44/60 LED Plug Assembly**  
TL-94707  
S/T/T/Mid-Turn



**Pigtail - 48" Lead**  
TL-94811

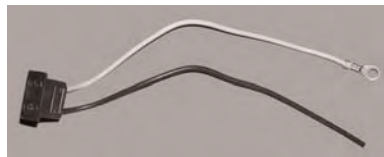

**19-Series Pigtail**  
TL-94729

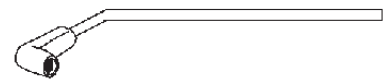

**License Lamp Plug**  
TL-94922



**Marker/Clearance Plug**  
TL-94924



**LED Marker/Clearance Plug**  
TL-94862



**LED Marker/Clearance Plug**  
TL-93745

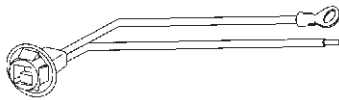

**Marker/Clearance Socket Assembly**  
TL-94940

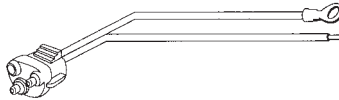

**Stop/Turn Plug**  
TL-94925 Single Contact  
TL-94926 Double Contact

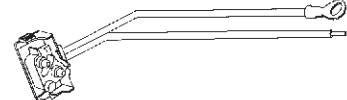

**Right Angle Stop/Turn Plug**  
TL-94992



**Stop/Turn/Tail Adapter Plug**  
TL-94932

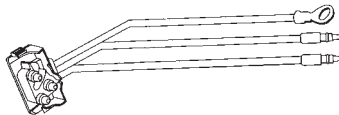

**Right Angle Stop/Turn/Tail Plug**  
TL-94931 48" Lead



**Socket Assembly w/ 1157 Bulb**  
TL-95407



**Universal 5-Wire Plug Assembly**  
TL-95000



**Hot Wires**

- TL-96932 5" w/ .180 Bullet
- TL-96904 7" Stripped
- TL-96919 7" w/ .180 Bullet
- TL-96930 12" Stripped



# Truck-Lite - Harness Systems



## 50 SERIES

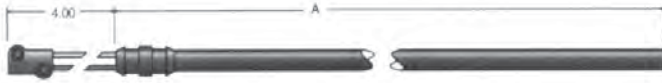

### Single-Plug Marker/Clearance Harness

TL-50303 A = 72"  
TL-50304 A = 168"



### 2-Plug Marker/Clearance Harness

TL-50309 A = 168"

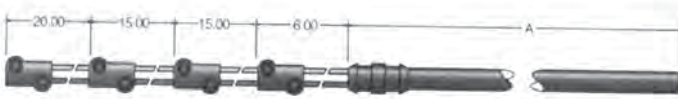

### Identification & License Lamp Harness

TL-50308 A = 36"



### 3-Plug Identification Harness

TL-50300 Lower; A = 36"  
TL-50301 Upper; A = 288"

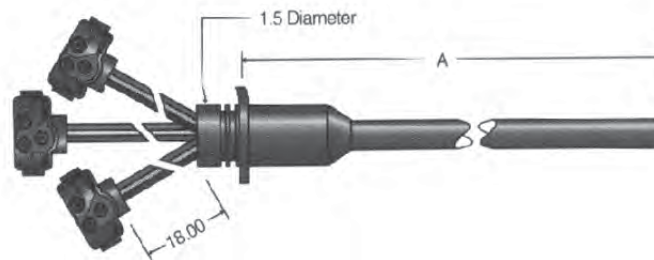

### Stop/Turn/Tail & Marker Harness

TL-50208 RH; A = 96"  
TL-50209 LH; A = 96"

### Stop/Turn/Tail & Back-Up Harness

TL-50251 RH; A = 144"  
TL-50250 LH; A = 144"

## 50 SERIES

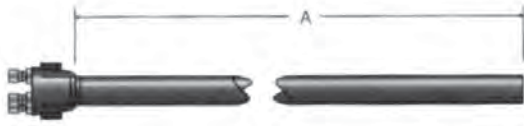

### Single-Plug Stop/Turn/Tail Harness

TL-50344 RH; A = 456"

TL-50345 LH; A = 456"

## 87 SERIES



### Stop/Turn/Tail & Side Marker Harness

TL-87208 A = 96"



### 4-Outlet Distribution Module

TL-87804

# Truck-Lite - Marker Lamps



10



## Model 10 LED Lamps

- TL-10050R Kit
- TL-10050Y Kit
- TL-10250R Lamp Only
- TL-10250Y Lamp Only
- TL-10275R Lamp Only
- TL-10275Y Lamp Only
- TL-10279Y Lamp Only;  
Flange Mount
- TL-10700 Grommet
- TL-94862 Plug Only



## Super 10 Lamps

- TL-10208R Lamp Only
- TL-10208Y Lamp Only
- TL-10212Y Lamp Only; ABS



## Model 10 Lamps

- TL-10202R Lamp Only
- TL-10202Y Lamp Only
- TL-10205R Lamp Only; w/ Reflector
- TL-10205Y Lamp Only; w/ Reflector



## Model 12 Deflector Mount

- TL-12003R Lamp w/ Gray Mount
- TL-12003Y Lamp w/ Gray Mount



## Model 14 Lamps w/ Reflector

- TL-14200R Lamp Only
- TL-14200Y Lamp Only

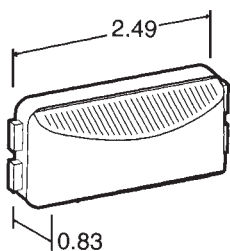

## Model 15 Lamps

- TL-15200R Lamp Only
- TL-15200Y Lamp Only



## Model 15 LED Lamps

- TL-15250R Lamp Only
- TL-15250Y Lamp Only

10-22 Lights and Reflectors

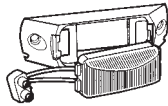

### Model 15 Header Mount

- TL-15008R Kit
- TL-15008Y Kit
- TL-15200R Lamp Only
- TL-15200Y Lamp Only
- TL-15728 Mount Only
- TL-94924 Plug Only

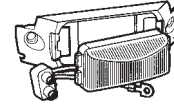

### Model 15 Rail Mount

- TL-15006R Kit
- TL-15006Y Kit
- TL-15200R Lamp Only
- TL-15200Y Lamp Only
- TL-15727 Mount Only
- TL-94924 Plug Only



### Model 15 Deflector Mount

- TL-15001R Kit
- TL-15001Y Kit
- TL-15200R Lamp Only
- TL-15200Y Lamp Only
- TL-96904 Plug Only



### Model 18 Lamp w/ Reflector

- TL-18300R Kit
- TL-18300Y Kit
- TL-94940 Plug Only



### Model 19 Lamps

- TL-19200R Lamp Only
- TL-19200Y Lamp Only



### Model 19 LED Lamps

- TL-19250R Lamp Only
- TL-19250Y Lamp Only



### Model 19 Gray Base Kit

- TL-19001R Kit
- TL-19001Y Kit
- TL-19200R Lamp Only
- TL-19200Y Lamp Only
- TL-19720 Base Only

### Model 19 Gray Base & Hot Wire Kit

- TL-19002R Kit
- TL-19002Y Kit
- TL-19200R Lamp Only
- TL-19200Y Lamp Only
- TL-19721 Base Only

# Truck-Lite - Marker Lamps



## Model 20 Beehive Lamp

- TL-20300Y Lamp
- TL-20304Y Lamp  
w/ Clearance Marker



## Super 21 Lamps

- TL-21200R Lamp Only
- TL-21200Y Lamp Only
- TL-21201R Lamp w/ Reflector
- TL-21201Y Lamp w/ Reflector

## Super 21 Lamp Kits



- TL-21001R Kit
- TL-21001Y Kit
- TL-21200R Lamp Only
- TL-21200Y Lamp Only
- TL-96930 Hot Wire Only

- TL-21002R Kit
- TL-21002Y Kit
- TL-21201R Lamp w/ Reflector
- TL-21201Y Lamp w/ Reflector
- TL-96930 Hot Wire Only



## Model 21 LED Lamps

- TL-21051R Kit
- TL-21051Y Kit
- TL-21251R Lamp Only
- TL-21251Y Lamp Only
- TL-94862 Plug Only
- TL-21880R Lamp Only; Diamond Shell
- TL-21880Y Lamp Only; Diamond Shell

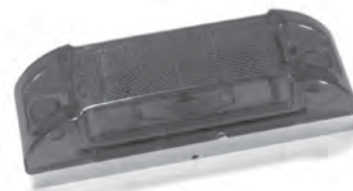

## Super 21 Extension Bracket

- TL-21501R Kit
- TL-21501Y Kit
- TL-21720 Extension Bracket Only



## Rectangular Die Cast Housing Replaces Model 26 26303 Series

- SS-1203 Red
- SS-1203A Amber



**2-Bulb Oval Lamp**  
**Replaces Model 26 26301 Series**

- SS-1259 Red
- SS-1259A Amber

**2-Bulb Oval Lamp**  
**Replaces Model 26 26304 Series**

- TL-1264 Red
- TL-1264A Amber

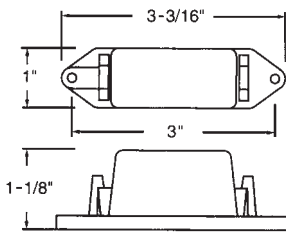

**Pee Wee Lamp**  
**Replaces Model 26 26306R**  
TL-1507 Red



**Model 26 Lamp**  
TL-26310R Lamp w/ Rubber Housing  
TL-26310Y Lamp w/ Rubber Housing



**Model 30 Lamps**  
TL-30200R Lamp Only  
TL-30200Y Lamp Only  
TL-30257Y Lamp Only; ABS



**Model 30 Grommet Mount**

- TL-30503R Kit
- TL-30503Y Kit
- TL-30200R Lamp Only
- TL-30200Y Lamp Only
- TL-30700 Grommet Only
- TL-94902 Plug Only



**Model 30 Flange Lamps**  
TL-30221R Lamp; Flush Mount  
TL-30221Y Lamp; Flush Mount  
TL-30222R Lamp; Surface Mount  
TL-30222Y Lamp; Surface Mount

# Truck-Lite - Marker Lamps



## Model 30 Beehive Lamp

TL-30201R Lamp Only  
TL-30201Y Lamp Only



## Model 30 LED Lamp Kits

TL-30050R Kit  
TL-30050Y Kit  
TL-30250R Lamp Only  
TL-30250Y Lamp Only  
TL-30700 Grommet Only  
TL-94862 Plug Only



## Model 30 LED Lamp

TL-30275Y Lamp Only

TL-30051R Flange Mount Kit  
TL-30051Y Flange Mount Kit  
TL-30251R Lamp w/ Flange



## Model 35 LED Lamp Kits

TL-35001R Kit  
TL-35001Y Kit  
TL-35080R Kit; Diamond Shell  
TL-35200R Lamp Only  
TL-35200Y Lamp Only  
TL-94862 Plug Only



## Rectangular Permastat Housing

SS-1211 Red  
SS-1211A Amber



### Model 40 Lamps

- TL-40202R Lamp Only
- TL-40202Y Lamp Only
- TL-40215R Lamp Only  
w/ Reflector
- TL-40209R Lamp Only, 24V
- TL-40222R Lamp Only w/ Flange
- TL-40206R Lamp Only; Clear Housing



### Model 40 Economy Lamp Kit

- TL-40028R Kit
- TL-40282R Lamp Only



### Model 40 Flange Mount Kit

- TL-40022R Kit
- TL-40222R Lamp Only w/ Flange
- TL-94993 Plug Only



### Model 40 Grommet Mount Kits

- TL-40002R Kit
- TL-40002Y Kit
- TL-40015R Kit w/ Reflector
- TL-40202R Lamp Only
- TL-40202Y Lamp Only
- TL-40215R Lamp Only w/ Reflector
- TL-40700 Grommet Only
- TL-94993 Plug Only



### Super 40 Grommet Mount Kits

- TL-40042R Kit
- TL-40042Y Kit
- TL-40048R Kit w/ Reflector
- TL-40242R Lamp Only
- TL-40242Y Lamp Only
- TL-40248R Lamp Only w/ Reflector
- TL-40700 Grommet Only
- TL-94993 Plug Only





### Super 40 Lamps

- TL-40242R Lamp Only
- TL-40242Y Lamp Only
- TL-40248R Lamp Only w/ Reflector



### Model 41 Lamp Kits

- TL-41005R Kit LH
- TL-41006R Kit RH
- TL-41007R Kit Universal
- TL-41202R Lamp Only LH
- TL-41203R Lamp Only RH
- TL-94926 Plug Only; Universal Kit



### Super 44 LED Lamp Kits

- TL-44032R Kit; Gray Flange
- TL-44036R Kit; Black Flange
- TL-44038R Kit; White Flange
- TL-44030R Kit; Grommet

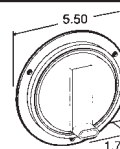

### Super 44 LED Lamps

- TL-44322R Gray Flange
- TL-44326R Black Flange
- TL-44328R White Flange
- TL-44302R Grommet
- TL-44705 LED Security Ring



### Super 45 Lamp Kits

- TL-45002R Kit
- TL-45002Y Kit
- TL-45202R Lamp Only
- TL-45202Y Lamp Only
- TL-45700 Grommet Only
- TL-94993 Plug Only



### Super 45 Lamps

- TL-45201R Lamp Only; Turn Signal
- TL-45201Y Lamp Only; Turn Signal
- TL-45202R Lamp Only
- TL-45202Y Lamp Only
- TL-45221Y Lamp Only; LLV



### Super 60 Lamp Kits

- TL-60002R Kit
- TL-60002Y Kit
- TL-60302R Kit
- TL-60202R Lamp Only
- TL-60202Y Lamp Only
- TL-60700 Grommet Only
- TL-94993 Plug Only



### Model 70 Pedestal Lamp

- TL-70311 Red/Amber

## MODEL 80 LAMPS



**TL-80302R** Black Housing  
**TL-99007R** Lens Only



**TL-80339R** Rubber Housing



**TL-80334R** Black Housing  
**TL-80335R** Stainless Steel Housing  
**TL-80336R** Polished Stainless Steel Housing



### Model 80 Multi-Function Lamp for GM

**TL-4018** RH  
**TL-4017** LH  
**TL-9071** Lens Only



### Super 82 Multi-Function

**TL-82030R** Kit RH  
**TL-82031R** Kit LH  
**TL-82300R** Lamp Only RH  
**TL-82301R** Lamp Only LH



### Multi-Function Lamps for Navistar

**TL-5315Y101** w/ License  
**TL-5316Y101** w/o License  
**TL-95000** Plug Only

# Truck-Lite - Modules



- TL-40742 Module LH
- TL-40743 Module RH
- TL-40202R Lamp Only
- TL-40700 Grommet Only
- TL-40722 Box Only



- TL-40746 Module LH
- TL-40747 Module RH
- TL-40202R Lamp Only
- TL-40700 Grommet Only
- TL-40722 Box Only



- TL-40756 Module LH
- TL-40757 Module RH
- TL-40202R Lamp Only
- TL-40700 Grommet Only
- TL-19200R Lamp Only



**Model 20 Side Turn Indicator**  
TL-20304Y



- Model 22 Lamp Kits**
- TL-22002Y Kit
  - TL-22004R Kit w/ Gasket
  - TL-22004Y Kit w/ Gasket
  - TL-22006Y Lamp & Gasket
  - TL-22202Y Lamp Only
  - TL-94993 Plug Only



- Model 40 Lamps**
- TL-40201R Lamp Only
  - TL-40201Y Lamp Only



- Model 60 Lamps**
- TL-60201R Lamp Only
  - TL-60201Y Lamp Only



- Model 60 Lamp Kit**
- TL-60015Y Kit
- TL-60215R Lamp Only
  - TL-60215Y Lamp Only
  - TL-60700 Grommet Only
  - TL-94993 Plug Only



- Model 60 LED Lamp Kits**
- TL-60072Y Kit; Flange Mount
  - TL-60075Y Kit; Grommet Mount
  - TL-60085R Kit; Diamond Shell
  - TL-60700 Grommet Only
  - TL-94706 Adapter Plug



- Model 60 LED Lamps**
- TL-60250R Lamp Only
  - TL-60275Y Lamp Only
  - TL-60315Y Lamp Only
  - TL-60280Y Lamp w/ Arrow
  - TL-60719 LED Security Ring

# Truck-Lite - Turn Signal Lamps

10



**Model 70 Pedestal Lamp**

TL-70300 Red/Amber



**Model 70 Lamp for Ford**

TL-70357 RH

TL-70356 LH



**7" Round Arrow**

TL-90325Y



**Model 40 Lamp Kit**

TL-40004 Kit

TL-40204 Lamp Only

TL-40700 Grommet Only

TL-94992 Plug Only



**Super 40 Lamp Kit**

TL-40044 Kit

TL-40244 Lamp Only

TL-40700 Grommet Only

TL-94992 Plug Only



**Model 60 Lamp Kit**

TL-60004C Kit

TL-60204C Lamp Only

TL-60700 Grommet Only

TL-94992 Plug Only

**Model 80 Bulb-Replaceable Lamps**

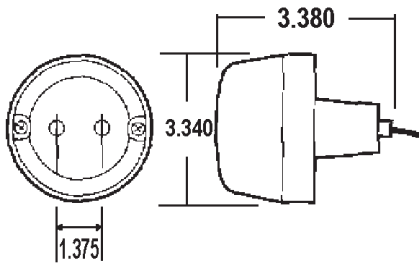

TL-80340



TL-80344 Stainless Steel Housing

# Truck-Lite - License Lamps



**Model 15  
Lamps**

TL-15200C Lamp Only  
TL-15208 Lamp Only



**Model 15  
Lamp Kit**

TL-15011 Kit  
TL-15208 Lamp Only  
TL-15729 Bracket Only



**Model 17  
Lamp Kits**

TL-17001 Kit  
w/ 90 Angle Hot Wire  
TL-17002 Kit  
w/ Straight Hot Wire  
TL-17200 Lamp Only



**Model 17  
Mounting Bracket**  
TL-17720



**Model 19  
Lamps**

TL-19200C Lamp Only  
TL-19206 Lamp Only



**Super 21  
Lamp Kit**

TL-21004C Kit  
TL-21204C Lamp Only  
TL-96930 Hot Wire Only

## Model 26 Lamps



TL-26330 Clear



TL-26331 Clear



TL-26335



**Model 42  
License Plate  
Bracket**  
TL-42722



**Model 10  
Lamp**  
TL-10202C



**Model 30  
Lamp**  
TL-30200C



**Model 40  
Dome Lamp Kit**  
TL-40023 Kit w/ Flange  
TL-40203 Lamp Only  
TL-94992 Plug Only

## Model 80 Dome Lamps



**5"**  
TL-80351 Chrome  
TL-80350 Chrome w/  
Switch

**7"**  
TL-80355 Chrome  
TL-80354 Chrome w/  
Switch

# Truck-Lite - Multi-Purpose Lamps

## Circular Rubber-Housed Lamps



**3000 CP**  
TL-80360 Clear  
TL-80361 Clear w/  
Lens Shield  
LB-4311-1 Bulb Only

**110,000 CP**  
TL-80374 Clear



## Rectangular Rubber-Housed Lamps

TL-80388 Clear w/  
Auxiliary Beam  
TL-80394 Clear w/  
Trapezoid Beam  
TL-80396 Clear w/  
Flood Beam  
TL-80397 Clear w/  
Spot Beam



# Truck-Lite - ID Bar Lamps



**Model 15  
Stainless Steel  
ID Bar**

TL-15741R Red; 6" Centers

## Metal ID Bars



**Model 10**

TL-10745R Red; 9" Centers  
TL-10744R Red; 6" Centers  
TL-00798 Bar Only; 6" Centers

**Model 30**

TL-30740R Red; 6" Centers  
TL-00798 Bar Only; 6" Centers



**3-Lamp Steel  
Mounting Bracket**  
TL-00814

Use Grommet Part Nos.  
TL-10404 & TL-10704

# Truck-Lite - Cab Marker Lamps



**Model 10**  
TL-10203R  
TL-10203Y



TL-26762Y

## Model 26



TL-26771Y

## Model 25



TL-26765Y Lamp  
TL-99067Y Lens Only  
TL-99067R Lens Only



**For Ford**  
TL-25760Y



**For Mack**  
TL-25761Y Lamp  
TL-07021 Lens Only

## Model 26



**Bulls-Eye Lens**  
TL-9007 Red  
TL-9007A Amber



**Oblong Lens**  
TL-9093 Red  
TL-9093A Amber



**Beehive Lens**  
TL-99039R



**Cab Marker Lens**  
TL-99067R  
TL-99067Y



**Cab Marker Lens**  
TL-99066Y

## Model 80



**Model 70  
4" Round Lens**  
TL-99090R  
TL-99090Y



**4" Round Lens**  
TL-99007R



**Multi-Function Lens**  
TL-99068R



**Tail Light Lens**  
TL-99077R



**Fruehauf  
Replacement Lens**  
SS-9075 Red



**Lenses for 1205 &  
1233 Lamps**  
SS-9077 Red  
SS-9077A Amber

# Truck-Lite - Miscellaneous

## Double-Face Turn Signals



**SS-3812**  
Red/Amber; Chrome Housing



**SS-5800AAK** Kit  
**SS-5800AA** Lamp Only



**5010 Series Connector**  
**SS-9464**

## Combination Lamps



**SS-5013** RH w/  
Illuminator  
**SS-5014** LH



**SS-5016** RH  
**SS-5015** LH



**Universal**  
**SS-4027D**



### **NYK-77 Compound**

**TL-97940** 8-oz Can  
**TL-97944** 2-oz Tube

## Sealed Marker Lamps



**1" X 2"**

UB-SE1225A Amber  
 UB-SE1225R Red  
 UB-SE1225C Clear  
 Replaces Truck-Lite 15200



**1" X 4"**

UB-SE1040A Amber  
 UB-SE1040R Red  
 Replaces Truck-Lite 19200

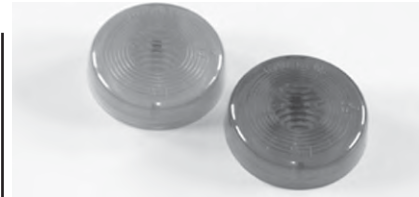

**2"**

UB-SE2000A Amber  
 UB-SE2000R Red  
 Replaces Truck-Lite 30200

## 2-1/2"



UB-SE2500A Amber  
 UB-SE2500R Red  
 Replaces Truck-Lite 10202

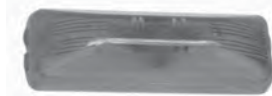

UB-SR2500A Amber  
 UB-SR2500R Red  
 Replaces Truck-Lite 10205

## LED Marker Lamps



**1" X 2"**

UB-LED1225A Amber  
 UB-LED1225R Red  
 Replaces Truck-Lite 15250



**1" X 4"**

UB-LED1040A Amber  
 UB-LED1040R Red  
 Replaces Truck-Lite 19250



**2"**

UB-LED2000A Amber  
 UB-LED2000R Red  
 Replaces Truck-Lite 30250



**2-1/2"**

UB-LED2500A Amber  
 UB-LED2500R Red  
 Replaces Truck-Lite 10250



**Bullseye  
 Marker Lamp**

UB-MLR2040A Amber  
 UB-MLR2040R Red  
 Replaces Truck-Lite 9007

# Uni-Bond - Stop, Turn, Tail



**4" Sealed**  
UB-SE4000A Amber  
UB-SE4000R Red  
Replaces Truck-Lite 40202



**4" Sealed**  
UB-SE4000W White  
Replaces Truck-Lite 40204



**4" LED (56-Diode)**  
UB-LED4000A Amber  
UB-LED4000R Red  
Replaces Truck-Lite 44202



**Oval Sealed**  
UB-SE2238A Amber  
UB-SE2238R Red  
Replaces Truck-Lite 60202

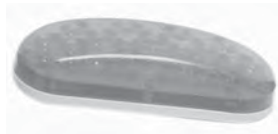

**Oval LED**  
UB-LED2238A Amber  
UB-LED2238R Red  
Replaces Truck-Lite  
60275Y & 60250R

## Uni-Bond Miscellaneous



**License Plate  
Lamp**  
UB-LP1002  
Replaces Truck-Lite 26335



**5" Rubber  
Work Lamp**  
UB-AX4411  
Replaces Truck-Lite 80360



**2" Grommet**  
UB-GR2000 Open Back  
Replaces Truck-Lite 30700  
UB-GR2001 Closed Back  
Replaces Truck-Lite 30702



**4" Grommet**  
UB-GR4000  
Replaces Truck-Lite 40700



**Oval Grommet**  
UB-GR2238  
Replaces 60700



**Metal Trailer Module**  
**UB-TM8050L**  
 Replaces Truck-Lite 40756  
**UB-TM8050R**  
 Replaces Truck-Lite 40757



**Mounting Bracket  
 w/ Hot Wire**  
**UB-BM1040B**  
 Replaces Truck-Lite 19721



**Right-Angle  
 Pigtail**  
**UB-PT6020**  
 Replaces Truck-Lite 94924  
**UB-PT9530**  
 Replaces Truck-Lite 94993

## CROSS REFERENCE from TRUCK-LITE to UNI-BOND GENERIC REPLACEMENT

TRUCK-LITE	UNI-BOND GENERIC REPLACEMENT				
	Amber	Red	Clear	White	Other
9007	UB-MLR2040A	UB-MLR2040R			
10202	UB-SE2500A	UB-SE2500R			
10250	UB-LED2500A	UB-LED2500R			
15200	UB-SE1225A	UB-SE1225R	UB-SE1225C		
15250	UB-LED1225A	UB-LED1225R			
19200	UB-SE1040A	UB-SE1040R			
19721					UB-BM1040B
26335					UB-LP1002
30200	UB-SE2000A	UB-SE2000R			
30250	UB-LED2000A	UB-LED2000R			
30700					UB-GR2000
30702					UB-GR2001
40202	UB-SE4000A	UB-SE4000R			
40204				UB-SE4000W	
40700					UB-GR4000
40756					UB-TM8050L
40757					UB-TM8050R
44202	UB-LED4000A	UB-LED4000R			
60202	UB-SE2238A	UB-SE2238R			
60250R		UB-LED2238R			
60275Y	UB-LED2238A				
60700					UB-GR2238
80360					UB-AX4411
94924					UB-PT6020
94993					UB-PT9530

<b>LOCK BOLTS &amp; COLLARS .....</b>	<b>11-1</b>
<b>CAMTAINERS, MONO BOLTS, &amp; POP RIVETS .....</b>	<b>11-2</b>
<b>BUCK RIVETS .....</b>	<b>11-3 TO 11-4</b>
<b>FLOOR SCREWS .....</b>	<b>11-4</b>
<b>NYLON RIVETS &amp; MISCELLANEOUS .....</b>	<b>11-5</b>

## LOCK BOLT PINS



Part No.	Dia.	Grip Range	Cross Reference
50-B18P-24C	1/4"	3/16" - 5/16"	C6LB-R8-4G
50-B18P-26C		5/16" - 7/16"	C6LB-R8-6G
50-B18P-74C	3/8"	1/8" - 3/8"	C6LB-R12-4G
50-B18P-76C		1/4" - 1/2"	C6LB-R12-6G
50-B18P-78C		3/8" - 5/8"	C6LB-R12-8G

## LOCK BOLT COLLARS



Part No.	Dia.	Cross Reference
50-B18K-2C	1/4"	2LC-R8G
50-B18K-3C	5/16"	2LC-R10G
50-B18K-4C	3/8"	2LC-R12G

## MAGNA-GRIP LOCK BOLT PINS

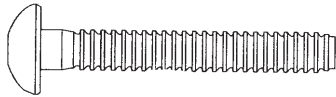

Part No.	Dia.	Grip Range	Head Style	Cross Reference
50-B18Q-7	1/4"	1/8" - 3/4"	Button	MGPB-R8-10G
50-18Z-515		5/8" - 1-1/2"	Broad Truss	MGP30-R8-24G
50-B18Q-19	3/8"	1/16" - 5/8"	Button	MGPB-R12-14G
50-18Z-516		5/8" - 1-1/2"	Broad Truss	MGP30-R12-24G

## MAGNA-GRIP COLLARS

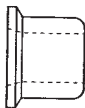

Part No.	Dia.	Cross Reference
50-B18K-45	1/4"	MGC-R8U
50-B18K-40	3/8"	MGC-R12U

## HUCKTAINER PINS (GRAY HEAD)

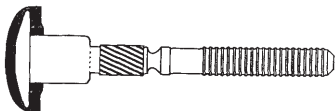

Part No.	Dia.	Grip Range	Cross Reference
50-18Z-553	3/8"	.937 - 1.062	HLPMPG-R12-16
50-18Z-552		1.062 - 1.187	HLPMPG-R12-18

## HUCKTAINER COLLARS



Part No.	Dia.	Head Dia.	Cross Reference
50-18Z-548	3/8"	0.63	HLPSC-R12
50-18Z-549		1.16	HLPS-R12



# Camtainers, Mono Bolts, Pop Rivets



## CAMTAINER I BOLTS

Part No.	Dia.	Length	Head Style	Head O.D.
CT-395-8149	5/16"	7/8"	Std Head	0.89
CT-395-8152		1"		



## CAMTAINER II BOLTS

Part No.	Dia.	Length	Head Style	Head O.D.	Head Color
CT-395-8166	5/16"	7/8"	Std Head	1.00	Gray
CT-395-8155					White

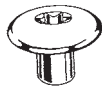

## CAMTAINER NUTS

Part No.	Dia.	Length	Head Style	Head O.D.	Torx Drive
CT-396-8006	5/16"	3/8"	Std Head	1.00	T55
CT-396-8002		1/2"			
CT-396-8003		5/8"			



## MONO BOLTS

Part No.	Dia.	Material	Grip Range	Cross Reference
700-50-28	1/4"	Aluminum	.080 - .375	BAPV 86
700-50-29			.350 - .625	BAPV 810
700-50-30		Steel	.080 - .375	SSPV 86
700-50-31			.350 - .625	SSPV 810
50-18Z-487		Stainless Steel	.080 - .375	CCPV 86



## PROTRUDING HEAD "N" RIVETS (STEEL PIN)

Part No.	Dia.	Material	Grip Range	Cross Reference
700-50-21	1/4"	Steel	.251 - .375	SSP86
700-50-22			.376 - .500	SSP88
700-50-23			.626 - .750	SSP812
700-50-24			.876 - 1.00	SSP816



## LARGE FLANGE "N" RIVETS (STEEL PIN)

Part No.	Dia.	Material	Grip Range	Cross Reference
700-50-19	3/16"	Aluminum	.376 - .500	BSL68
700-50-20			.626 - .750	BSL612



## AVEX RIVETS (STEEL PIN)

Part No.	Dia.	Material	Grip Range	Cross Reference
700-50-44	3/16"	Aluminum	.062 - .250	1610-3722
700-50-49			.187 - .437	1610-3716

## 3/16" BRAZIER HEAD ALUMINUM (Hard Alloy 2117-T4)

Part No. - 5 Lbs	Part No. - 1 Lb.	Size	Approx Pcs Per Lb
50-18P-5	---	3/16" X 5/16"	576
50-18Z-260	50-18Z-260-PK	3/16" X 3/8"	523
50-18Z-261	50-18Z-261-PK	3/16" X 7/16"	480
50-18P-8	50-18P-8-PK	3/16" X 1/2"	443
50-18P-9	---	3/16" X 9/16"	411
50-18P-10	50-18P-10-PK	3/16" X 5/8"	384
50-18P-12	---	3/16" X 3/4"	338



## 3/16" BRAZIER HEAD ALUMINUM (Soft Alloy 1100F)

Part No. - 5 Lbs	Part No. - 1 Lb.	Size	Approx Pcs Per Lb
700-50-56	700-50-56-PK	3/16" X 3/8"	523
700-50-57	700-50-57-PK	3/16" X 7/16"	480
700-50-58	700-50-58-PK	3/16" X 1/2"	443
700-50-60	---	3/16" X 5/8"	384

## 3/16" BRAZIER HEAD STAINLESS STEEL

Part No. - 1 Lb.	Size	Approx Pcs Per Lb
50-18U-3S	3/16" X 3/8"	196

## 3/16" UNIVERSAL HEAD ALUMINUM (Hard Alloy 2117-T4)

700-50-37	---	3/16" X 3/8"	633
700-50-38	---	3/16" X 7/16"	571
700-50-39	---	3/16" X 1/2"	521
700-50-40	---	3/16" X 5/8"	441



## 1/4" BRAZIER HEAD ALUMINUM (Hard Alloy 2117-T4)

Part No. - 5 Lbs	Part No. - 1 Lb.	Size	Approx Pcs Per Lb
50-18P-19	---	1/4" X 3/8"	257
50-18P-20	---	1/4" X 7/16"	238
50-18P-21	50-18P-21-PK	1/4" X 1/2"	222
50-18P-22	---	1/4" X 9/16"	207
50-18P-23	50-18P-23-PK	1/4" X 5/8"	195
50-18P-25	50-18P-25-PK	1/4" X 3/4"	174



# Buck Rivets

11

## 1/4" MODIFIED BRAZIER HEAD ALUMINUM (Hard Alloy 2117-T4)



Part No. - 5 Lbs	Part No. - 1 Lb.	Size	Approx Pcs Per Lb
50-18M-19	---	1/4" X 3/8"	369
50-18M-20	---	1/4" X 7/16"	331
50-18M-21	50-18M-21-PK	1/4" X 1/2"	300
50-18M-22	---	1/4" X 9/16"	274
50-18M-23	50-18M-23-PK	1/4" X 5/8"	253
50-18M-25	---	1/4" X 3/4"	218

## 5/16" MODIFIED BRAZIER HEAD ALUMINUM (Hard Alloy 2117-T4)



Part No. - 5 Lbs	Part No. - 1 Lb.	Size	Approx Pcs Per Lb
50-18M-45	---	5/16" X 1/2"	169

## 5/16" MODIFIED BRAZIER HEAD STEEL

Part No. - Each	Size
50-18T-47C	5/16" x 5/8"

## 3/8" UNIVERSAL HEAD ALUMINUM (Hard Alloy 2117-T4)



Part No. - 5 Lbs	Part No. - 1 Lb.	Size	Approx Pcs Per Lb
50-18Z-507-10	---	3/8" X 5/8"	92
50-18Z-507-12	50-18Z-507-12-PK	3/8" X 3/4"	81
50-18Z-507-14	50-18Z-507-14-PK	3/8" X 7/8"	73

## Floor Screws

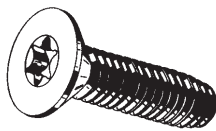

### TORX FLAT HEAD "TAP FORM"

Part No.	Size	Box Quantity
700-50-61	1/4"-20 X 1-1/2"	2000
50-19X-226	1/4"-20 X 2"	
50-19X-227	1/4"-20 X 2-1/2"	1000
50-19X-228	1/4"-20 X 3"	
50-19X-231	5/16"-18 X 2"	
50-19X-232	5/16"-18 X 2-1/2"	

### TORX FLAT HEAD "TYPE F"

Part No.	Size	Box Quantity
50-19X-163P-32	1/4"-20 X 4"	1500
50-19X-163P-40	1/4"-20 X 5"	1000
50-19X-163P-48	1/4"-20 X 6"	

## NYLON TAPITS TRUSS HEAD

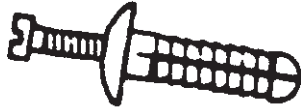

Part No.	Diameter	Length
50-D18A-2	1/4"	3/4"
50-D18A-1		1"
50-D18A-19		1-1/2"
50-D18A-10		2"
50-D18A-20		3"

## NYLON UNI-TAP

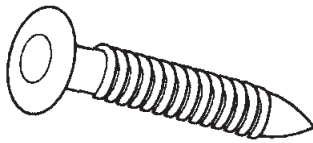

Part No.	Diameter	Length
50-D18A-34	1/4"	1"
50-D18A-36		1-5/8"

## EZ-IN / EZ-OUT FASTENERS

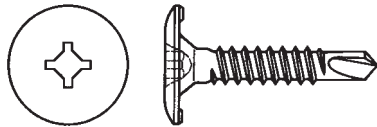

Part No.	Size	Application
700-50-50	#10 X 3/4"	Plywood
700-50-51	#10 X 1"	
700-50-52	#10 X 1-1/4"	
700-50-53	#12 X 1-1/4" Black	Scuff

Grip Range  
.275 - .375

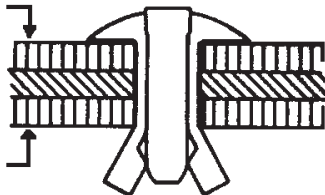

## 3/16" Plywood Drive Rivet (Aluminum)

50-C18J-3

Grip Range .275 - .375  
Southco 11-13-706-13  
Cherry 4145-6-375

<b>MUD FLAPS</b> .....	<b>12-1</b>
<b>MUD FLAP BRACKETS</b> .....	<b>12-2 TO 12-4</b>
<b>TRACTOR &amp; TANKER FENDERS</b> .....	<b>12-5 TO 12-6</b>
<b>DOCK BUMPERS &amp; WHEEL CHOCKS</b> .....	<b>12-7</b>
<b>FIRE EXTINGUISHERS</b> .....	<b>12-8</b>
<b>MIRRORS</b> .....	<b>12-8 TO 12-9</b>
<b>PLACARDS &amp; DECALS</b> .....	<b>12-10 TO 12-11</b>
<b>WIPER BLADES</b> .....	<b>12-12 TO 12-13</b>
<b>TIRE CHAINS</b> .....	<b>12-14</b>
<b>CONSPICUITY TAPE</b> .....	<b>12-14</b>
<b>TIRE CARRIERS</b> .....	<b>12-15</b>
<b>BACK-UP ALARMS</b> .....	<b>12-15</b>
<b>FUSEES, TRIANGLE KIT</b> .....	<b>12-15</b>
<b>FIRST AID KIT, DUPLICATE LOG BOOK, MISCELLANEOUS</b> .....	<b>12-15</b>



**w/ American Flag**

- 700-522-43-B 24 X 30"
- 700-522-43-C 24 X 36"

**3/16" White Plastic**

**Plain**

- 700-522-7-A 24 X 24"
- 700-522-7-B 24 X 30"
- 700-522-7-C 24 X 36"



**w/ TM Logo**

- 700-522-3-B 24 X 30"
- 700-522-3-C 24 X 36"

**3/16" Yellow Plastic**



- 700-522-34-B  
24" X 30"

**1/4" White Plastic w/ Vertical Grooves on Back for Water Dispersement**

**Plain**

- 700-522-32-A 24 X 24"
- 700-522-32-B 24 X 30"
- 700-522-32-C 24 X 36"



**w/TM Logo**

- 700-522-33-B 24 X 30"
- 700-522-33-C 24 X 36"

**1/4" Black Rubber**

**3/16" Plain Black Plastic**

- 700-522-27-A 24 X 24"
- 700-522-27-B 24 X 30"
- 700-522-27-C 24 X 36"

**Plain**

- 700-522-4-A 24 X 24"
- 700-522-4-B 24 X 30"
- 700-522-4-C 24 X 36"



**w/ TM Logo**

- 700-522-2-B 24" X 30"

**1/2" Heavy Duty Plain Black Rubber**

**1/4" Plain Black Plastic w/ Vertical Grooves on Back for Water Dispersement**

- 700-522-37-B 24 X 30"
- 700-522-37-C 24 X 36"



**No Sail**

- 700-522-42-B 24 X 30
- 700-522-42-C 24 X 36



**Anti-Spray**

- 700-522-36-B 24 X 30"
- 700-522-36-C 24 X 36"

# Mud Flap Brackets



**B23**

BE-B-23S Set

BE-A-23L Replacement Arm LH

BE-A-23R Replacement Arm RH



**B25**

BE-B-25S Set

BE-A-25R/L Replacement Arms



**B21**

BE-B-21 Set



**B29**

BE-B-29S Set

BE-A-29L Replacement Arm LH

BE-A-29R Replacement Arm RH



**B33**

BE-B-33S Set

BE-A-33L Replacement Arm LH

BE-A-33R Replacement Arm RH



**B35**

BE-B-35S Set

BE-A-35R/L Replacement Arms



**B39**

BE-B-39S Set



**B87**

BE-B-87 Set



**B83 Heavy Duty**  
BE-B-83HD Set



**B84 Heavy Duty**  
BE-B-84HD Set



**B57**  
BE-B-57NT  
Spring-loaded Bracket  
BE-B-57

Spring-loaded Bracket w/ reflective tape



**B67**  
BE-B-67NT  
Spring-loaded Bracket

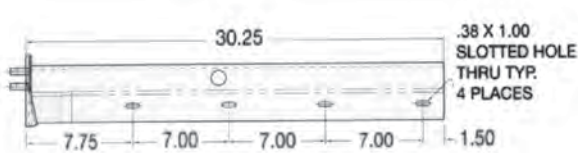

**FB-27**  
700-522-14  
Replaces 033-00868

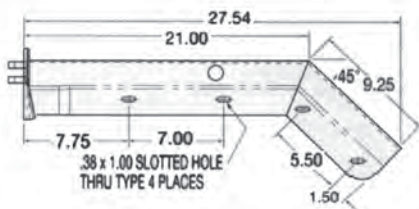

**FB-27 "Shortie"**  
700-522-31  
Replaces 033-00864



# Mud Flap Brackets

## Mounting Brackets



**BE-B-711**

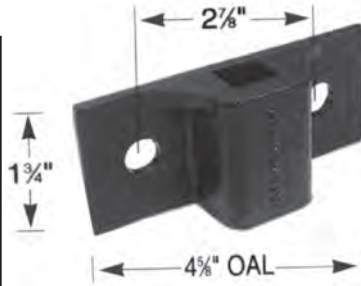

**BE-B-1732**



### Mounting Bracket Kit

**BE-K-1732**

Includes 2 B1732 Brackets



### Mounting Angle

**700-522-13**

2" X 2" X 27-1/2"



### Retaining Strap

**700-522-19**

2" X 24"

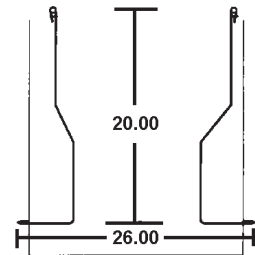

### Anti-Sail Bracket

**700-522-12** Black Primed

**700-522-28** Stainless Steel

## Stn Steel Flap Plate Kits (Mirror Finish)

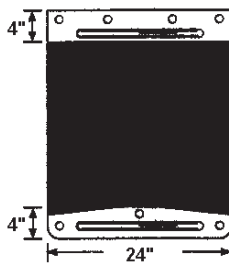

**700-522-15**

2 Upper & 2 Lower Plates;  
Stn Steel Mounting Hardware



**700-522-23**

2 Lower Plates;  
Stn Steel Mounting Hardware

## Trailmobile Splash Guard Mounting Brackets



**522-5-234L-1** LH

**522-5-234R-1** RH

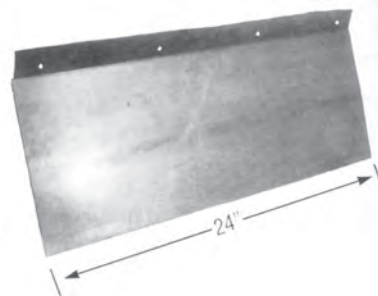

**522-5-216**

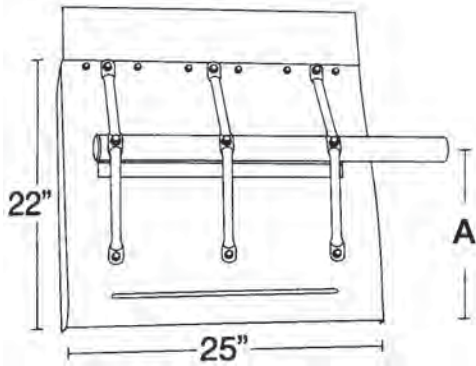

## Quarter Fenders & Mounting Brackets

Mounting Hardware Sold Separately

Part No.	Finish	A
FL-1580FB-KIT	Aluminum	13-1/2"
FL-1580LM-KIT		17-1/2"
FL-1585FB-KIT	Stainless Steel	13-1/2"
FL-1590FB-KIT	Painted Steel	

## Quarter Fender Mounting Kits

Mounting Hardware is for 1 Pair of Fenders

Item No.	Part No.	Description
1	FL-1590-12	Cross Bar Mounting Hardware
2	FL-1600-11M	Std Flange Mount Bracket 8"
3	FL-1600-15M	Single Post Mount 8" Pipe

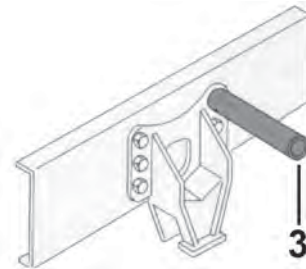
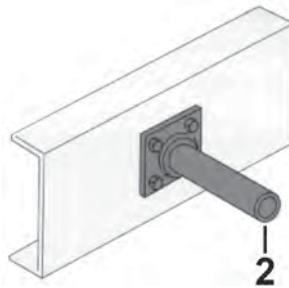
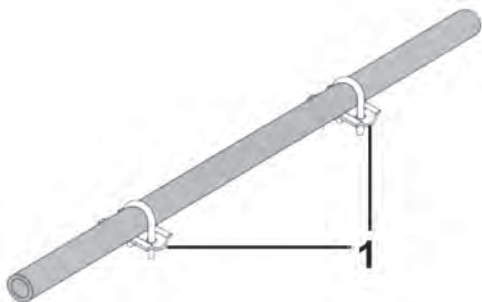

### Quarter Fender Flap

700-99-167

Plain Black Rubber; 6" X 24"



### Quarter Fender Kit

700-99-447

Black Poly

# Tractor & Tanker Fenders

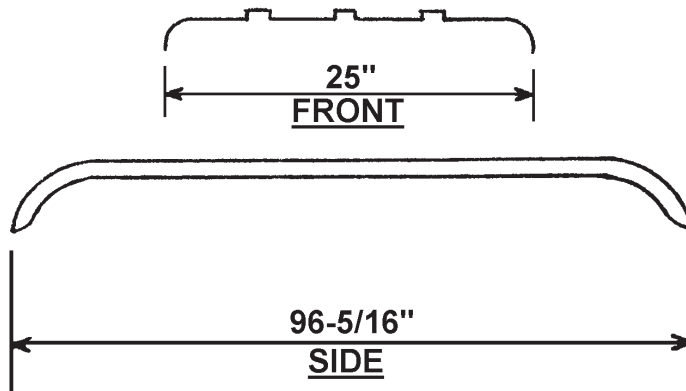

**Universal Rear Fender  
(Tandem)**  
700-99-195  
.090 Aluminum

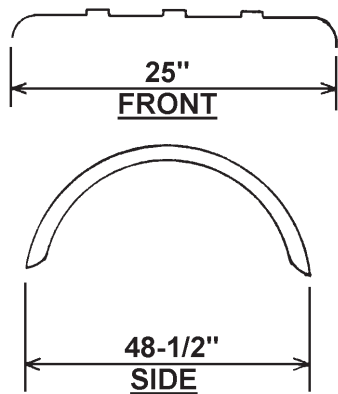

**Universal Rear Fender  
(Single)**  
700-99-196  
.090 Aluminum

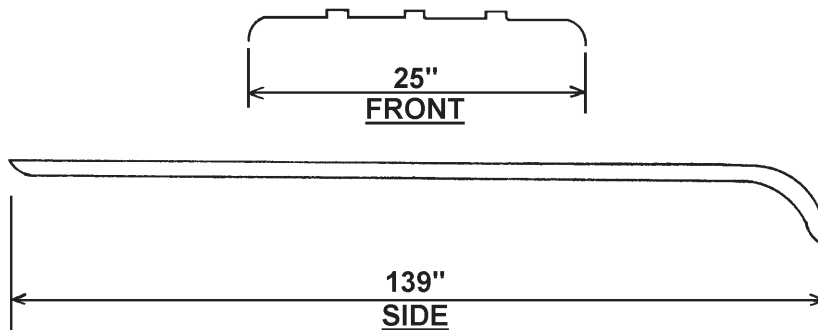

**Universal Front Fender**  
700-99-194  
.090 Aluminum

# Dock Bumpers & Wheel Chocks

## Rubber Dock Bumpers



**11-1-176**

Width	Height	Thickness	Hole Centers
4"	6"	3-1/4" to 2-1/2"	2-5/8"



**11-1-248**

Width	Height	Thickness	Hole Centers
2-3/4"	6"	3-1/4"	2-5/8"



**11-1-305**

Width	Height	Thickness	Hole Centers
3-1/2"	6"	3-1/4"	2-5/8"



**11-1-326**

Width	Height	Thickness	Hole Centers
2-1/2"	7-7/8"	2"	4-1/2"



**11-1-369**

Width	Height	Thickness	Hole Centers
3-3/4"	5-3/4"	4-1/2"	3-1/2"



**11-A1-113**

Width	Height	Thickness	Stud Centers
2-3/8"	6"	3-3/4"	3-1/2"



**700-99-484**

Width	Height	Thickness	Hole Centers
6"	8"	3"	3-1/8"W X 5-3/8"H



## Rubber Wheel Chock

**700-99-71**

8" Wide X 10" Long X 5-1/2" High

# Fire Extinguishers



## Fire Extinguishers w/ Mounting Bracket; D.O.T. Approved

Part No	Rating	Rating Detail	Disposable / Rechargeable	Chemical Weight	Type Valve or Nozzle
700-99-248	BC	5 B:C	Disposable	2 Lbs	Plastic Valve
700-99-249				2-3/4 Lbs	Aluminum Valve
700-99-250		10 B:C	Rechargeable	4 Lbs	Plastic Valve
700-99-251				5 Lbs	Plastic Nozzle
700-99-252	ABC	3 A-40 B:C			



700-99-248



700-99-249



700-99-250



700-99-251



700-99-252

## Mirrors



### Stick-On Spot Mirror

700-99-216 3"

700-99-217 3-3/4"

## 5" Convex w/ Universal Mounting Kit



### Black Steel

700-99-221

### Stainless Steel

700-99-222

## 7-1/2" Convex Stainless Steel w/ L-Bracket



**6" Convex  
Stainless Steel**  
700-99-246  
w/ L-Bracket



**Center Stud**  
700-99-245



**Offset Stud**  
700-99-227  
Generic UB-CX755SS

## 8-1/2" Convex w/ L-Bracket



**Black Steel**  
700-99-218

TL-97804  
Truck-Lite



**Stainless Steel**  
700-99-224  
Generic UB-CX850SS

## 7" X 16" West Coast



**Stainless Steel  
Heated**  
700-99-225  
w/ 60" Wire Lead

**Heated & Lighted**  
700-99-242  
w/ 60" Wire Lead



**Black Steel  
Ribbed Back**  
700-99-219

## 6" X 16" West Coast



**Aluminum**  
700-99-223  
Generic UB-WC6160AL



**Stainless Steel**  
700-99-220



**Universal  
Mounting Kit**  
700-99-228  
Zinc Plated;  
For 3/4" or 5/8" Tube

# Placards & Decals



## Flip Placards



Part No	Frame	Placards
700-99-404	White Aluminum	Dangerous; Flammable Gas 2; Non Flammable Gas 2; Flammable 3; Oxidizer 5.1; Poison 6; Inhalation Hazard 6; Corrosive 8; Blank
LM-81-8FO	Aluminum	Dangerous; Flammable Gas 2; Non Flammable Gas 2; Flammable 3; Oxidizer 5.1; Poison 6; Radioactive 7; Corrosive 8, Blank
LM-81-8SFO	Aluminum Split Frame	
LM-81-8WFO	White Aluminum	
LM-81-ACFO	Aluminum	Dangerous; Flammable 3; Oxidizer 5.1; Poison 6; Corrosive 8; Blank
LM-97-14WAF	White w/ 2 Clipped Corners	Explosives 1.4; Flammable Gas 2; Flammable 3; Flammable Solid 4; Dangerous When Wet 4; Organic Peroxide 5.2; Inhalation Hazard 6; Corrosive 8; Blank
LM-126CT	Aluminum Duo-Flip	Combustible 3; Flammable 3; Poison 6; Corrosive 8; Blank
LM-126CLR *	Aluminum	

\* Meets Canadian Clear Language Regulations



**Warning Decal**  
700-99-497



**Caution Decal**  
LM-RT14 13-1/2" X 10-3/4"  
LM-RT18 18" X 14"



**FHWA Decal and Inspection Form**  
33-1-228 Decal  
33-1-228A Form



**Slidemaster  
Placard Holder**

**Aluminum**  
LM-80SM97

LM-80SM/S97 Split Frame



**Placard Holder**

**Aluminum**  
700-99-281



**Placard Holder**

**Poly**  
700-99-500 Gray  
700-99-501 White



**Slidemaster  
Frame Only**  
LM-80SM-01



**Placard Clip**  
LM-81-CLIP-1  
Stainless Steel

**Mesh Banner  
Oversize Load**

700-99-504  
Yellow; 7' X 18"

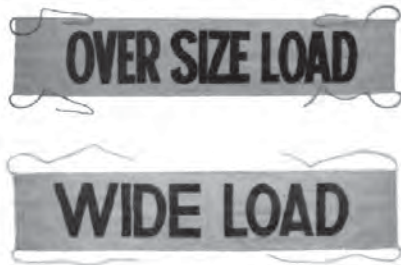

**Two-Sided Banner**

700-99-262  
Yellow; 7' X 18"

**Mesh Banner  
Wide Load**

700-99-505  
Yellow; 7' X 18"

**18" X 18" Red Mesh Flag**





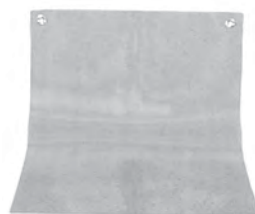



**w/ Wooden Dowel**  
700-99-263



**w/ Grommets**  
700-99-264



# Wiper Blades

<b>Trico II Exact Fit Blades</b>	Part No	Size
	TB-14-2	14"
	TB-16-2	16"
	TB-18-1	18"
	TB-18-2	
	TB-20-1	20"
	TB-20-2	

<b>61 Series for Flat Windshields</b>	Part No	Length	Finish
	TB-61-130	13"	Silver
	TB-61-140	14"	
	TB-61-150	15"	Black
	TB-61-151		
	TB-61-180	18"	Silver

<b>63 Series for Curved Windshields</b>	Part No	Length	Finish
	TB-63-140	14"	Silver
	TB-63-151	15"	Black
	TB-63-180	18"	Silver
	TB-63-181		Black

<b>65 Series for Curved Windshields</b>	Part No	Length	Finish
	TB-65-200	20"	Silver

<b>37 Series - Winter Blades</b>	Part No	Size
	TB-37-131	13"
	TB-37-160	16"
	TB-37-180	18"
	TB-37-189	
	TB-37-201	20"
	TB-37-209	
	TB-37-220	22"
	TB-37-240	24"

<b>66 Series - Heavy Duty Winter Blades</b>	Part No	Length
	TB-66-150	15"

# Tire Chains



## Road Blazer Cam Chains (Packed 1 pair per bag)

Part No.	Application	Tire Size
QC-2245QC	Single Tire	10.00R20; 11R22.5; 275/80R24.5; 275/80R22.5
QC-2247QC		295/75R22.5; 275/80R24.5; 285/75R24.5
QC-2249QC		10.00R22; 11R24.5; 285/75R24.5; 285/80R24.5

# Conspicuity Tape

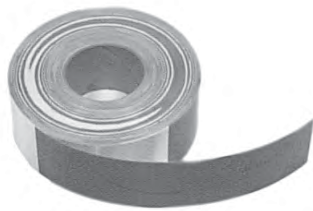

## 3M ROLLS

Part No	Pattern	Dimensions	Comment	Warranty
3M-983-02	11" Red / 7" White	2" X 150'		7-Yr
3M-983-02-KC			Kiss-Cut	
3M-985-05	6" White			3-Yr

## 3M KITS (3-Yr Warranty)

Part No	Trailer Length	2" X 18" Strip 980-32 11" Red / 7" White	2" X 12" Strip 980-10 Solid White	2" X 102" Strip 980-32 11" Red / 7" White	2" X 60" Strip 980-32 11" Red / 7" White	Squeegee and Instructions
3M-980-KIT53	53'	36	4	1	1	1
3M-980-KIT48	48'	32				

## REFLEXITE ROLLS

Part No	Pattern	Dimensions	Warranty
700-29-01	11" Red / 7" White	2" X 50'	7-Yr
700-29-02		2" X 150'	7-Yr
700-29-05			3-Yr
700-29-03	White	2" X 50'	7-Yr
700-29-06		2" X 150'	3-Yr

## REFLEXITE STRIPS

Part No	Description	Dimensions	Warranty
700-29-07	w/ Pre-mask	2" X 94"	3-Yr
700-29-08	Red / White	2" X 18"	
700-29-04			7-Yr
700-29-09	White	2" X 12"	3-Yr

## REFLEXITE KITS (7-Yr Warranty)

Part No	Trailer Length	2" X 18" Strip 11" Red / 7" White	2" X 12" Strip Solid White	Squeegee and Instructions
700-29-KIT53	53'	49	4	1
700-29-KIT48	48'	45		

## Tire Carriers (for tire sizes to 11.00 X 22")



**Universal**  
(w/ Mounting Hardware)  
700-14-5

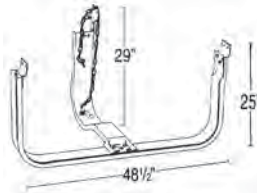

**Nash Style**  
(w/o Mounting Hardware)  
700-14-3

700-99-4 Mounting Hardware



**Steel Safety Deck**  
700-99-103

1-1/8" X 23-3/4" X 33-3/4";  
Galvanized; w/ Mounting  
Hardware

## Back-Up Alarms



**97 DB, 12V**  
700-99-258



**107 DB, 12-36V**  
700-99-259



**Triangle Kit**  
700-99-15  
Kit includes 3 Triangles

## Fuses



### 20-Minute

- 50-79-9               w/ Spike
- 700-99-141       w/o Spike
- 700-99-461       w/ Wire Stand

### 30-Minute

- 700-99-459       w/ Spike
- 700-99-460       w/o Spike
- 700-99-462       w/ Wire Stand



**First Aid Kit**  
700-99-521

Contains:

- 2 Antibiotic Ointment Packs
- 4 Extra Strength Non-Aspirin Tablets
- 2 Ibuprofen Tablets
- 2 Decongestant Tablets
- 6 Alcohol Cleansing Pads
- 6 Antiseptic Cleansing Wipes (sting free)
- 10 3/4" X 3" Adhesive Plastic Bandages
- 1 2" X 4" Elbow & Knee Plastic Bandage
- 10 3/8" X 1-1/2" Junior Plastic Bandages
- 2 Large Butterfly Wound Closures



**2004 Duplicate Log Book**  
700-99-511

- 1 Knuckle Fabric Bandage
- 1 Large Fingertip Fabric Bandage
- 1 First Aid Guide
- 2 Exam Quality Vinyl Gloves
- 1 Medium Safety Pin

<b>LOGISTIC TRACK</b> .....	<b>13-1</b>
<b>DECKING / SHORING BEAMS</b> .....	<b>13-1 TO 13-2</b>
<b>LOAD LOCKS</b> .....	<b>13-2 TO 13-3</b>
<b>LOGISTIC STRAPS</b> .....	<b>13-4</b>
<b>RATCHET STRAPS</b> .....	<b>13-5</b>
<b>WINCH STRAPS</b> .....	<b>13-5 TO 13-6</b>
<b>WINCHES</b> .....	<b>13-6 TO 13-7</b>
<b>WINCH PRODUCTS</b> .....	<b>13-8</b>
<b>CHAINS &amp; BINDERS</b> .....	<b>13-9</b>
<b>TARP STRAPS</b> .....	<b>13-9</b>
<b>TIE-DOWNS</b> .....	<b>13-10</b>
<b>CAB GUARD</b> .....	<b>13-10</b>
<b>TOOL BOXES</b> .....	<b>13-11</b>
<b>COIL RACK</b> .....	<b>13-11</b>

## Series E Track (10-ft Lengths)



### Horizontal

KI-43002 Painted  
KI-43001 Galvanized



### Vertical

KI-2019 Painted



### Series F Track

(Horizontal or Vertical)  
KI-2005 10'; Galvanized

## Decking / Shoring Beams

### Series E or A Aluminum Beam



Part No	Trailer Width	Adjustment
KI-FE8066-1	96"	84.6" to 95.0"
KI-FE8066-3	96" and 102"	91.9" to 102.3"

### Series E or A Heavy Duty Alum Beam



Part No	Trailer Width	Adjustment
KI-FE8000-1	96"	84.6" to 95.0"
KI-FE8000-12	96" and 102"	91.9" to 102.3"

### Series F Round Bars Galvanized Steel



Part No	Trailer Width	Adjustment
KI-1816-1	96"	79" to 93"
KI-1816-2	96" and 102"	92" to 106"

### Series F Square Bars Galvanized Steel



Part No	Trailer Width	Adjustment
KI-1818-1	96"	81" to 95"
KI-1818-2	96" and 102"	94" to 108"

# Decking / Shoring Beams



## Replacement Head

KI-FE7955-8

For FE8000 and FE8066

## Attaching Pin

KI-FE7053-1



## Trigger Repair Kit

KI-FF877



## Series E or A Wood Beam Socket

KI-1845

## Load Locks

### Round One-Piece Jack Bar



Part No	Material	Adjustment
KI-JB102	Galvanized Steel	86" to 104"

### Square One-Piece Jack Bar



Part No	Material	Adjustment
KI-JB101	Painted Steel	86" to 104"

### Square Jack Bar w/ Welded Hoop Sets



Part No	Material	Adjustment
KI-JB109	Painted Steel	86" to 104"

### One-Piece Saf-T-Bar II



Part No	Material	Adjustment
KI-10072	Galvanized Steel	88" to 105"
KI-10078	Aluminum	

## Saf-T-Lok Bar w/ Pivoting Feet



Part No	Material	Adjustment
KI-10085	Galvanized Steel	90" to 105"
KI-10088	Aluminum	

## 3-Piece Saf-T-Lok Bar w/ Pivoting Feet



Part No	Material	Adjustment
KI-10086	Aluminum	90" to 105"



### Cargo Bar Hoop Set KI-10096

24" X 29"; Steel; w/ Hardware;  
For use with  
Saf-T-Lok and Saf-T-Bar II's

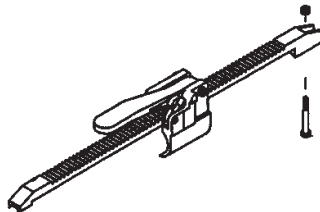

### Handle, Rack, and Housing Assembly

KI-10125-31  
For Saf-T-Lok Bars



### BarTender Cargo Bar Holder KI-10062



# Logistic Straps

## 2" Strap w/ Ratchet Buckle and FE8306-1 Spring End Fitting



Part No	Length	Buckle	Webbing
KI-641201	12'	811 Ratchet Buckle	4900 Webbing
KI-641601	16'		
KI-642001	20'		

## 2" Strap w/ Ratchet Buckle and 43020-1 3-Piece End Fitting



Part No	Length	Buckle	Webbing
KI-641202	12'	811 Ratchet Buckle	4900 Webbing

## 2" Strap w/ Cam Buckle and FE8306-1 Spring End Fitting



Part No	Length	Buckle	Webbing
KI-651201	12'	910 Cam Buckle	4900 Webbing
KI-651601	16'		

## 2" Strap w/ Cam Buckle and 43020-1 3-Piece End Fitting



Part No	Length	Buckle	Webbing
KI-651202	12'	910 Cam Buckle	4900 Webbing
KI-651602	16'		

## 2" Rope Tie-Off w/ D-Ring and FE8306-1 Spring End Fitting



Part No	Length	D-Ring	Webbing
KI-660001	6"	1027 D-Ring	4900G Webbing

## 2" Strap w/ Wide Handle Ratchet and Flat Hook End Hardware



Part No	Length	Ratchet	Flat Hook	Assembly Breaking Strength	Webbing
KI-512720	27'	804	1015	10,000 Lbs	2004
KI-513020	30'				

## 2" Strap w/ Standard Handle Ratchet and Flat Hook End Hardware



Part No	Length	Ratchet	Flat Hook	Assembly Breaking Strength	Webbing
KI-532720	27'	802	1015	5,000 Lbs	2004

## 4" Strap w/ Long Handle Ratchet and Flat Hook End Hardware



Part No	Length	Ratchet	Flat Hook	Assembly Breaking Strength	Webbing
KI-593021	30'	808	1021	16,200 Lbs	3004

# Winch Straps

## 3" Strap w/ Flat Hook End Hardware



Part No	Length	Flat Hook	Assembly Breaking Strength	Webbing
KI-322721	27'	1021-3	13,000 Lbs	3000

## 4" Strap w/ Flat Hook End Hardware



Part No	Length	Flat Hook	Assembly Breaking Strength	Webbing
KI-422721	27'	1021-3	15,000 Lbs	4000
KI-423021	30'			
KI-423421	34'			

# Winch Straps

## 4" Strap w/ D-Ring End Hardware



Part No	Length	Delta D-Ring	Assembly Breaking Strength	Webbing
KI-422710	27'	1026	15,000 Lbs	4000
KI-423010	30'			

## 4" Strap w/ Sewn Loop



Part No	Length	Assembly Breaking Strength	Webbing
KI-423030	30'	15,000 Lbs	4000



**Strap Winder**  
KI-10091

# Winches



**Standard  
Weld-On**  
KI-1820



**Standard  
Portable**  
KI-1820P2  
w/ 2 Set Screws



**Low Profile  
Weld-On**  
KI-7820



**Low Profile  
Portable**  
KI-7820P2  
w/ 1 Set Screw

## Standard Sliding Winches



**KI-3820**  
Use w/ 3606 and  
3607 Winch Tracks



**KI-1020**  
Use w/ 3608 Winch Track



**Sliding Winch**  
**AN-49246-10-SP**



**Storable  
Sliding Winch**  
**KI-5820**

## Weld-On Combination Winches



**Standard**  
**KI-13008**



**Low Profile**  
**KI-13002**



**Box Winch**  
**KI-12015**  
Webbing or Cable

## WINCH SPECIFICATIONS

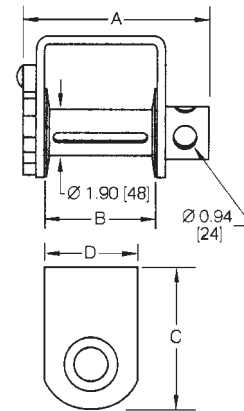

Part No	A (Inches)	B (Inches)	C (Inches)	D (Inches)	Weight (Lbs)
1020	8-1/2	5	5-7/8	4	9
1820	8-1/2	4-7/8	5-1/2	3-1/2	9.2
1820P2	8-1/2	4-7/8	5-1/2	3-1/2	10.5
3820	8-1/2	4-7/8	6	4	10.3
5820	8-1/2	4-7/8	7-5/8	4	11.7
7820	8-1/2	4-7/8	4-3/8	4	9.1
7820P2	8-1/2	4-7/8	4-3/8	4	10.5
12015	10-3/8	9-1/2	5-1/2	4	11.5
13002	10-1/16	6-1/2	4-3/8	4	10.7
13008	10-1/16	6-1/2	5-1/2	3-1/2	10.7

# Winch Products



**Standard Bar**  
KI-37030 Painted  
KI-37031 Chrome Plated



**Combination Bar**  
KI-10032 Painted  
KI-10033 Chrome Plated



**Steel Track**  
KI-3606 6'

## Aluminum Track



KI-3607 6'

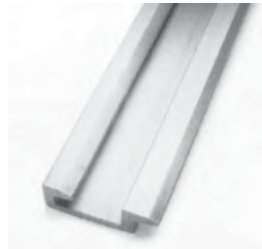

KI-3608 10'



**Steel Corner Protector**  
KI-1863

## Plastic Corner Protectors



KI-37025

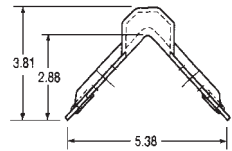
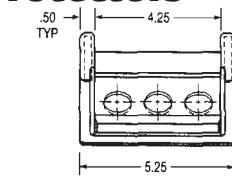

700-1-68



**Rubber Corner Protector**  
KI-37024

## 20' Chain w/ Clevis Grab Hooks



**3/8"**  
**Grade 43**  
CM-638219

**3/8"**  
**Grade 70**  
CM-639094

**5/16"**  
**Grade 70**  
CM-638284



**Clevis Grab Hook**  
**Grade 70**

CM-62373 3/8"  
CM-62273 5/16"

## Lever Binders for 3/8" and 5/16" Chain Working Load Limit: 5400 Lbs



700-1-27



700-1-63

## Ratchet Binders for 3/8" and 5/16" Chain Working Load Limit: 5400 Lbs



KI-10035

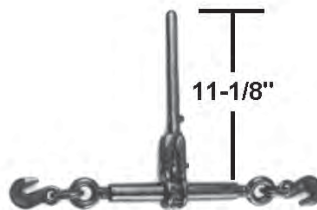

700-1-48

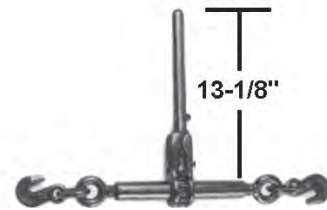

**Heavy Duty**  
700-1-44

## Tarp Straps

**Rubber Rope**  
**7/16" X 150' Roll**  
KI-10109

**Rubber Rope S-Hook**  
KI-10120



Length	EPDM Part No	Rubber Part No
9"	---	700-99-69-9R
10"	700-99-69	---
15"	700-99-70	700-99-70-15R
21"	700-99-65	700-99-65-21R
31"	700-99-66	700-99-66-31R
41"	700-99-67	700-99-67-41R

# Tie-Downs



**Pan Fitting  
w/ D-Ring  
KI-7190**

Working Load Limit: 200 Lbs

**Tie-Down Ring  
700-1-28**  
Capacity Rating: 1,200 Lbs

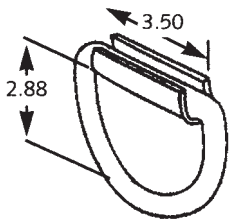
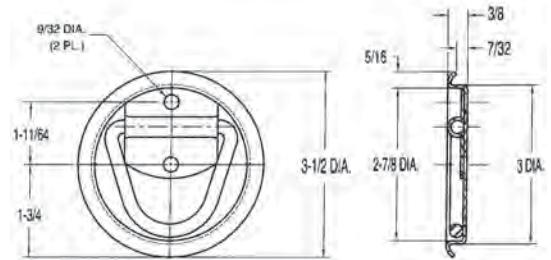

**D-Ring and Retainer  
5/8" Dia  
700-523-7**

Load Tested to 6,000 Lbs

**D-Ring  
3/4" Dia  
523-7-4**  
Pull Test: 57,500 to 62,500 Lbs;  
For 700-523-18 Retainer

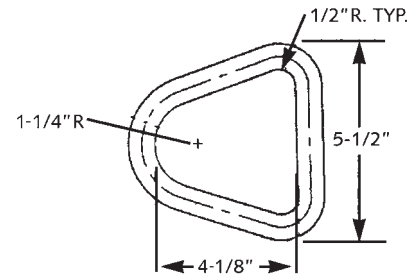

**Chain Tie-Down  
Flush-Mount  
700-1-58**

3/8" Grade 70 Chain



**Stake Pocket  
Anchor  
KI-10427-45 4-1/2"**

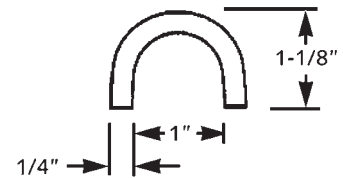

**D-Ring Retainer  
700-523-18**  
For 523-7-4 D-Ring

# Cab Guard

**Cab Guard  
Mounting Kit**

RG-68200100 17"  
RG-68200102 21"

**Aluminum  
Cab Guard  
RG-68200008**  
w/ 2 Chain Racks and  
Full Tray 68" X 86"



## Steel Tool Boxes w/ Folding T-Latch



Part No	Size
BC-1702300	18" X 18" X 24"
BC-1702303	18" X 18" X 30"
BC-1702305	18" X 18" X 36"
BC-1702310	18" X 18" X 48"
BC-1702315	18" X 18" X 60"
BC-1704300	24" X 24" X 24"
BC-1704303	24" X 24" X 30"
BC-1704305	24" X 24" X 36"
BC-1704310	24" X 24" X 48"

### Mounting Brackets (Pair)

Part No	Size
BC-1701005	18" X 18"
BC-1701015	24" X 24"

## Aluminum Tool Boxes



### Single Door

RG-68100005	24" X 24" X 48"
RG-68100006	24" X 24" X 60"

### Double Door

RG-68100024	24" X 24" X 60"
-------------	-----------------



**Mounting Brackets (Pair)**  
RG-68000903

## Miscellaneous

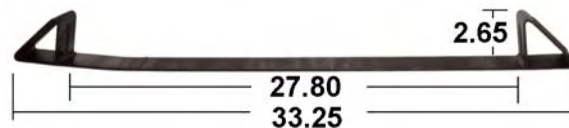

**Coil Rack**  
700-1-67





# Tools and Accessories

---

<b>AIR TOOLS</b> .....	<b>14-1 TO 14-7</b>
<b>AIR TOOL ACCESSORIES</b> .....	<b>14-8</b>
<b>BITS &amp; ADAPTERS</b> .....	<b>14-9</b>
<b>3M PRODUCTS</b> .....	<b>14-10 TO 14-11</b>
<b>HYDRAULIC JACKS</b> .....	<b>14-11</b>
<b>TRAILMOBILE CREEPER</b> .....	<b>14-11</b>

## HAMMERS



FP-610



FP-1020



FP-641



FP-610K



FP-660

Part No	Description	Blows per Min	Stroke (Inch)	Shank Opening (Inch)	Weight (Lbs)	Air Cons (CFM)
<b>FLORIDA PNEUMATIC</b>						
FP-610	Short Stroke Hammer	3,500	2-5/8	0.401	3	4
FP-610K	Short Stroke Kit (w/ 5-pc chisel set)					
FP-641	Long Stroke Hammer	2,000	3-1/2	0.401	4.5	6
FP-1020	Medium Duty Hammer	3,700	2-1/2	0.401	2.6	4
FP-660	Heavy Duty Hammer	1,800	2-7/8	0.498	3.6	4
<b>CHICAGO PNEUMATIC</b>						
CP-711	General Duty Hammer	3,500	2-5/8	0.401	3.5	4
CP-714	Heavy Duty Hammer	2,000	3-1/8	0.401	3.3	5
CP-715	Heavy Duty Hammer	2,100	3-1/2	0.401	4.5	4.5
CP-717	Extra Heavy Duty Hammer	1,800	2-11/16	0.498	4.8	7



CP-711



CP-714



CP-715



CP-717

## 3/8" IMPACT WRENCHES



Part No	Description	Bolt Capacity (Inch)	Max Torque (Ft-Lbs)	Weight (Lbs)	Air Cons (CFM)
<b>FLORIDA PNEUMATIC</b>					
FP-739	3/8" Pistol Impact	5/8	300	3.3	8
<b>CHICAGO PNEUMATIC</b>					
CP-721	General Duty Impact	3/8	75	2.6	2.5



## 1/2" IMPACT WRENCHES



Part No	Description	Bolt Capacity (Inch)	Max Torque (Ft-Lbs)	Weight (Lbs)	Air Cons (CFM)
<b>FLORIDA PNEUMATIC</b>					
FP-700	1/2" Pistol Impact --Two Hammer	3/4	700	4.5	18
FP-700L	1/2" -- 2" Extension Two Hammer	3/4	700	4.6	18
FP-734TS	1/2" Pistol Impact -- Single Hammer	9/16	375	5.3	8
FP-734TSK	1/2" Single B57 (w/ 10-pc Socket Set)				
<b>CHICAGO PNEUMATIC</b>					
CP-734H	1/2" Extra Heavy Duty Impact	9/16	425	5.2	4
CP-746	1/2" Extra Heavy Duty Impact	5/8	450	5.5	4



## 3/4" IMPACT WRENCHES



FP-775



FP-775L



FP-777



FP-777L

Part No	Description	Bolt Capacity (Inch)	Max Torque (Ft-Lbs)	Weight (Lbs)	Air Cons (CFM)
<b>FLORIDA PNEUMATIC</b>					
FP-775	3/4" Pistol Impact	1	900	11	8
FP-775L	3/4" Pistol Impact	1	900	11.5	8
FP-777	3/4" Pistol Impact	1	1,100	9	8
FP-777L	3/4" Pistol Impact	1	1,100	10.5	8
<b>CHICAGO PNEUMATIC</b>					
CP-772H	3/4" Heavy Duty Impact	1-1/8	1,000	10.5	8



CP-772H

## 1" IMPACT WRENCHES



FP-794L & FP-794LS



FP-795L

Part No	Description	Bolt Capacity (Inch)	Max Torque (Ft-Lbs)	Weight (Lbs)	Air Cons (CFM)
<b>FLORIDA PNEUMATIC</b>					
FP-794L	1" -- 6" Extension Straight Impact	1-1/4	1,400	30	16
FP-794LS	6" Extension Straight Impact (#5 Spline)	1-1/4	1,400	30	16
FP-795L	1" -- 6" Extension Straight Impact	1-1/4	1,550	16.5	12
<b>CHICAGO PNEUMATIC</b>					
CP-797-6	1" Extra Heavy Duty Impact	1-1/4	1,400	29.8	12



CP-797-6

# Air Tools

14

14-4 Tools and Accessories

## DRILLS



FP-783



FP-4050A



FP-784

Part No	Description	Free Speed (RPM)	Chuck Capacity (Inch)	Spindle Thread (Inch)	Weight (Lbs)	Air Cons (CFM)
<b>FLORIDA PNEUMATIC</b>						
FP-783	3/8" Reversible Pistol Drill	1,800	3/8	3/8-24	2.3	4
FP-4050A	3/8" Heavy Duty Pistol Drill	2,800	3/8	3/8-24	2.3	4
FP-784	1/2" Reversible Pistol Drill	500	1/2	3/8-24	3	4
<b>CHICAGO PNEUMATIC</b>						
CP-785	3/8" General Duty Drill	2,400	3/8	3/8-24	2.3	3
CP-789R-26	3/8" Extra Heavy Duty Reversible Drill	2,600	3/8	3/8-24	2.5	7.5
CP-789HR	1/2" Extra Heavy Duty Reversible Drill	500	1/2	3/8-24	3.3	7.5



CP-785



CP-789R-26



CP-789HR

## DIE GRINDERS



FP-752K



FP-753

Part No	Description	Free Speed (RPM)	Collet Size (Inch)	Motor (HP)	Weight (Lbs)	Air Cons (CFM)
<b>FLORIDA PNEUMATIC</b>						
FP-752K	Mini Angle B127 Kit (w/ 10 stones)	22,000	1/8 & 1/4	1/3	1	4
FP-753	Die Grinder	22,000	1/4	1/2	1.5	6
<b>CHICAGO PNEUMATIC</b>						
CP-860	Heavy Duty Die Grinder	24,000	1/4	1/2	1.3	5



CP-860

## RATCHETS



Part No	Description	Free Speed (RPM)	Bolt Capacity (Inch)	Max Torque (Ft-Lbs)	Weight (Lbs)	Air Cons (CFM)
<b>FLORIDA PNEUMATIC</b>						
FP-730	3/8" Heavy Duty Ratchet	200	1/2	60	2.5	4
FP-105	1/4" Cordless Ratchet (w/ Charger)	200	3/8	18	1.7	N/A
<b>CHICAGO PNEUMATIC</b>						
CP-828	3/8" Heavy Duty Ratchet	150	3/8	125	2.6	4.3



CP-828

## SANDERS



Part No	Description	Free Speed (RPM)	Pad Size (Inch)	Weight (Lbs)	Air Cons (CFM)
<b>FLORIDA PNEUMATIC</b>					
FP-896	6" Orbital Palm Sander	12,000	6	1.5	4
<b>CHICAGO PNEUMATIC</b>					
CP-778	Heavy Duty Hi-Speed Sander	14,000	5	2.3	6
CP-864	Heavy Duty Random Orbital Sander	10,000	6	4	5
CP-869S	Heavy Duty Angle Sander	5,000	7	6.5	6



## CUT-OFF TOOL



FP-3801A

Part No	Description	Strokes per Min	Cutting Capacity	Weight (Lbs)	Air Cons (CFM)
	<b>FLORIDA PNEUMATIC</b>				
FP-3801A	Cut-Off Tool	20,000	3/4" Rolled Steel	1.8	4

## AIR RIVETERS



FP-891



FP-892

Part No	Description	Pull Force (Lbs)	Weight (Lbs)	Air Cons (CFM)
	<b>FLORIDA PNEUMATIC</b>			
FP-891	3/16" Air Hydraulic Riveter	2,000	1.6	1.5
FP-892	3/16" Air Hydraulic Riveter	3,500	3.5	1.5

## LOCKBOLT GUN



FP-894K

Part No	Description	Pull Force (Lbs)	Weight (Lbs)	Air Cons (CFM)
	<b>FLORIDA PNEUMATIC</b>			
FP-894K	1/4" Lockbolt-Riveter	5,000	5	1.5

## SAW



Part No	Description	Strokes per Min	Cutting Capacity	Weight (Lbs)	Air Cons (CFM)
	<b>FLORIDA PNEUMATIC</b>				
FP-997K	Saw Kit (w/ 12 blades & 5 files)	9,000	3/8 "	1.8	4

## AIR SHEARER



Part No	Description	Strokes per Min	Cutting Capacity	Weight (Lbs)	Air Cons (CFM)
	<b>FLORIDA PNEUMATIC</b>				
FP-982	Pistol Shear	2,200	18 Gauge	5	4



# Air Tool Accessories



## ACCESSORIES FOR HAMMERS (.401" Shank)

FP-610, FP-641, & FP-1020;  
CP-711, CP-714, & CP-715

Item	Part No	Description
1	CP-A046050	Rivet Cutter
2	CP-A046071	Twin Blade Panel (Pipe) Cutter
3	CP-A046073	Cold Chisel
4	CP-A046076	Edging Chisel
5	CP-A046078	Tapered Punch
6	CP-A046087	Rivet Set 1/8" Round Head
	CP-A046088	Rivet Set 3/16" Round Head
	CP-A046089	Rivet Set 1/4" Round Head
7	CP-A046090	Smoothing Hammer 1" Face
8	CP-A046094	Zip-Quick Retainer
9	CP-A046096	Bee-Hive Retainer

## Rivet Sets (.401" Shank)

Part No	Application
TA-S720	3/16" Brazier Head
TA-S721	1/4" Brazier Head
TA-S722	3/16" Modified Brazier Head
TA-S723	1/4" Modified Brazier Head
TA-S729	3/8" Brazier Head
TA-S731	3/16 Universal Head
TA-S821	Tubular (Roll-Up Door)



**Protecto-Lube**  
CP-CA000046



**3" Cut-Off Wheel**  
CP-CA155312



## ACCESSORIES FOR HAMMERS (.498" Shank)

FP-660 & CP-717

Item	Part No	Description
1	CP-A047050	Rivet Cutter
2	CP-A047051	Wide Cutting Chisel
3	CP-A047078	Tapered Punch
4	CP-A047095	Quick-Change Retainer

## Drill Bits



Size	Pkg Qty	XGO Series	705 Series	
		135 Degree Split Point	118 Degree Point	135 Degree Split Point
		Part No		
1/16	12	DB-HQ1/16	---	---
5/64	12	DB-HQ5/64	---	---
3/32	12	DB-HQ3/32	---	---
7/64	12	DB-HQ7/64	---	---
1/8	12	DB-HQ1/8	DB-EC1/8	DB-705SP-1/8
9/64	12	DB-HQ9/64	---	---
5/32	12	DB-HQ5/32	DB-EC5/32	DB-705SP-5/32
11/64	12	DB-HQ11/64	DB-EC11/64	DB-705SP-11/64
3/16	12	DB-HQ3/16	DB-EC3/16	---
13/64	12	DB-HQ13/64	DB-EC13/64	---
7/32	12	DB-HQ7/32	DB-EC7/32	DB-705SP-7/32
15/64	12	DB-HQ15/64	---	---
1/4	12	DB-HQ1/4	DB-EC1/4	DB-705SP-1/4
17/64	12	DB-HQ17/64	DB-EC17/64	DB-705SP-17/64
9/32	12	DB-HQ9/32	DB-EC9/32	DB-705SP-9/32
19/64	6	DB-HQ19/64	---	---
5/16	6	DB-HQ5/16	DB-EC5/16	DB-705SP-5/16
21/64	6	DB-HQ21/64	---	---
11/32	6	DB-HQ11/32	DB-EC11/32	DB-705SP-11/32
23/64	6	DB-HQ23/64	---	---
3/8	6	DB-HQ3/8	DB-EC3/8	DB-705SP-3/8
25/64	6	DB-HQ25/64	---	---
13/32	6	DB-HQ13/32	---	---
27/64	6	DB-HQ27/64	---	---
7/16	6	DB-HQ7/16	---	DB-705SP-7/16
29/64	6	DB-HQ29/64	---	---
15/32	6	DB-HQ15/32	---	---
31/64	6	DB-HQ31/64	---	---
1/2	6	DB-HQ1/2	---	---
5/8	6	---	---	---
0.189	12	---	---	DB-705SP-12
0.191	12	---	DB-EC11	---
0.1935	12	DB-HQ10	---	DB-705SP-10
0.257	12	---	---	DB-705SP-F
0.261	12	DB-HQG	---	---



### Bit Holder 1/2" Square Drive

Part No	Hex Size
TA-858	1/4"
TA-855	5/16"



### Torx Bits

Part No	Hex Size
TA-440TX25	1/4"
TA-440TX30	
TA-480TX30	5/16"
TA-480TX40	
TA-480TX50	
TA-480TX55	



### Phillips Bits

Part No	Hex Size	Point Size
TA-4802	5/16"	No. 2
TA-4803		No. 3



### Square Bit

Part No	Hex Size	Point Size
TA-9502	1/4"	No. 2

# 3M Products



## Roloc Discs

Part No	Dia	Grade
3M-01397	2"	36
3M-01407	3"	
3M-01408		24

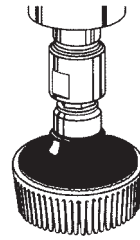

## Roloc Bristle Discs

Part No	Size	Grade
3M-07524	2"	50

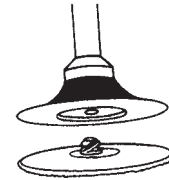

## Roloc Disc Pad Assemblies

Part No	Size
3M-05539	2"
3M-05540	3"
3M-05541	4"



## Green Corps Fibre Discs

Part No	Dia	Grade
3M-01914	5"	36
3M-01915		24

## CUT-OFF WHEELS



## General Purpose

Part No	Size
3M-01987	3" X 1/32" x 3/8"
3M-01988	3" X 1/16" x 3/8"



## Green Corps

Part No	Size
3M-01989	3" X 1/32" x 3/8"
3M-01990	3" X 1/16" x 3/8"



## Stikit Gold Disc Rolls

Part No	Dia	Grade
3M-01437	6"	P240



## Mechanics Abrasive Rolls

Part No	Size	Grade
3M-05150	1" X 60'	320
3M-05152		240
3M-05158		80
3M-05169	1-1/2" X 60'	

## Cloth Utility Rolls



Part No	Size	Grade
3M-05006	1" X 150'	180
3M-05010		80
3M-05022	1-1/2" X 150'	320
3M-05026		180
3M-05030		80
3M-05050		

## SCOTCH-BRITE



### General Purpose Pads

Part No	Size
3M-07447	6" X 9"



### Surface Conditioning Pads

Part No	Size	Grade
3M-07480	2"	Coarse
3M-07481		Medium
3M-07485	3"	Coarse
3M-07486		Medium
3M-07450	4"	Coarse

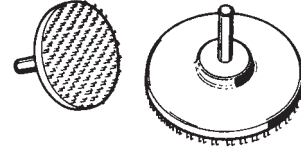

### Disc Pads

Part No	Size
3M-07492	4"



### Clean & Strip Disc

Part No	Size
3M-07466	4" X 1/2"

## Miscellaneous



### Hydraulic Hand Jacks

Part No	Capacity	Min Height	Max Height	Extension Screw Travel	Jack Size
700-99-164	12 Ton	9-3/8"	18-1/2"	3-1/8"	5-1/4" (L) X 5-1/8" (W)
700-99-165	20 Ton	9-1/2"	18-5/8"		6-1/4" (L) X 5-7/8" (W)



### Trailmobile Creeper 700-99-24



# Adhesives, Sealants, and

---

<b>CAULKING</b> .....	<b>15-1</b>
<b>ROOF SEALANTS</b> .....	<b>15-2</b>
<b>TAPE &amp; REPAIR KITS</b> .....	<b>15-3 TO 15-4</b>
<b>FLOOR RESTORE KITS</b> .....	<b>15-4</b>
<b>LOCTITE – PERMATEX</b> .....	<b>15-5 TO 15-6</b>
<b>3M PRODUCTS</b> .....	<b>15-7 TO 15-9</b>



**Adhesive Sealant  
10.1 Oz Cartridges**

Part No	Color
700-99-132	Gray
700-99-133	Off-White
700-99-333	Super White

**SILAPRENE**



**SolidSeal  
10.3 Oz Cartridges**

Part No	Color
700-99-415	Gray
700-99-416	White



**Transportation  
10.1 Oz Cartridges**

Part No	Color
700-99-417	Gray
700-99-419	Super White



**Adhesive Sealant  
11 Oz Cartridges**

Part No	Color
MA-65-A-GRAY	Gray
MA-65-A-WHITE	White

**MANUS**



**Silicone  
Adhesive/Sealant  
10.3 Oz Cartridges**

Part No	Color
MA-73-A-BLACK	Black
MA-73-A-CLEAR	Clear
MA-73-A-GRAY	Gray
MA-73-A-WHITE	White



**Synthetic Rubber  
Sealant  
11 Oz Cartridges**

Part No	Color
MA-501-A-GRAY	Gray
MA-501-A-WHITE	White



**Sealant  
Self-Leveling  
10.3 Oz Cartridges**

Part No	Color
MA-30-A-GRAY	Gray
MA-30-A-WHITE	White



**Caulking Gun  
700-99-515**

# Roof Sealants



## Roof Repair Kit

700-99-8

- Roof Repair Kit Contains:
- 2 one-gallon cans of Sealing Mastic (700-99-7)
  - 1 one-gallon can of Aluminum Coating (700-99-6)
  - 2 Applicators
  - 1 roll Glass Fabric Membrane 4" X 150"



### Sealing Mastic Black Plastic Cement

700-99-7 1 Gallon



### Aluminum Coating

700-99-6 1 Gallon



Can be applied to wet or dry surfaces

### Aluminum Gray Sealer

MA-65-B Brush Grade; 1 Gallon  
MA-65-H Trowel Grade; 1 Gallon



Can be applied to wet or dry surfaces

### Aluminum Sealer Self-Leveling

MA-76-AM 1 Gallon



Can be applied to wet or dry surfaces

### Seal Gap

700-99-483 1 Gallon

## Foam Panel Sealing Tape



**50-109-13-1**  
1/16" X 1/4" X 200' Roll

**700-99-128**  
3/32" X 3/4" X 100' Roll

**50-71-83-3-15**  
3/4" X 1" X 15' Roll

## Gray Butyl Roof Bow Tape



**MA-64-A**  
1/8" X 5/8" X 65' Roll

**50-71-23**  
1/8" X 3/4" X 50' Roll  
(Parr)



**Adhesive Tape**  
**50-71-105B**  
3/64" X 3/4" X 600' Roll



**Mylar Tape**  
**700-99-283** 4" X 216'  
**700-99-140** 6" X 216'

## Aluminum Foil Patch Tape

**700-99-186** 4" X 30'  
**MA-ALUM-A-FOIL** 4" x 50'  
**MA-WHITE-FOIL** 4" X 50'; White  
**700-99-193** 6" X 30'



**Kargo Patch**  
**700-99-343-BULK**



Quick Cure Fiberglass Repair Kit  
Cures in 10 Minutes; No Mixing – No Mistakes;  
No Mess; Bonds to Fiberglass, Metal, Wood, &  
Most Plastics; Not affected by Temperature &  
Water; UVA Activated



**Kemlite Sun Patch**  
**for Translucent Roofs**  
**700-99-401**

Repairs Small Tears and  
Punctures;  
Cures in 10 Minutes after  
Exposure to UV Rays;  
Works in Hot or Cold  
Climates (0 to 100°F);  
No Mixing of Resin Required



# Tape & Repair Kits



## Adhesive-Backed Repair Panels

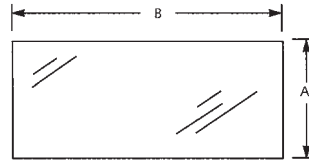

### Vanfastic

Part No	Material	Color	A	B
700-99-339	Aluminum	White	12"	12"
700-99-340				24"
700-99-341		Bare		12"
700-99-342				24"

### Flexan

Part No	Material	Color	A	B
700-99-373	Clear Lexan	Translucent Roof Repair	12"	24"
700-99-374	White Lexan	FRP Repair		



1-Gallon Container

### Two-Component Structural Strength Epoxy Adhesive (83220ABWH) 700-99-150

Applications:  
Scuff Sheet Installation;  
Reefer Panel Repair;  
Logistic Track Installation



1-Quart Container

### Two-Component Quick Patch Epoxy Repair Kit (QP300) 700-99-260

Applications:  
Epoxy for repair of small areas like gouges, nicks, and scratches

## Floor Restore Kits



1-Quart Container

### Two-Component Epoxy Floor Patch and Crack Filler (FP100ABQCF) 700-99-201

Applications:  
Fills gouges and cracks in wood floors before overall coating with Floor Restore



### Clear Floor Restore Kit Solvent Free (EC1055ABSFK) 700-99-319 48' Trailer 700-99-319-53 53' Trailer



**Medium Strength Threadlocker BLUE**  
LT-24200 6 ML Tube



**High Strength Threadlocker RED**  
LT-27100 6 ML Tube  
LT-27140 36 ML Bottle  
LT-27010 10 G Gel



**Thread Sealant w/ Teflon**  
LT-80632 4 Oz Can



**PST Pipe Sealant w/ Teflon Industrial Grade**  
LT-56521 50 ML Tube



**Black Silicone Adhesive Sealant**  
LT-81158 3 Oz Tube



**Clear Silicone Adhesive Sealant**  
LT-80050 3 Oz Tube



**Super Weatherstrip Adhesive**  
LT-81731 5 Oz Tube



**Undercoating**  
LT-80072 20 Oz Aerosol Can



**Heavy Duty Rubberized Undercoating**  
LT-81833 20 Oz Aerosol Can

# Loctite - Permatex



**Form -A-Gasket  
No. 2 Sealant**  
LT-80016 3 Oz Tube



**Right Stuff  
Gasket Maker**  
LT-99070  
5 Oz Cartridge



**Ultra Black  
Gasket Maker**  
LT-82180 3.35 Oz Tube



**Sensor-Safe  
BLUE Silicone  
RTV Gasket**  
LT-80022 3 Oz Tube



**Ultra BLUE  
Silicone No-Leak  
RTV Gasket**  
LT-81724 3.35 Oz Tube



**Ultra COPPER  
High-Temp Silicone  
RTV Gasket**  
LT-81878 3 Oz Tube



**Anti-Seize  
Lubricant**  
LT-81464  
12 Oz Aerosol Can  
LT-80078  
8 Oz Brush-Top Bottle



**Ultra-Slick  
Synthetic  
Multi-Purpose  
Lubricant w/ PTFE**  
LT-81943  
12 Oz Aerosol Can



**Decal & Paint  
Stripper**  
LT-80577  
16 Oz Aerosol Can

**Masking Tape**



**Beige**  
3M-06334  
3/4" X 60 Yds  
3M-06340  
2" X 60 Yds

**Green**  
3M-26334  
18 MM X 55 M  
3M-26340  
48 MM X 55 M



**Cloth Duct Tape**  
3M-06969  
2" X 60 Yds; Silver  
3M-06975  
2" X 60 Yds; Silver; Heavy Duty

**Electrical Tape**



**Vinyl**  
3M-49656  
3/4" X 60'

**Vinyl Plastic**  
**Super 33+**  
3M-06133  
3/4" X 52'



**Acrylic Foam Tape**  
**Scotch-Mount**  
3M-06380  
1/2" X 20 Yds; White  
3M-06382  
1/2" X 20 Yds; Gray



**Tape Dispenser**  
**Pistol Grip**  
3M-06997



**Super Glue**  
**(Gel)**  
3M-08751 0.7 Oz



**Stripe Adhesive**  
**Remover**  
3M-08908 24 Oz

# 3M Products



**Body Schutz Coating (Black)**

3M-08864 1 Qt  
3M-08964 24 Oz



**Undercoating Spray (Black)**

3M-08881 20 Oz



**Weld-Thru Coating 3M-05913**



**Strip Caulk (Black) 3M-08578**



**Window-Weld Resealant (Black) 3M-08634 10 Oz**



**Clear Auto Sealer 3M-08551 5 Oz**

## Automix Adhesives

Part No	Work Time	Size
3M-08270	1.5 Minute	400 ML
3M-08217	3 Minutes	200 ML
3M-08271		
3M-08272	10 Minutes	400 ML
3M-08275		
3M-08276		
3M-08277	35 Minutes	
3M-08273		



**Automix Nozzles 3M-08193 6-Pack**



**Spray Disc Adhesive**  
3M-08054 8 Oz



**Feathering Disc Adhesive**  
3M-08051 5 Oz



**Fast Tack Trim Adhesive**  
3M-08031 5 Oz



**Super Trim Adhesive**  
3M-08090 19 Oz



**Urethane Adhesive (Black)**  
3M-08609 10 Oz



**Weather Strip Adhesive**  
3M-08001 5Oz; Yellow  
3M-08008 5 Oz; Black



# Lubricants and Chemicals

---

<b>LUBRICANTS</b> .....	<b>16-1</b>
<b>SHELL PRODUCTS</b> .....	<b>16-2 TO 16-3</b>
<b>WINDSHIELD WASHER FLUID</b> .....	<b>16-3</b>
<b>CHEMICALS, INCLUDING SPRAY PAINT</b> .....	<b>16-3 TO 16-4</b>
<b>WINTER CHEMICALS</b> .....	<b>16-5</b>

**Roller Door Lube**



**Trailmobile**  
700-99-331  
9 Oz



**Todco**  
TO-39000-1012  
12 Oz



**Todco**  
TO-39000-1016  
1 Gal

**WD-40**



700-99-388  
11 Oz



700-99-389  
1 Gal



700-99-387  
48 11-Oz Cans  
w/ Point-of-Purchase Display



**CRC Power Lube**  
700-99-203 9 Oz



**Dri-Slide Lubricant**  
700-99-479 5.25 Oz



# Shell Products



**Rotella T  
15W-40 Oil**  
PP-5001200055  
55 Gal  
PP-5001205203  
5 Gal  
PP-5001206021  
1 Gal



**Rotella T  
50 HD Diesel Oil**  
PP-5415005203  
5 Gal



**Spirax HD  
Gear Oil**  
PP-5921200120  
85W-140; 120 Lbs  
PP-5921212091  
85W-140; 35 Lbs  
PP-5921235203  
75W-90; 35 Lbs



**Dentax 80W-90  
Transmission Fluid**  
PP-5900300120  
120 Lbs  
PP-5900335203  
35 Lbs



**Dentax SAE 50  
Synthetic  
Transmission Fluid**  
PP-5900735203  
35 Lbs



**Tellus PLUS  
32 Hydraulic Oil**  
PP-5061253  
55 Gal  
PP-5061282  
5 Gal



**Retinax LC  
Grease**  
PP-7042835203  
35 Lbs  
PP-7042830141  
14 Oz



**Retinax TL 00  
Synthetic Grease**  
PP-7046035203  
35 Lbs



**Multi-Purpose  
Grease**  
PP-7112502120  
120 Lbs  
PP-7112530141  
14 Oz

**Anti-Freeze Concentrate**



PP-9401000055  
55 Gal  
PP-9401006021  
1 Gal

**Extended Life**  
PP-9404206021  
1 Gal

**Windshield Washer Fluid**



700-99-492-1GAL  
1 Gal  
700-99-492-55GAL  
55 Gal

**Chemicals**



**Foam Insulation Kits**

Part No	Coverage (Board Feet)
700-99-425-12	12
700-99-425-22	22
700-99-425-105	105
700-99-425-205	205
700-99-425-605	605

Kit includes:

Applicator and dispensing nozzles



**Enamel Spray Paint  
12-Oz Aerosol Cans**

Part No	Color
700-99-38	Aluminum
700-99-45	Non-Smudge Aluminum
700-99-39	Black
700-99-44	Flat Black
700-99-68	Light Gray Primer
700-99-41	Red Primer
700-99-42	Red
700-99-43	White



**Aluminum Cleaner  
and Brightener**

700-99-130 1 Gal  
700-99-169 55 Gal



Environmentally  
Safe

**Enamel Spray Paint  
Hi Solid /  
VOC Compliant  
12-Oz Aerosol Cans**

Part No	Color
700-99-306	Aluminum
700-99-307	Black
700-99-312	Light Gray Primer
700-99-314	Gray
700-99-308	Red Primer
700-99-309	Red
700-99-310	White



**Heavy Duty  
Truck Wash**

700-99-129 1 Gal  
700-99-168 55 Gal

**CRC Brake Parts Cleaner**



700-99-202  
19-Oz Aerosol Cans

**Non-Chlorinated  
(California Compliant)**  
700-99-202CA  
15-Oz Aerosol Cans



**Graffiti /  
Paint Remover**  
700-99-313  
20-Oz Aerosol Cans



**Glass Cleaner**  
700-99-330 18 Oz



**Starting Fluid**  
700-99-322 11 Oz



**Air Brake Conditioner**  
700-99-324 32 Oz



**Diesel Fuel Anti-Gel**  
700-99-329 12 Oz



**Diesel Fuel Conditioner  
w/ Anti-Gel**  
700-99-328 30 Oz



**Ice-Off  
Spray De-Icer**  
700-99-323 12 Oz



# Miscellaneous

---

<b>REGISTRATION HOLDERS .....</b>	<b>17-1 TO 17-2</b>
<b>SECURITY SEALS .....</b>	<b>17-2</b>
<b>SHOP TOWELS &amp; HAND CLEANER .....</b>	<b>17-3</b>
<b>TRAILMOBILE DECALS .....</b>	<b>17-3</b>
<b>HYCO HYDRAULIC CYLINDERS .....</b>	<b>17-4</b>
<b>GLOVES .....</b>	<b>17-4 TO 17-5</b>
<b>BROOMS &amp; BRUSHES .....</b>	<b>17-6 TO 17-7</b>
<b>PLASTIC BAGS WITH TRAILMOBILE LOGO .....</b>	<b>17-7</b>
<b>PARTS BIN LABELS .....</b>	<b>17-7</b>
<b>MARKERS .....</b>	<b>17-7</b>



**Aluminum  
Manifest Box**  
700-99-1

1-1/4" X 8" X 13";  
Spring Clip Inside Sealable Latch

## Model 300 Aluminum Security Box



**JK-300**

Outside: 5-1/4" X 7" X 2"  
Clip Board: 3-1/2" X 5-1/4"

700-99-452 Generic



**Replacement Lid**  
JK-300LID



**Aluminum  
Tube-Type Holder  
w/ Cap Keeper**  
700-99-380

700-99-451 Generic

700-50-15  
Replacement Cap

## Model 350 Plastic Security Box



**JK-350**

Outside: 5-1/4" X 7" X 2"  
Inside: 3-1/2" X 5" X 1"



**Replacement Lid**  
JK-350LID

## Plastic Record Box



**Model 45  
Certificate Holder**  
PM-45

Frame: 7-1/4" X 4-7/8"  
Pouch: 7" X 4-5/8"



**Model 500**  
JK-500

Outside:  
11-1/2 X 16" X 1-1/2"  
Inside:  
10" X 14" X 1-1/2"

**Model 550**  
JK-550

Outside:  
10" X 15" X 1-1/4"  
Inside:  
9-1/2" X 12-1/4" X 3/4"

# Registration Holders

## Truck-Lite Plastic Document Holder



TL-97960



**Replacement Cover  
w/ Gasket**  
TL-97962

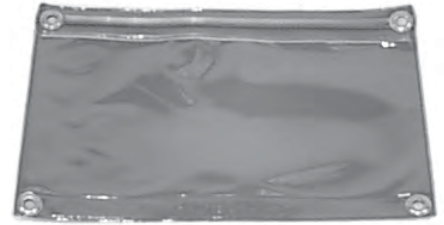

**Grote  
Vinyl Permit Holder**  
GR-43411  
8-7/8" X 5-7/8"

## PS-1 Type Document Holder



700-99-448



**Replacement Lid  
w/ O-Ring**  
700-99-450

## Security Seals



**Metal**  
700-99-125



**Plastic**  
700-99-254

## Shop Towels



**On a Roll**  
700-99-347  
55 Shop Towels per Roll



**In a Box**  
700-99-348  
Dispensing Carton;  
200 Wipes; 10" X 14" Each



**Shop Rags In a Box**  
700-99-350  
Dispensing Carton;  
200 Wipes; 10" X 14" Each

## Kwik Wipes



**Canister**  
700-99-354  
70 Wipes



**Bucket**  
700-99-357  
130 Wipes; 10" X 12" Each



**Fast Orange Hand Cleaner**  
LT-25218  
1-Gal Bottle w/ Pump



**Kresto EF Hand Cleaner**  
700-99-358  
2000 ML; Soft Bottle

## Trailmobile Decals



**Wing Decal**  
33-1-198  
4-1/2" X 24"

33-1-255  
2.44" X 13.20"



# Hyco Hydraulic Cylinders

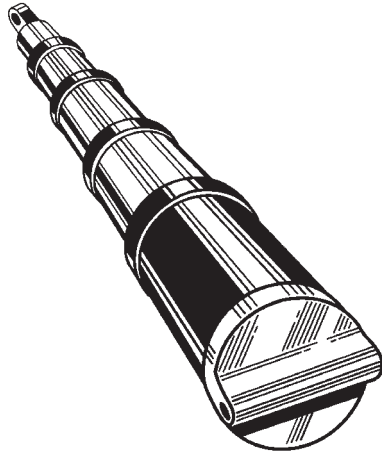

Part No	Type	Stroke	Closed Length	Extended Length
HY-70000-814-155D	4-Stage	155"	55.75"	210.75"
HY-70000-815-180D	5-Stage	180"	54"	233.25"
HY-70000-815-180DE				
HY-70000-815-210D		210"	60"	269.25"
HY-70000-815-210DE				
HY-70022-815-210D		235"	65"	299.25"
HY-70000-815-235D				
HY-70000-815-250D		265"	71"	335.25"
HY-70000-815-265D				
HY-70000-815-265DE				

## Gloves



**Cotton Canvas  
Chore  
GL-02**



**Yellow  
18-Oz Cotton Flannel  
Chore  
GL-04**

### Brown Jersey



**9-Oz  
GL-01**



**9-Oz w/ Grip Dots  
GL-05**



**Heavy-Weight  
w/ Red Cotton Lining  
GL-03**



**Unlined Leather Driver**

**Quality Split Leather**  
GL-07L



**Select Grain Leather**  
GL-08L



**18" Heavy Duty Natural Rubber**  
GL-13  
50 mil Thickness



**Lined Leather Driver**

**Split Leather**  
GL-09L  
w/ Foamed Insulation;  
Velcro Wrist Strap



**Premium Grain Cowhide**  
GL-10L  
w/ Brushed Tricot-Over-Foam Lining



**Golf**  
GL-18L  
GL-18XL  
White Synthetic Leather;  
Velcro Closure on Back



**Leather Palm**

**Premium Split Leather**  
GL-06



**Womens Split Leather**  
GL-12  
w/ Safety Cuff; Yellow

**Latex Powdered**  
GL-15M  
GL-15L  
GL-15XL



100 per box

**Nitrile Powdered**  
GL-16M  
GL-16L  
GL-16XL

**Latex Powder-Free**  
GL-15M-PF  
GL-15L-PF  
GL-15XL-PF

**Nitrile Powder-Free**  
GL-16M-PF  
GL-16L-PF  
GL-16XL-PF

# Brooms & Brushes

## Broom Heads

**24" Fine Sweep**  
CL-432224

**24" Medium Sweep**  
CL-436524

**24" Heavy Sweep**  
CL-438224



**18" Oil / Grease Sweep**  
CL-439618

**24" Medium Sweep Reeper Floor**  
CL-435724R1

**24" Heavy Sweep Reeper Floor**  
CL-437924R

## Handles



**Wood**  
CL-4390160H  
1-5/16" X 60"

CL-4385HPL  
1-1/8" X 60"; Reinforced

**Aluminum Extension Handle**  
CL-43380144H  
6' to 12'

**Squeegee Handle**  
CL-43248HAS  
1-1/8" X 60"



**Broom Brace**  
CL-43-87  
For 18" to 36" Broom Heads



**Scrub Brush Head**  
CL-43887510  
10" Tri-Level; Heavy Duty



**Squeegee Head**  
CL-4324836  
36" Straight; Rubber

## Wash Brush Heads



**8" Nylon**  
CL-43681208X

**10" Nylon**  
CL-43681210X

**14" Soft Nylon**  
CL-43685514



**Corn Broom**  
CL-100



**Aluminum  
Dust Pan**  
CL-485 16"



**Wash Mitt**  
CL-553 7" X 10"



**Heavy Duty  
Degreasing Cleaner**  
CL-70305 Gal

**Miscellaneous**

**Plastic Bags  
w/ TM Logo**

- 700-99-55 4" X 7"
- 700-99-56 8" X 10"
- 700-99-57 10" X 12"
- 700-99-152 12" X 16"



**Parts Bin Labels**  
700-99-108

**Markers**

- 700-99-151  
Yellow Opaque
- 700-99-151B  
Black